

red  
light

16

## INDEX

22/136 Office

32 Schirmleuchten  
Shade luminaires

44 Leuchtenfamilien  
Luminaire families

144 Strahler  
Spotlights

156 SCHMITZ@HOME

168 Lineare Systeme  
Linear systems

212 Einbauleuchten und  
Einbausysteme  
Recessed luminaires  
and systems

Index nach Leuchtennamen  
auf der Klappeninnenseite.

Index by name on the back.



# red light 16

Wir glühen für Licht – und die Leuchten, die wir für Ihre Objekte entwerfen, produzieren und vertreiben. Dabei verstehen wir die Leuchte als Medium für die Implementierung von Licht – und als gestalterisches Element, das mit der Architektur in Interaktion tritt. Entdecken Sie, wie Sie mit unseren Leuchten Ihre Lichtkonzepte umsetzen können.

We are aglow with passion for light – and the luminaires we design, produce and distribute for your buildings. We see luminaires as a medium to feature light – and as creative design elements interacting with architecture. Discover how you can use our luminaires to realize your lighting concepts.

## red light 16

- 8 Elementares Licht / Elementary light
- 10 Lineares Licht / Linear light
- 12 Integriertes Licht / Integrated light
- 14 Serielles Licht / Serial light
- 16 LEO-Licht emittierende Optik / LEO-light emitting optics
- 18 Tunable White / Tunable white
- 20 Intelligente Beleuchtung / Intelligent lighting

### Office

22 PARO



136 FACTORY



136 FACTORY



### Schirmleuchten / Shade luminaires

32 ROTONDA LED

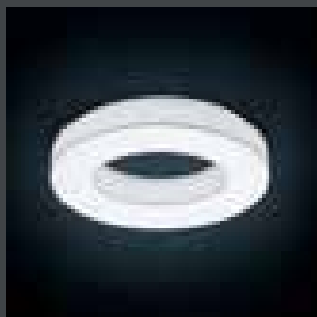

### Leuchten / Luminaires

44 CALVIA



50 CORUM



58 QUATTRA



64 CLEAR | CLEAR 2



64 CLEAR | CLEAR 2

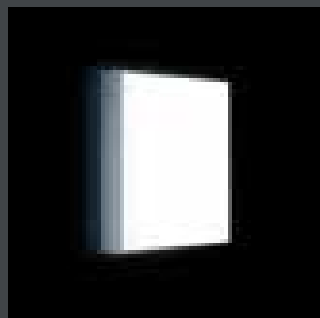

84 STEN





88 CLOUD



92 INSIDE



100 SLIM

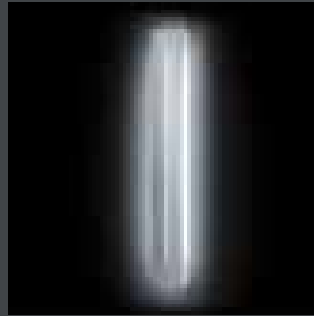

104 GAME



108 TOOL | TOOL 2



120 PEARL

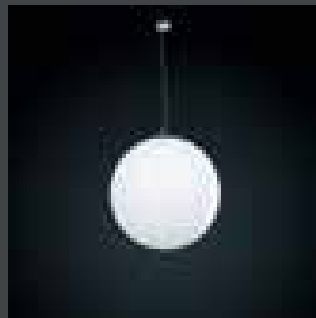

126 TURN



130 TENDO 1

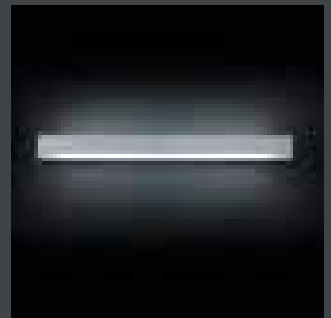

**Strahler / Spotlights**

144 SPOT

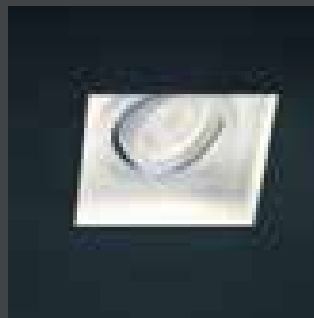

152 CAM 7



156 SCHMITZ@HOME



Lineare Systeme / Linear systems

168 SYSTEM 40 | 40+



184 TENDO 1



188 TENDO 2



194 STRONG 1 | 2 | 3



208 SIZE

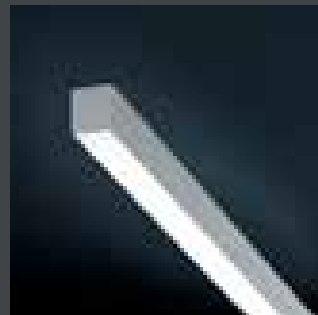

Einbauleuchten und Einbausysteme / Recessed luminaires and systems

212 TZ-T



222 TECTO

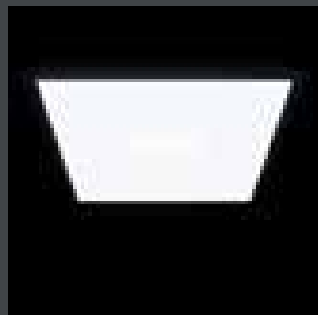

226 TZ-4

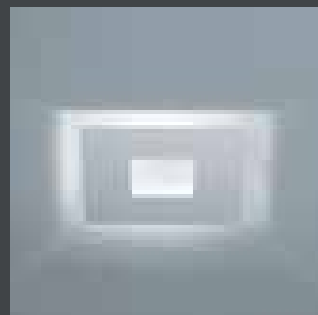
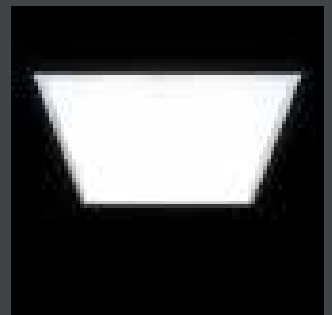

Einbauleuchten und Einbausysteme / Recessed luminaires and systems

238 TZ-5



242 TZ-6

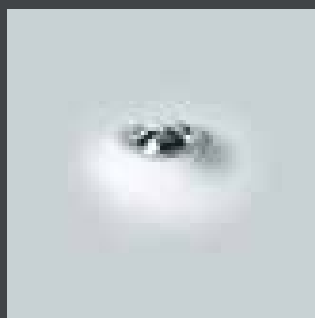

252 TZ-50 | TZ-51



256 TZ-55 | TZ-56

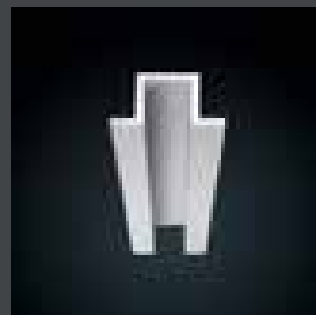

260 TZ-57

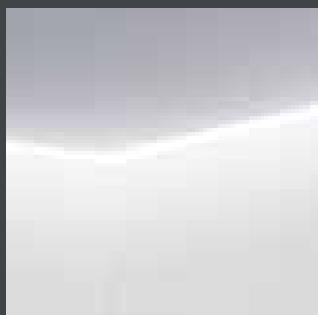

264 TZ-60

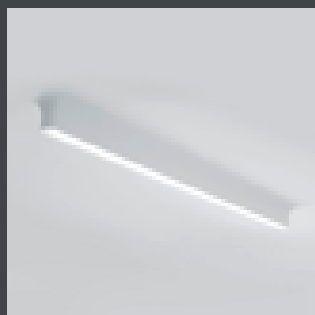

268 TZ-100 | TZ-101



276 TZ-200





Elementares Licht

Elementary light



**Elementares Licht bedeutet für uns Form und Wirkung, Leuchten und Licht.**

Die klare Formensprache unserer Leuchten integriert sich wie selbstverständlich in die Architektur und inspiriert gleichzeitig zu eigener Gestaltung. Erst Licht macht Räume erlebbar. Im Vordergrund steht dabei immer die Raumidee und -wirkung, die mit Licht von SCHMITZ auf den Punkt gebracht wird.

**For us elementary light means form and effect, luminaires and light.**

The clear design language of our luminaires integrates itself completely naturally into the architecture and at the same time inspires to a form of design of its own. Because it is only possible to live in rooms once they have light, the idea of space and its effect always takes prominence, and this is epitomised with light from SCHMITZ.



Richtung weisen

Giving direction



## Lineares Licht

Jede Planung beginnt mit einem ersten Strich. Vollendung erfährt die Architektur durch eine Linie – in Form einer linearen Beleuchtung. Als Gestaltungselement ist die lineare Systembeleuchtung ebenso offen wie der freihändig geführte Stift: in oder an der Decke als Grundbeleuchtung, abgehängt zur gezielten Beleuchtung einzelner Bereiche oder als Wandleuchte zur Akzentuierung und Orientierung. Mit Leuchtensystemen von SCHMITZ können alle Optionen in einheitlichem Design realisiert werden. Funktional und gestalterisch perfekt aufeinander abgestimmt, werden die einzelnen Beleuchtungskomponenten so zu einem qualitätssteigernden Bestandteil der Architektur.

## Linear light

Every plan starts by drawing a first line. A line brings architecture to perfection – in the form of linear lighting. As a design element, linear system lighting is just as versatile as a pencil in freehand drawing: in or on the ceiling as general lighting, as a pendant for targeted illumination of selected areas or as a wall light for accentuation and orientation. With lighting systems from SCHMITZ, all options are available in a uniform design. In this way, the individual lighting components are combined into a quality-enhancing feature of the architecture – functional and in perfect harmony with each other.







### **Integriertes Licht**

Es entspricht der natürlichen Wahrnehmung, dass Licht von oben kommt. Während in der Natur der Himmel die Grenze für die Gedanken ist, wird der Raumdecke allerdings wenig Beachtung geschenkt. Doch gerade die Kombination mit Licht macht sie zur relevanten Fläche in der Architektur – positiv begrenzend, dezent funktional oder bewusst zonierend. SCHMITZ Gipseinbausysteme gehen noch einen Schritt weiter. Durch Gipsmodule lassen sich die Leuchten ansatzlos vor oder hinter der Decke platzieren – mit verblüffendem Effekt. Die Decke bekommt eine dritte Dimension und wandelt sich von der Ebene zur gestaltbaren Fläche. Geformt für und durch die direkte sowie indirekte Beleuchtung.

### **Integrated light**

It corresponds to the natural experience that light comes from above. While in nature the sky is the limit for thoughts, the ceiling of a room usually receives little attention. But the combination with light is what makes it a significant part of the architecture – setting positive boundaries, unpretentiously functional or deliberately creating zones. SCHMITZ gypsum installation systems take it a step further. With the help of gypsum modules, the light fittings can be installed seamlessly either in front of or behind the ceiling – with an amazing effect. The ceiling is given a third dimension and thus transformed from a mere plane into an area for design. Shaped for and by direct and indirect lighting.



Licht gestalten  
Designing light



### **Serielles Licht**

Das Wesen des Lichtes fasziniert. Gegenstandslos und dennoch gestaltend wie gestaltbar. Die Herausforderung liegt darin, Licht und Ort aufeinander abzustimmen. Die Leuchte dient dabei als Medium. Leuchtenfamilien von SCHMITZ sind wie das Licht: präsent und doch wandelbar. Das stringente Design in unterschiedlichen Formen und Größen fügt sich selbstverständlich in jede Architektur ein. Mit unterschiedlichen Bestückungen und Montagemöglichkeiten transformieren sie das Licht zur prägenden Beleuchtung.

### **Serial light**

The essence of light is fascinating. Shapeless and yet capable of shaping and being shaped. The challenge is to harmonise the light with its environment. Here, the light fitting serves as a medium. Luminaire families from SCHMITZ are similar to light itself: present and yet subject to change. Their stringent design in various forms and sizes fits in naturally with every architectural style. With varying placement and installation options, they transform light into formative illumination.



Weiter gedacht  
Thinking ahead



### **LEO – Licht emittierende Optik**

Licht ist immateriell, aber real. Die Leuchte PARO greift diesen faszinierenden Wesenszug auf und setzt ihn mit innovativer Lichtleitertechnik gestalterisch um. Die LED-Beleuchtung verbirgt sich im Leuchtenrand. Das Licht strömt im eingeschalteten Zustand durch eine Scheibe und lässt diese leuchten. In ausgeschaltetem Zustand wird die Scheibe wieder nahezu transparent. Die Leuchte wirkt filigran und leicht. So können beispielsweise Arbeitsplätze bedarfsgerecht und optimal von oben beleuchtet werden und behalten eine ansprechende Leichtigkeit.

### **LEO light-emitting optics**

Light is immaterial, but real. The PARO luminaire takes up this fascinating characteristic and incorporates it in its design with innovative light guiding technology. The LED lighting is concealed in the outer edge of the lamp. When switched on, the light flows through a disk, making it glow. When switched off, the disk becomes virtually transparent. The luminaire presents itself in a light, elegant design. It lends itself, for example, to illuminating workplaces optimally and as required from above, giving them an attractive air of comfort.



Dynamisch beleuchten  
Dynamic illumination



### Tunable White

Nicht nur die Helligkeit, sondern vor allem auch die Farbtemperatur einer Leuchte bestimmt die Licht- und Wahrnehmungsqualität. Mit Tunable White eröffnen sich neue Möglichkeiten, wenn es um passgenaue Beleuchtung bei wechselnden Anforderungen geht: Von Warmweiß über Neutral- bis Kaltweiß kann die Farbtemperatur einer Leuchte variabel eingestellt werden. In Verkaufsräumen können so wechselnde Waren, wie z. B. saisonale Produkte, immer optimal beleuchtet werden. In Büro-, Bildungs- und Pflegeeinrichtungen kann mit Hilfe von Tunable White die sich verändernde Qualität des Tageslichts nachgebildet werden. Dies wirkt sich positiv auf die Nutzer bzw. Bewohner aus: Der stufenlose Wechsel von entspannendem Warmweiß bis zu aktivierendem Kaltweiß stabilisiert die biologische Uhr des Menschen und fördert Leistungsfähigkeit und Wohlbefinden.

### Tunable White

The quality of light and its perception is determined not only by the brightness of a lamp, but particularly by its colour temperature. Tunable White opens up new possibilities when it comes to lighting made for changing requirements. The colour temperature of the light can be varied from warm white via neutral to cold white. In showrooms, varying types of merchandise such as seasonal products can always be optimally illuminated. In offices, education centres and care-giving institutions, the changing quality of daylight can be simulated with the help of Tunable White. This has a positive effect on users and residents: the stepless adjustment from relaxing warm white to activating cold white stabilises the human biological clock and enhances both performance and wellbeing.

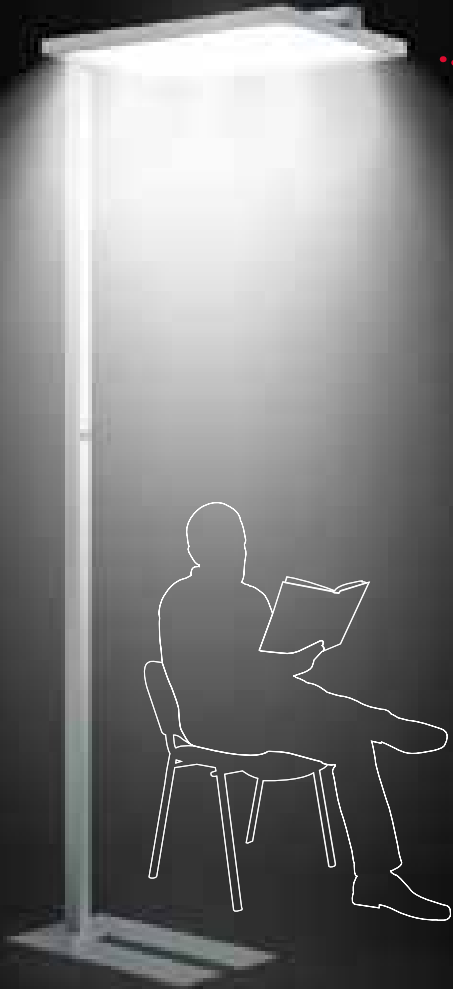
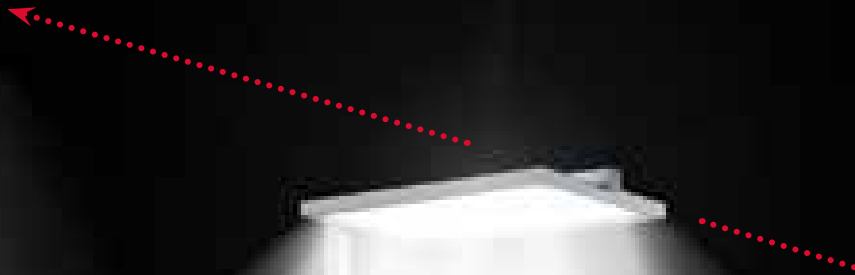

Connect  
Connect



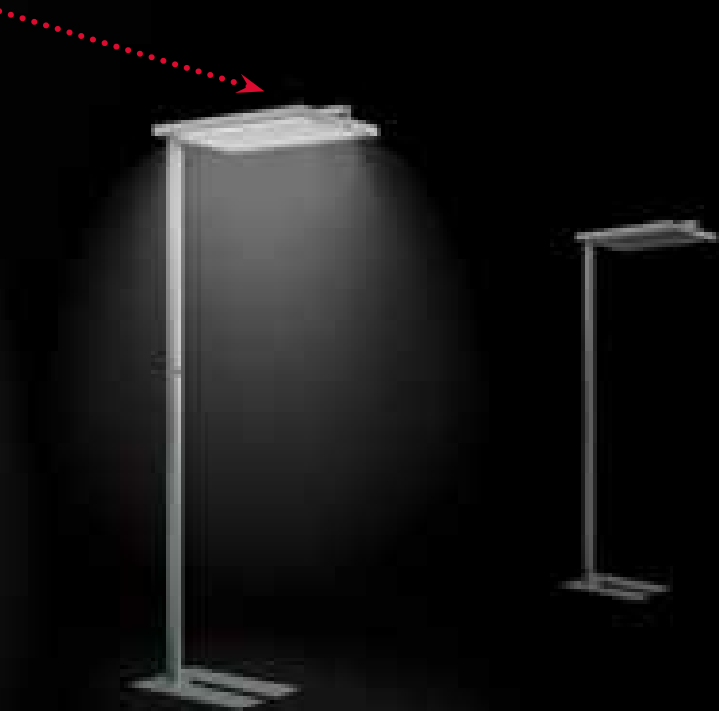

### Intelligente Beleuchtung

Früher galt an oder aus, überall hell oder ringsum dunkel. Mit kommunizierenden Leuchten ergeben sich heute neue Möglichkeiten der Bedienung, Funktion und Energieeffizienz. So lassen sich beispielsweise an dunklen Tagen sowie morgens und abends in großen Büroräumen angenehme Lichtinseln schaffen – ohne energieintensive „Festbeleuchtung“ oder beunruhigende Schatten. Dabei ist das Prinzip ganz einfach: Schmitz CONNECT fasst einzelne PARO oder FACTORY Stehleuchten zu Leuchtengruppen zusammen. Wird eine dieser Leuchten über Tageslicht- und Anwesenheitssensoren oder Funkschalter angeschaltet, gibt sie diese Information an die benachbarten Leuchten weiter. Diese geben dann ebenfalls Licht ab.

### Intelligent lighting

Formerly, it was just on or off, either bright or dark everywhere. Today, new possibilities of operation, functionality and energy efficiency are opened up by luminaires which communicate. For example, pleasant islands of light can be created in large office rooms on dark days or mornings and evenings – without energy-intensive “festive illumination” or ominous shadows. The principle is very simple: Schmitz CONNECT combines individual PARO or FACTORY floor lights into groups of lights. When one of these luminaires is switched on via daylight and presence sensors or radio switch, it passes this information on to the neighbouring luminaires. These then also light up.



Innovativ und optisch filigran – so präsentiert sich die Leuchtenfamilie PARO mit Steh- und Pendelleuchte. Über eine seitliche Lichteinspeisung wird die lichtleitende Scheibe zum Leuchten gebracht. In ausgeschaltetem Zustand ist die Scheibe fast klar – dies sorgt optisch für eine angenehme Leichtigkeit. Die direkte Beleuchtung ist ideal für Bildschirmarbeitsplätze, der indirekte Lichtanteil bewirkt eine zusätzliche Deckenaufhellung. Der Tageslicht- und Anwesenheitssensor spart Energie und macht aus PARO eine effiziente und nachhaltige Lösung für Büros. Mit dem CONNECT-Modul kann die Stehleuchte PARO mit benachbarten Leuchten der gleichen Leuchtengruppe kommunizieren. So entstehen zu jeder Tages- und Jahreszeit angenehme Beleuchtungsszenarien.

Innovative and visually elegant – this is how the PARO luminaire family presents itself with floor lights and pendant models. The disk that lets the light through is lit by laterally mounted lighting. The disk is almost transparent when switched off – which gives it a pleasant appearance of lightness. The direct light is ideal for computer workplaces, and the indirect part of the light provides additional illumination of the ceiling. The daylight and presence sensor saves energy and makes the PARO an efficient and sustainable solution for offices. The CONNECT module enables the PARO floor light to communicate with neighbouring luminaires of the same group. In this way, pleasant lighting scenarios are created at any time of day or season of the year.



PARO





PARO





PARO

# PARO

## Pendelleuchte

- › LEO Lichtleittechnologie für blendfreies Licht im Betrieb und transparente Optik im ausgeschalteten Zustand
- › Für Bildschirmarbeitsplatzbeleuchtung geeignet
- › Wahlweise mit Betriebsgerät im Baldachin oder in Hohldecke mit Abdeckplatte
- › Oberfläche Aluminium eloxiert
- › Ohne sichtbare Schrauben
- › Insektendicht
- › Werkzeuglos verstellbare Stahlseilaufhängung  
L max. 1.500 mm
- › Lichtverteilung direkt/indirekt für zusätzliche Deckenaufhellung



## Pendant light

- › LEO light guiding technology for glare free light when used and transparent appearance when switched off
- › Suitable for computer workstations
- › Driver optionally in white canopy or recessed
- › Surface aluminium anodised
- › Without visible screws
- › Insect-proof
- › Tool-free, adjustable steel cable suspension, L max. 1.500 mm
- › Direct/indirect light distribution for additional ceiling lighting

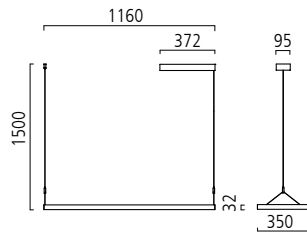

Mit Baldachin weiß  
With canopy white

1.160 x 350 x 32 mm	
3000 K, 84 W, 95 lm/W, Ra>80	6,9 kg
<b>137-002-203</b>	ON/OFF
<b>137-002-223</b>	DIM DALI
4000 K, 84 W, 101 lm/W, Ra>80	6,9 kg
<b>137-002-204</b>	ON/OFF
<b>137-002-224</b>	DIM DALI

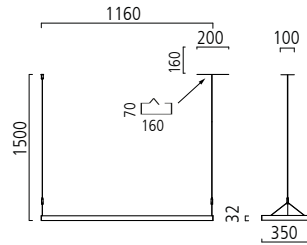

Mit Abdeckplatte weiß  
With mounting plate white

1.160 x 350 x 32 mm	
3000 K, 84 W, 95 lm/W, Ra>80	6,3 kg
<b>137-003-203</b>	ON/OFF
<b>137-003-223</b>	DIM DALI
4000 K, 84 W, 101 lm/W, Ra>80	6,3 kg
<b>137-003-204</b>	ON/OFF
<b>137-003-224</b>	DIM DALI

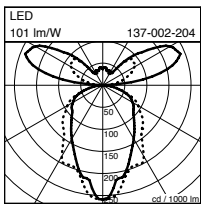



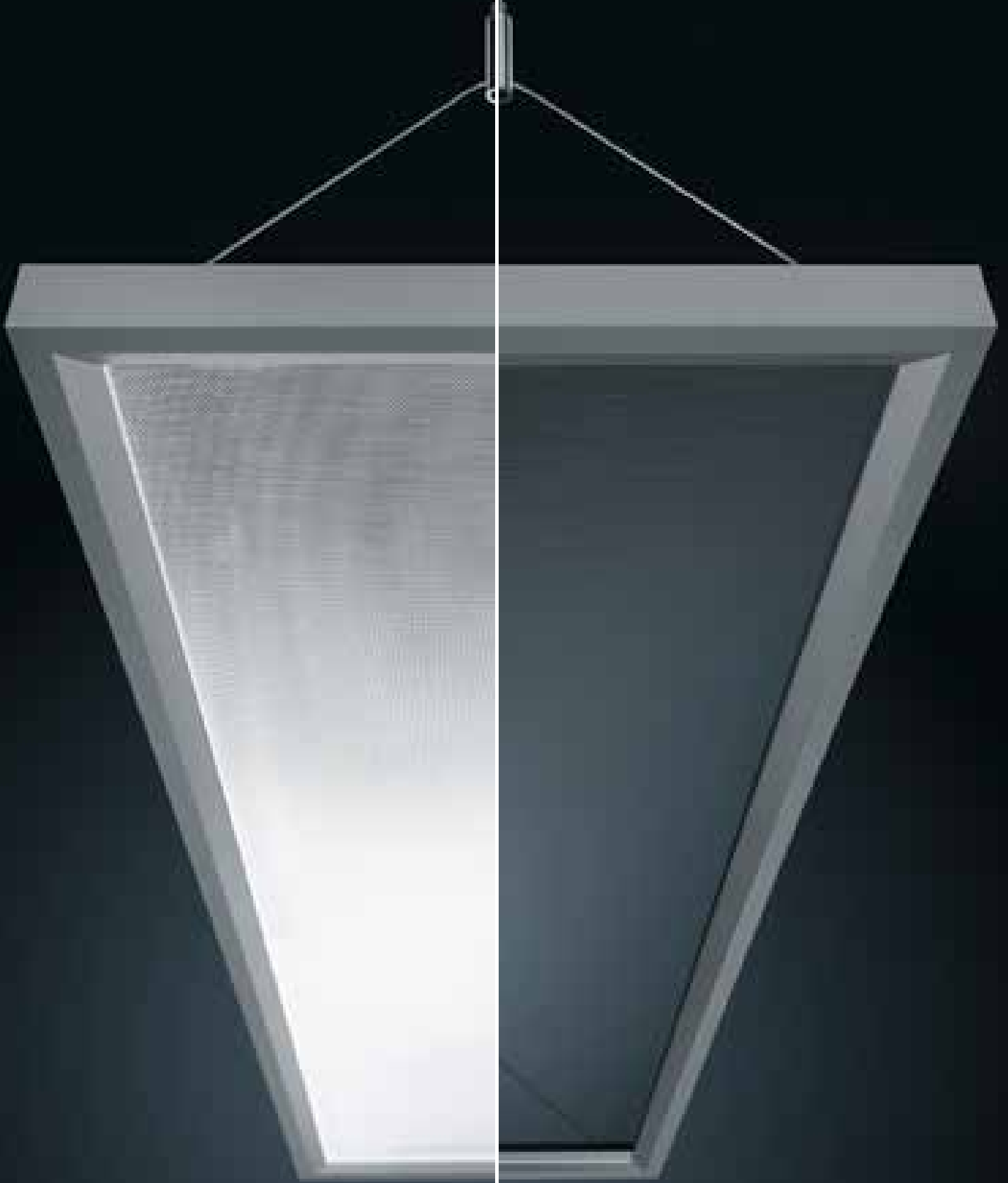

ON OFF

# PARO

## Stehleuchte

- › LEO Lichtleittechnologie für blendfreies Licht im Betrieb und transparente Optik im ausgeschalteten Zustand
- › Für Bildschirmarbeitsplatzbeleuchtung
- › Oberfläche Standrohr und Fuß silbergrau oder weiß
- › Oberfläche Leuchtenkopf Aluminium eloxiert
- › Klare lichtleitende Scheibe
- › Ohne sichtbare Schrauben
- › Insektendicht
- › Lichtverteilung direkt/indirekt für zusätzliche Deckenaufhellung
- › Seitliche Lichteinspeisung mit energieeffizienten Low-Power-LEDs
- › Lieferung 3-teilig



## Floor light

- › Suitable for computer workstations
- › LEO light guiding technology for glare free light while used and transparent appearance when switched off
- › Luminaire body silver grey or white
- › Luminaire head aluminium anodised
- › Without visible screws
- › Insect-proof
- › Direct/indirect light distribution for additional ceiling lighting
- › Lateral light infeed with energy-efficient low-power LEDs
- › Delivery in three parts

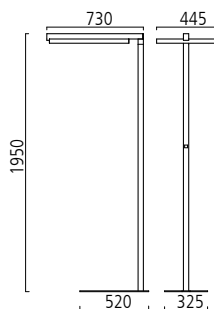

3000 K, 65 W, 81 lm/W, Ra > 80 21,0 kg

- |                    |   |
|--------------------|---|
| <b>137-001-123</b> | DIM<br>weiß / white   |
| <b>137-001-223</b> | DIM<br>silbergrau / silver grey                                 |
| <b>137-001-133</b> | DIM SENSOR <sup>1)</sup><br>weiß / white                        |
| <b>137-001-233</b> | DIM SENSOR <sup>1)</sup><br>silbergrau / silver grey            |
| <b>137-004-133</b> | DIM SENSOR CONNECT <sup>1) 2)</sup><br>weiß / white             |
| <b>137-004-233</b> | DIM SENSOR CONNECT <sup>1) 2)</sup><br>silbergrau / silver grey |

4000 K, 65 W, 86 lm/W, Ra > 80 21,0 kg

- |                    |   |
|--------------------|---|
| <b>137-001-124</b> | DIM<br>weiß / white   |
| <b>137-001-224</b> | DIM<br>silbergrau / silver grey                                 |
| <b>137-001-134</b> | DIM SENSOR <sup>1)</sup><br>weiß / white                        |
| <b>137-001-234</b> | DIM SENSOR <sup>1)</sup><br>silbergrau / silver grey            |
| <b>137-004-134</b> | DIM SENSOR CONNECT <sup>1) 2)</sup><br>weiß / white             |
| <b>137-004-234</b> | DIM SENSOR CONNECT <sup>1) 2)</sup><br>silbergrau / silver grey |

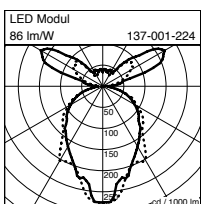

### DIM

Dimmbar / Dimmable

### DIM SENSOR

Dimmbar + Tageslicht- und Anwesenheitssensor  
Dimmable + Daylight and movement sensor

### DIM SENSOR CONNECT

Dimmbar + Tageslicht- und Anwesenheitssensor +  
Verknüpfung einzelner Leuchten per Funk. Gemeinsame  
Steuerung ganzer Leuchtengruppen.  
Dimmable + Daylight and movement sensor + Wireless connection  
of light fixtures. Control of entire groups of luminaires.

## Zubehör / Accessories

<b>137-801-000</b>	1) Reflektorspiegel für erweiterten Erfassungsradius des Anwesenheitssensors Reflector for extended radius of the movement sensor
<b>128-802-000</b>	2) Programmiergerät für CONNECT Leuchten Programming unit for CONNECT luminaires





Trotz ihres beeindruckenden Volumens strahlt ROTONDA eine große Leichtigkeit aus und verleiht Restaurants, Bars oder Hotellobbys eine angenehme Loungeatmosphäre. Als Pendel- oder Deckenleuchte besitzt ROTONDA die Strahlkraft, um elegante Behaglichkeit zu schaffen. Farbige Stoffe harmonieren miteinander. 30 Schirmfarben stehen standardmäßig zur Verfügung. Auch Einzelanfertigungen mit Sonderfarben und anderen Stoffen sind möglich. Bei der individuellen Planung hilft der Online-Konfigurator.

Despite its impressive size, ROTONDA exudes an air of lightness and creates a refined lounge atmosphere in restaurants, bars and hotel lobbies. Whether as a pendant or ceiling light, ROTONDA provides the radiance to create a sense of relaxed elegance. Coloured fabrics harmonise with each other. 30 lamp shade colours are available as standard. Customised versions with special colours and other fabrics can be made to order. The online configurator helps with individual planning.



# ROTONDA





# ROTONDA







# ROTONDA

pure white 401

classic white 402

natural white 403

light beige 404

lemon 405

light pink 406

purple rain 407

fresh pink 408

racing red 409

classic red 410

royal red 411

bordeaux red 412

light blue 413

caribbean blue 414

marina blue 415

royal blue 416

fresh green 417

lime green 418

fresh orange 419

poppy orange 420

elegant beige 421

dark beige 422

sand 423

maron 424

limestone grey 425

café 426

platinum grey 427

urban grey 428

carbon grey 429

pure black 430



# ROTONDA

# ROTONDA LED

## Decken- und Pendelleuchte

- › Deckenleuchten- und Pendelleuchtenarmaturen in 3 Größen
- › Leuchtschirme Chintz in 30 Standardfarben erhältlich
- › Feuerfest (B1) auf Anfrage möglich
- › Lichtverteilung direkt
- › Energieeffiziente Low-Power-LEDs
- › **Leuchtenarmatur und Leuchtschirm bitte separat bestellen**



Deckenleuchtenarmatur für direkte Deckenmontage, weiß (ohne Leuchtschirm)  
Ceiling light fixture for direct installation at ceiling, white (without shade)

LED IP20

## Ceiling and pendant light

- › Ceiling and pendant light fixtures in 3 sizes
- › Shades Chintz available in 30 standard colours
- › Fire resistant (B1) possible on request
- › Direct light distribution
- › Energy-efficient low-power LEDs
- › **Please order fixture and shade separately**

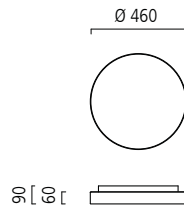

**Ø 460 mm**  
3000 K, 31 W, 90 lm/W, Ra > 80 3,5 kg  
**133-014-103** ON/OFF  
**133-014-123** DIM DALI  
4000 K, 31 W, 98 lm/W, Ra > 80 3,5 kg  
**133-014-104** ON/OFF  
**133-014-124** DIM DALI

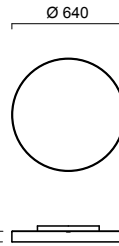

**Ø 640 mm**  
3000 K, 61 W, 95 lm/W, Ra > 80 5,5 kg  
**133-010-103** ON/OFF  
**133-010-123** DIM DALI  
4000 K, 61 W, 103 lm/W, Ra > 80 5,5 kg  
**133-010-104** ON/OFF  
**133-010-124** DIM DALI

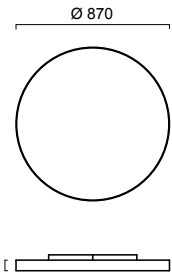

**Ø 870 mm**  
3000 K, 117 W, 92 lm/W, Ra > 80 6,5 kg  
**133-011-103** ON/OFF  
**133-011-123** DIM DALI  
4000 K, 117 W, 100 lm/W, Ra > 80 6,5 kg  
**133-011-104** ON/OFF  
**133-011-124** DIM DALI

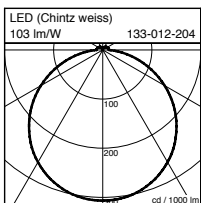
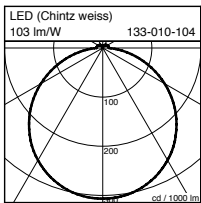

Pendelleuchtenarmatur mit Baldachin und kürzbarer Stahlseilaufhängung, L 3.000 mm, chrom (ohne Leuchtschirm)  
Pendant light fixture with canopy and shortable steel cable suspension L 3.000 mm, chrome (without shade)

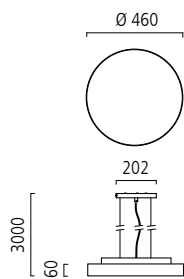

**Ø 460 mm**  
3000 K, 31 W, 90 lm/W, Ra > 80 4,5 kg  
**133-015-203** ON/OFF  
**133-015-223** DIM DALI  
4000 K, 31 W, 98 lm/W, Ra > 80 4,5 kg  
**133-015-204** ON/OFF  
**133-015-224** DIM DALI

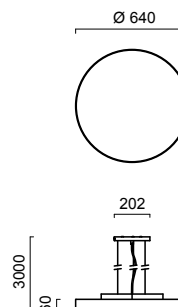

**Ø 640 mm**  
3000 K, 61 W, 95 lm/W, Ra > 80 10 kg  
**133-012-203** ON/OFF  
**133-012-223** DIM DALI  
4000 K, 61 W, 103 lm/W, Ra > 80 10 kg  
**133-012-204** ON/OFF  
**133-012-224** DIM DALI

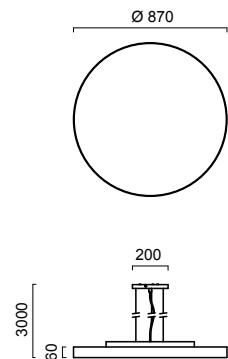

**Ø 870 mm**  
3000 K, 117 W, 92 lm/W, Ra > 80 11 kg  
**133-013-203** ON/OFF  
**133-013-223** DIM DALI  
4000 K, 117 W, 100 lm/W, Ra > 80 11 kg  
**133-013-204** ON/OFF  
**133-013-224** DIM DALI

**Leuchtenarmatur und Leuchtschirm bitte separat bestellen.**  
Please order light fixture and shade separately.

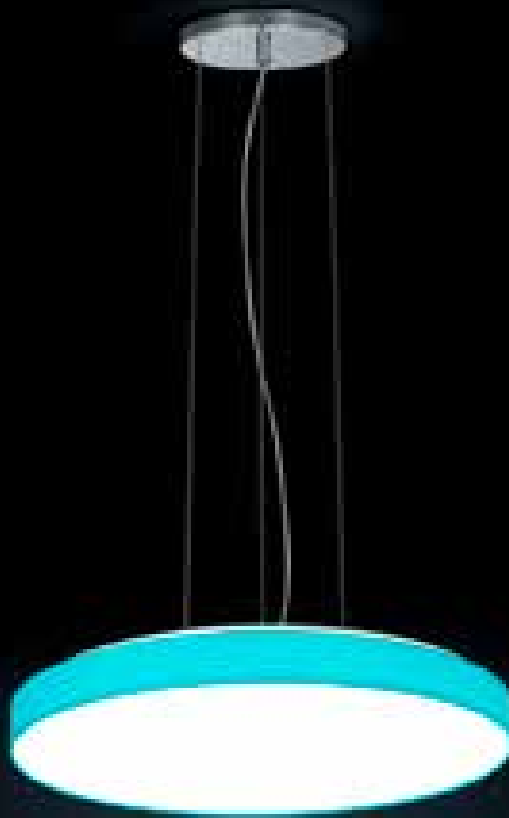

Schirmfarbe / Shade colour: 414 caribbean blue  
 Artikelnummer / item number: 133-101-414



**Leuchtschirme Chintz / lamp shades chintz**

Schirm / shade	Höhe / height 60 mm
Ø 460 mm	133-101-xxx
Ø 640 mm	133-102-xxx
Ø 870 mm	133-103-xxx



**Bestellprinzip für Schirmstoffe**

Bitte ergänzen Sie die Artikelnummer mit dem gewünschten Farbcode für den Schirmstoff der Außenseite (Farbübersicht auf S. 38).  
 Bestellbeispiel: 133-101-414 = Schirmstoff außen in caribbean blue (Farbcode 414) .

Online-Produktkonfigurator auf [www.schmitz-leuchten.de](http://www.schmitz-leuchten.de)

Leuchtenarmatur und Leuchtschirm mit dem gewünschten Schirmstoff individuell konfigurieren und Datenblatt erstellen.

**Ordering Information for Shades**

Please complete the item number with the code for the desired outside shade colour (colours at page 38).

Example: 133-101-414 = shade outside in caribbean blue (colour code 414)

Configuration tool online at [www.schmitz-lighting.com](http://www.schmitz-lighting.com)

Configure your shade colours and light fixtures individually and receive the complete datasheet.

# ROTONDA LED

## Decken- und Pendelleuchte

- › Deckenleuchten- oder Pendelleuchtenarmaturen in 3 Größen
- › Leuchtschirme Chintz in 30 Standardfarben erhältlich
- › Feuerfest (B1) auf Anfrage möglich
- › Lichtverteilung direkt
- › Energieeffiziente Low-Power-LEDs
- › **Leuchtenarmatur und Leuchtschirm bitte separat bestellen**



LED IP20

## Ceiling and pendant light

- › Ceiling or pendant light fixtures in 3 sizes
- › Shades Chintz available in 30 standard colours
- › Fire resistant (B1) available on request
- › Direct light distribution
- › Energy-efficient low-power LEDs
- › **Please order fixture and shade separately**

Deckenleuchtenarmatur für direkte Deckenmontage, weiß (ohne Leuchtschirm)  
Ceiling light fixture for direct installation at ceiling, white (without shade)

Deckenleuchtenarmatur mit Baldachin und Stangenabhängung, chrom (ohne Leuchtschirm)  
Ceiling light fixture with canopy and rod suspension, chrome (without shade)

Pendelleuchtenarmatur mit Baldachin, chrom (ohne Leuchtschirm)  
Pendant light fixture with canopy, chrome (without shade)

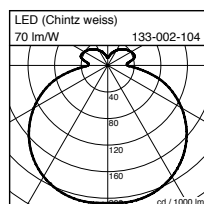

**Ø 650 mm**

3000 K, 35 W, 63 lm/W, Ra > 80	2,9 kg
<b>133-001-103</b>	ON/OFF
<b>133-001-123</b>	DIM DALI
4000 K, 35 W, 66 lm/W, Ra > 80	2,9 kg
<b>133-001-104</b>	ON/OFF
<b>133-001-124</b>	DIM DALI

**Ø 650 mm**

3000 K, 35 W, 63 lm/W, Ra > 80	3,9 kg
<b>133-004-203</b>	ON/OFF
<b>133-004-223</b>	DIM DALI
4000 K, 35 W, 66 lm/W, Ra > 80	3,9 kg
<b>133-004-204</b>	ON/OFF
<b>133-004-224</b>	DIM DALI

**Ø 650 mm**

3000 K, 35 W, 63 lm/W, Ra > 80	3,8 kg
<b>133-007-203</b>	ON/OFF
<b>133-007-223</b>	DIM DALI
4000 K, 35 W, 66 lm/W, Ra > 80	3,8 kg
<b>133-007-204</b>	ON/OFF
<b>133-007-224</b>	DIM DALI

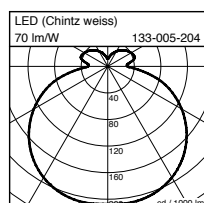

**Ø 780 mm**

3000 K, 50 W, 66 lm/W, Ra > 80	3,9 kg
<b>133-002-103</b>	ON/OFF
<b>133-002-123</b>	DIM DALI
4000 K, 50 W, 70 lm/W, Ra > 80	3,9 kg
<b>133-002-104</b>	ON/OFF
<b>133-002-124</b>	DIM DALI

**Ø 780 mm**

3000 K, 50 W, 66 lm/W, Ra > 80	5 kg
<b>133-005-203</b>	ON/OFF
<b>133-005-223</b>	DIM DALI
4000 K, 50 W, 70 lm/W, Ra > 80	5 kg
<b>133-005-204</b>	ON/OFF
<b>133-005-224</b>	DIM DALI

**Ø 780 mm**

3000 K, 50 W, 66 lm/W, Ra > 80	4,9 kg
<b>133-008-203</b>	ON/OFF
<b>133-008-223</b>	DIM DALI
4000 K, 50 W, 70 lm/W, Ra > 80	4,9 kg
<b>133-008-204</b>	ON/OFF
<b>133-008-224</b>	DIM DALI

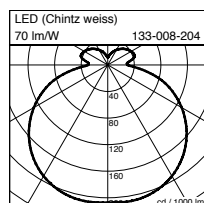

**Ø 1.000 mm**

3000 K, 65 W, 68 lm/W, Ra > 80	5,2 kg
<b>133-003-103</b>	ON/OFF
<b>133-003-123</b>	DIM DALI
4000 K, 65 W, 71 lm/W, Ra > 80	5,2 kg
<b>133-003-104</b>	ON/OFF
<b>133-003-124</b>	DIM DALI

**Ø 1.000 mm**

3000 K, 65 W, 68 lm/W, Ra > 80	6,5 kg
<b>133-006-203</b>	ON/OFF
<b>133-006-223</b>	DIM DALI
4000 K, 65 W, 71 lm/W, Ra > 80	6,5 kg
<b>133-006-204</b>	ON/OFF
<b>133-006-224</b>	DIM DALI

**Ø 1.000 mm**

3000 K, 65 W, 68 lm/W, Ra > 80	6,2 kg
<b>133-009-203</b>	ON/OFF
<b>133-009-223</b>	DIM DALI
4000 K, 65 W, 71 lm/W, Ra > 80	6,2 kg
<b>133-009-204</b>	ON/OFF
<b>133-009-224</b>	DIM DALI



Deckenleuchte mit Leuchtschirm, Höhe 200 mm, außen „pure black“ (430) und innen „racing red“ (409) = 133-107-430-409  
 Ceiling light with shade height 200 mm, outside „pure black“ (430) and inside „racing red“ (409) = 133-107-430-409



Leuchtschirme Chintz / lamp shades	Höhe / height 115 mm	Höhe / height 200 mm
Ø 650 mm	133-104-xxx-xxx	133-107-xxx-xxx
Ø 780 mm	133-105-xxx-xxx	133-108-xxx-xxx
Ø 1.000 mm	133-106-xxx-xxx	133-109-xxx-xxx

#### Bestellprinzip für Schirmstoffe

Bitte ergänzen Sie die Artikelnummer mit den gewünschten Farbcodes für die Schirmstoffe außen und innen (Farbübersicht auf S. 38).  
 Bestellbeispiel: 133-107-430-409 = Schirmstoff außen in pure black (Farbcode 430), Schirmstoff innen in racing red (Farbcode 409)

Online-Produktkonfigurator auf [www.schmitz-leuchten.de](http://www.schmitz-leuchten.de)

Leuchtenarmatur und Leuchtschirm mit dem gewünschten Schirmstoff individuell konfigurieren und Datenblatt erstellen.

#### Ordering Information for Shades

Please complete the item number with the code for the desired shade colour outside and inside (colours at page 38).

Example: 133-107-430-409 = outside shade in pure black (colour code 430), inside shade in racing red (colour code 409)

Configuration tool online at [www.schmitz-lighting.com](http://www.schmitz-lighting.com)

Configure your shade colours and light fixtures individually and receive the complete datasheet.



Elegante Leichtigkeit: Das extrem flache Design von nur 11 mm wird durch seitliche Lichteinspeisung in die opale Scheibe möglich. Das zentrale Quadrat aus Edelstahl rückt den Fokus auf das Wesentliche. Als Wand-, Decken- und Pendelleuchte wird CALVIA zum eigenständigen Gestaltungselement im Objektbereich. Die Lichtabstrahlung nach hinten beleuchtet indirekt Decke oder Wand und setzt zusätzliche Akzente.

Elegant lightness: the extremely flat design that is only 11 mm thick is made possible by edge lighting at the sides of the opal disk. The central rectangle of stainless steel draws the focus of attention to what really matters. The CALVIA becomes a design element of its own within public areas when used either as a wall, ceiling or pendant light. The emission of the light to the rear indirectly lights up the ceiling or wall and sets additional styling accents.



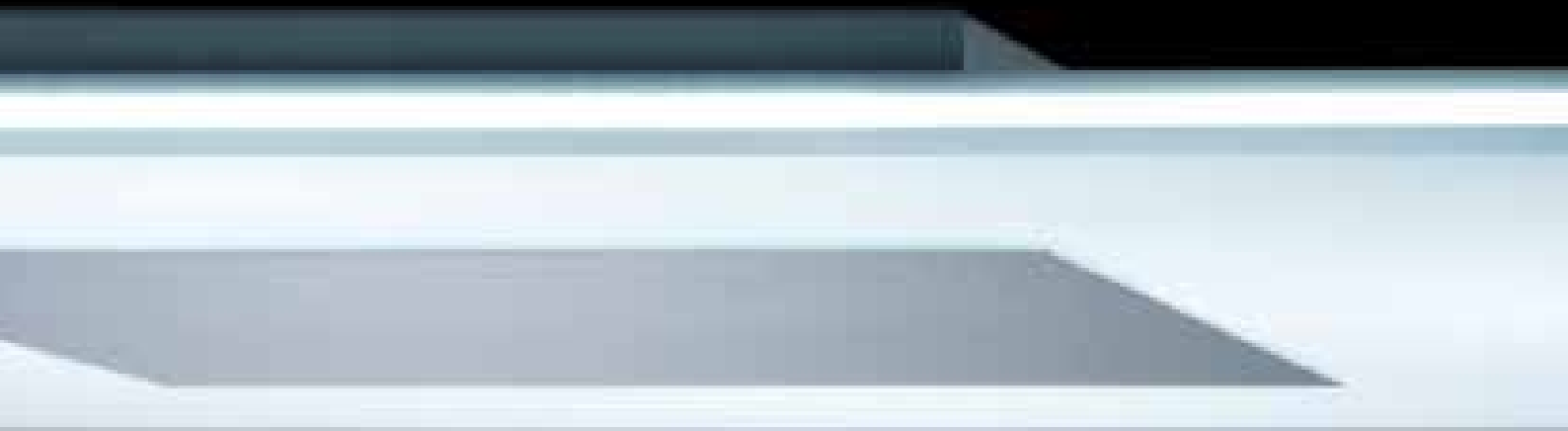

CALVIA





CALVIA

# CALVIA

## Wand- und Pendelleuchte

- › Ultraflach – nur 11 mm
- › Oberfläche Edelstahl
- › Opale lichtleitende Glasscheibe
- › Ohne sichtbare Schrauben
- › Insektendicht
- › Lichtverteilung direkt/indirekt für zusätzliche Akzentuierung an der Wand/Decke
- › Seitliche Lichteinspeisung mit energieeffizienten Low-Power- LEDs

## Pendelleuchte

- › Werkzeuglos höhenverstellbare Stahlseilaufhängung, L. max. 2.000 mm



## Wall and pendant light

- › Ultra-flat – only 11 mm
- › Surface stainless steel
- › Opal, light-conducting glass pane
- › Without visible screws
- › Insect-proof
- › Direct/indirect light distribution for additional accentuation on wall/ceiling
- › Lateral light infeed with energy-efficient low-power LEDs

## Pendant light

- › Tool-free, height-adjustable steel cable suspension, L. max. 2.000 mm



Design: S & R. Cornelissen



Design: S & R. Cornelissen

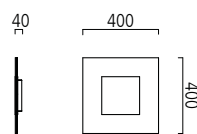

400 x 400 mm			
3000K, 34 W, 68 lm/W, Ra > 80			4,25 kg
<b>131-001-203</b>	ON/OFF		
<b>131-001-223</b>	DIM DALI		
4000K, 34 W, 71 lm/W, Ra > 80			4,25 kg
<b>131-001-204</b>	ON/OFF		
<b>131-001-224</b>	DIM DALI		

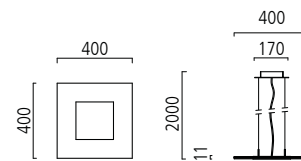

400 x 400 mm			
3000K, 34 W, 68 lm/W, Ra > 80			5,3 kg
<b>131-003-203</b>	ON/OFF		
<b>131-003-223</b>	DIM DALI		
4000K, 34 W, 71 lm/W, Ra > 80			5,3 kg
<b>131-003-204</b>	ON/OFF		
<b>131-003-224</b>	DIM DALI		

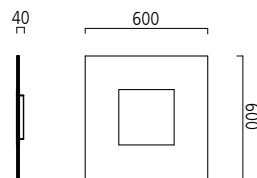

600 x 600 mm			
3000K, 55 W, 65 lm/W, Ra > 80			9,1 kg
<b>131-002-203</b>	ON/OFF		
<b>131-002-223</b>	DIM DALI		
4000K, 55 W, 68 lm/W, Ra > 80			9,1 kg
<b>131-002-204</b>	ON/OFF		
<b>131-002-224</b>	DIM DALI		

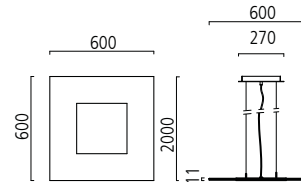

600 x 600 mm			
3000K, 55 W, 65 lm/W, Ra > 80			10,8 kg
<b>131-004-203</b>	ON/OFF		
<b>131-004-223</b>	DIM DALI		
4000K, 55 W, 68 lm/W, Ra > 80			10,8 kg
<b>131-004-204</b>	ON/OFF		
<b>131-004-224</b>	DIM DALI		

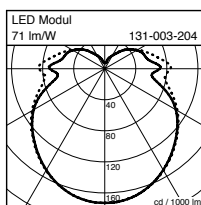
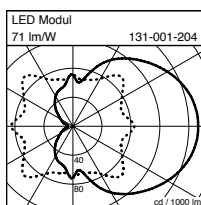





Ein schmales eloxiertes Aluminiumband fasst den von Wand oder Decke abgesetzten Leuchtenkörper – die opale Abdeckung geht darüber hinaus und bringt so einen zusätzlichen Lichtanteil zur Seite. Rund, eckig oder mit abgerundeten Ecken und in verschiedenen Größen bietet CORUM als breite Produktfamilie vielfältige Einsatzmöglichkeiten. Und die Option, die gesamte Architektur mit einem durchgängigen Leuchtenkonzept zu gestalten.

A narrow anodised aluminium strip surrounds the main body of the luminaire to set it off from the wall or ceiling – the opal covering protrudes over it and brings out extra light to the side. Round, square or with soft corners and in various sizes, the wide CORUM family offers a great variety of options for use. And the possibility to design the entire architecture with a consistent lighting concept throughout.



CORUM







# CORUM

# CORUM

## Wand- und Deckenleuchte

- › Abgesetzter Leuchtenkörper
- › Sehr flach – nur 43 mm
- › Oberfläche Aluminium eloxiert
- › Abdeckung opal satiniert für homogene Ausleuchtung
- › Ohne sichtbare Schrauben
- › Insektendicht
- › Werkzeuglose Leuchtenkörpermontage
- › Lichtverteilung direkt/indirekt für zusätzliche Akzentuierung an der Wand/Decke
- › Energieeffiziente Low-Power-LEDs
- ›  XXX-E01 = Leuchte mit Notlicht (Batterie 3h), weitere Notlichtvarianten auf Anfrage möglich



## Wall and ceiling light

- › Detached housing
- › Extremely flat – only 43 mm
- › Surface aluminium anodised
- › Cover opal satinised for uniform illumination
- › Without visible screws
- › Insect-proof
- › Tool-free installation of housing
- › Direct/indirect light distribution for additional accentuation on wall/ceiling
- › Energy-efficient low-power LEDs
- ›  XXX-E01 = lamp with emergency light (battery 3H), other emergency light variants available on request

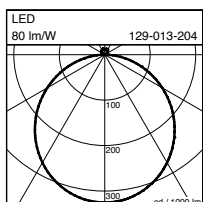
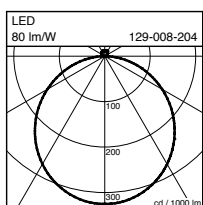
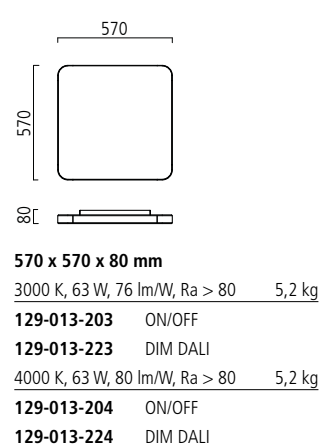
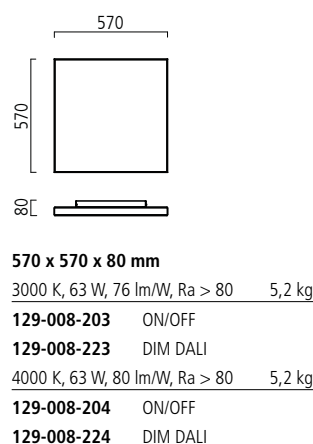
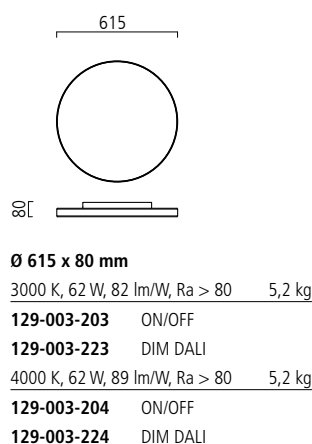
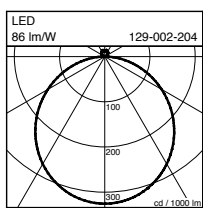
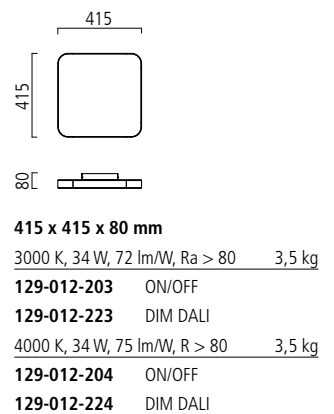
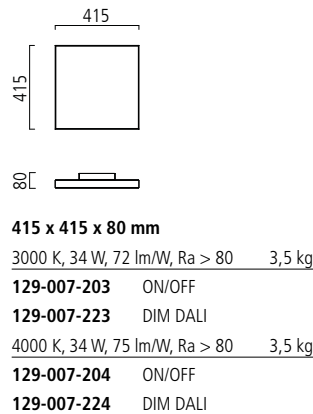
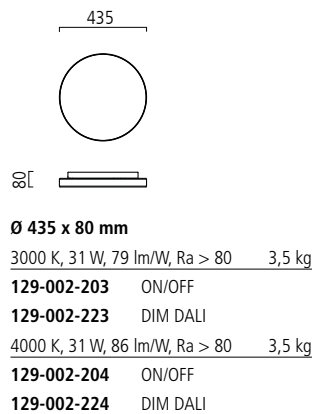
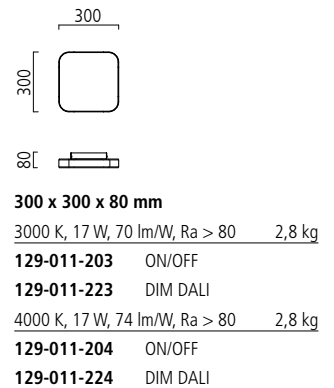
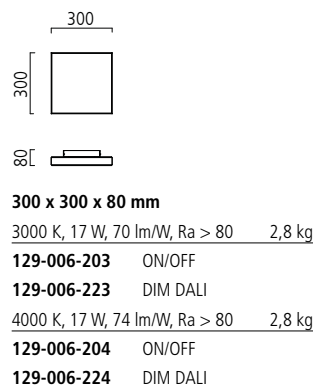
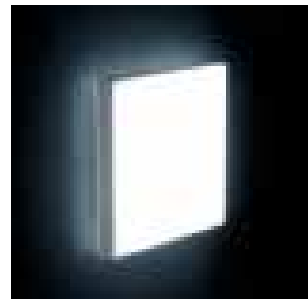
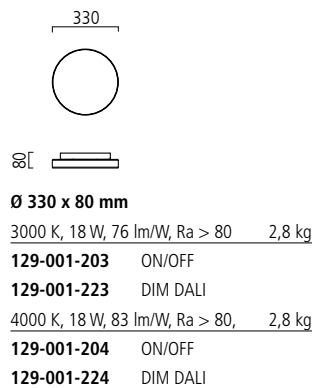



# CORUM

## Pendelleuchte

- › Leuchtenkörper sehr flach – nur 43 mm
- › Oberfläche Aluminium eloxiert
- › Abdeckung opal satiniert für homogene Ausleuchtung
- › Ohne sichtbare Schrauben
- › Insektendicht
- › Werkzeuglos höhenverstellbare Stahlseilaufhängung, L 3.000 mm
- › Werkzeuglose Leuchtenkörpermontage
- › Lichtverteilung direkt/indirekt für zusätzliche Akzentuierung an der Decke
- › Energieeffiziente Low-Power-LEDs
- ›  Notlichtvarianten auf Anfrage möglich



## Pendant light

- › Extremely flat housing – only 43 mm
- › Surface aluminium anodised
- › Cover opal satinised for uniform illumination
- › Without visible screws
- › Insect-proof
- › Tool-free, height-adjustable steel cable suspension, L 3.000 mm
- › Tool-free installation of housing
- › Direct/indirect light distribution for additional accentuation on ceiling
- › Energy-efficient low-power LEDs
- ›  Emergency light variants available on request

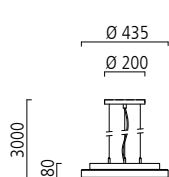

<b>Ø 435 x 80 mm</b>	
3000 K, 31 W, 79 lm/W, Ra > 80	3,0 kg
<b>129-004-203</b>	ON/OFF
<b>129-004-223</b>	DIM DALI
4000 K, 31 W, 86 lm/W, Ra > 80	3,0 kg
<b>129-004-204</b>	ON/OFF
<b>129-004-224</b>	DIM DALI

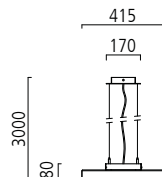

<b>415 x 415 x 80 mm</b>	
3000 K, 34 W, 72 lm/W, Ra > 80	3,0 kg
<b>129-009-203</b>	ON/OFF
<b>129-009-223</b>	DIM DALI
4000 K, 34 W, 75 lm/W, Ra > 80	3,0 kg
<b>129-009-204</b>	ON/OFF
<b>129-009-224</b>	DIM DALI

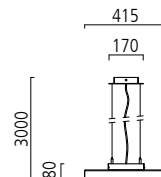

<b>415 x 415 x 80 mm</b>	
3000 K, 34 W, 72 lm/W, Ra > 80	3,0 kg
<b>129-014-203</b>	ON/OFF
<b>129-014-223</b>	DIM DALI
4000 K, 34 W, 75 lm/W, R > 80	3,0 kg
<b>129-014-204</b>	ON/OFF
<b>129-014-224</b>	DIM DALI

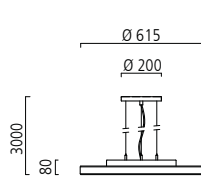

<b>Ø 615 x 80 mm</b>	
3000 K, 62 W, 82 lm/W, Ra > 80	5,4 kg
<b>129-005-203</b>	ON/OFF
<b>129-005-223</b>	DIM DALI
4000 K, 62 W, 89 lm/W, Ra > 80	5,4 kg
<b>129-005-204</b>	ON/OFF
<b>129-005-224</b>	DIM DALI

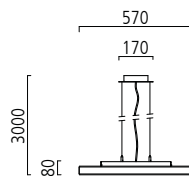

<b>570 x 570 x 80 mm</b>	
3000 K, 63 W, 76 lm/W, Ra > 80	5,4 kg
<b>129-010-203</b>	ON/OFF
<b>129-010-223</b>	DIM DALI
4000 K, 63 W, 80 lm/W, Ra > 80	5,4 kg
<b>129-010-204</b>	ON/OFF
<b>129-010-224</b>	DIM DALI

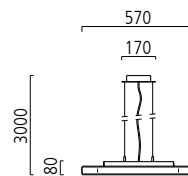

<b>570 x 570 x 80 mm</b>	
3000 K, 63 W, 76 lm/W, Ra > 80	5,4 kg
<b>129-015-203</b>	ON/OFF
<b>129-015-223</b>	DIM DALI
4000 K, 63 W, 80 lm/W, Ra > 80	5,4 kg
<b>129-015-204</b>	ON/OFF
<b>129-015-224</b>	DIM DALI

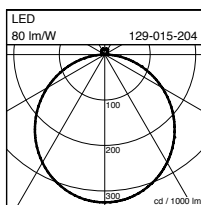
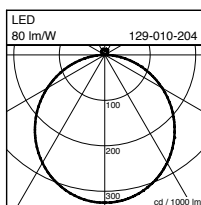
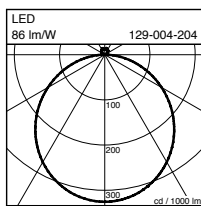



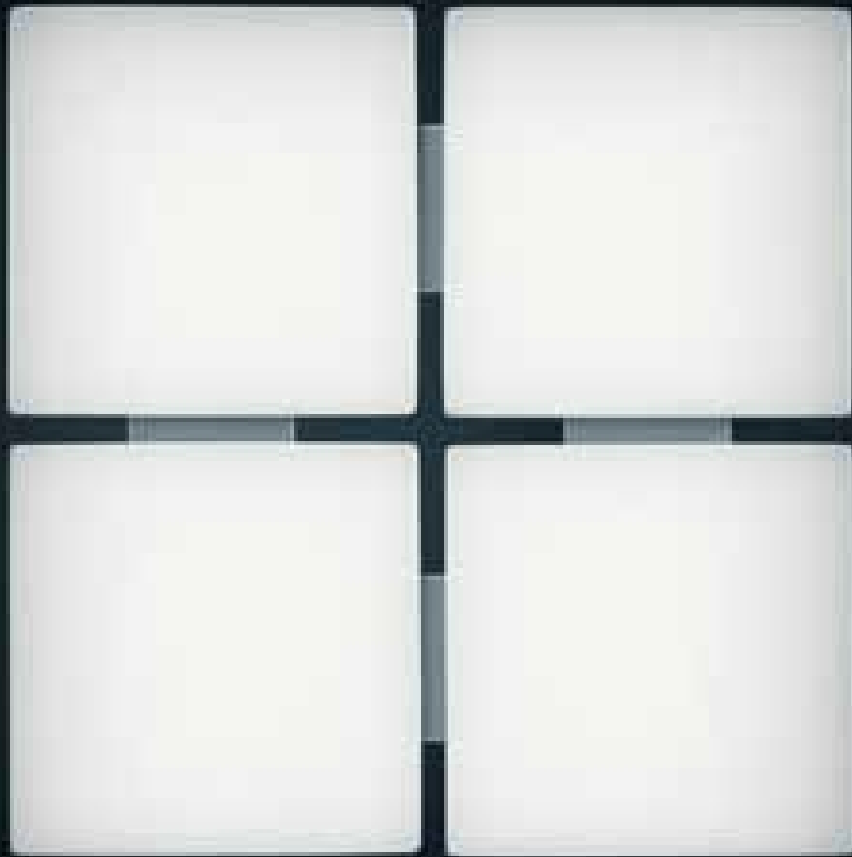

Großflächig komponiert in besonderen Raumsituationen oder als Einzelleuchte funktioniert QUATTRA als flexibles Gestaltungselement in der Architektur. Ein extrem flacher Aufbau lässt eine angenehme Distanz zwischen Leuchtenkörper und Wand oder Decke. Die Module bestehen aus einer, zwei, drei oder vier quadratischen Lichtkacheln, die durch die opal satinierte Abdeckung homogen leuchten.

Whether spread out over large areas in special room situations or as an individual luminaire, the QUATTRA functions as a flexible design element within the architecture. An extremely flat structure allows a pleasant distance between the luminaire and the wall or ceiling. The modules consist of one, two, three or four rectangular light tiles which are evenly lit due to the satin finish opal cover.



QUATTRO







QUATTRO

# QUATTRA

## Wand- und Deckenleuchte

- › Abgesetzter Leuchtenkörper
- › Sehr flach – nur 32 mm
- › Oberfläche silbergrau
- › Abdeckung opal satiniert für homogene Ausleuchtung
- › Ohne sichtbare Schrauben
- › Werkzeuglose Leuchtenkörpermontage
- › Insectendicht
- › Energieeffiziente Low-Power-LEDs
- ›  XXX-E01 = Leuchte mit Notlicht (Batterie 3 h), weitere Notlichtvarianten auf Anfrage möglich



## Wall and ceiling light

- › Detached housing
- › Extremely flat – only 32 mm
- › Surface silver grey
- › Cover opal satinised for uniform illumination
- › Without visible screws
- › Tool-free installation of housing
- › Insect-proof
- › Energy-efficient low-power LEDs
- ›  XXX-E01 = lamp with emergency light (battery 3H), other emergency light variants available on request

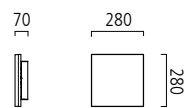
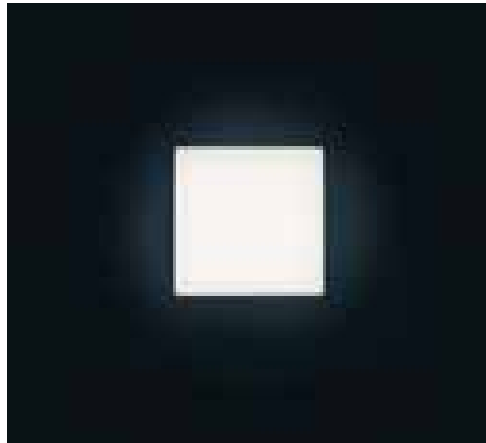
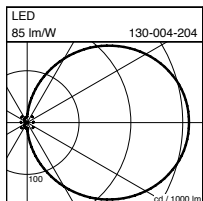

280 x 280 mm		
3000 K, 17 W, 78 lm/W, Ra > 80		2,0 kg
<b>130-001-203</b>	ON/OFF	
<b>130-001-223</b>	DIM DALI	
4000 K, 17 W, 82 lm/W, Ra > 80		2,0 kg
<b>130-001-204</b>	ON/OFF	
<b>130-001-224</b>	DIM DALI	

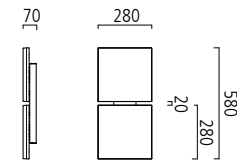

280 x 580 mm		
3000 K, 34 W, 78 lm/W, Ra > 80		4,0 kg
<b>130-002-203</b>	ON/OFF	
<b>130-002-223</b>	DIM DALI	
4000 K, 34 W, 82 lm/W, Ra > 80		4,0 kg
<b>130-002-204</b>	ON/OFF	
<b>130-002-224</b>	DIM DALI	

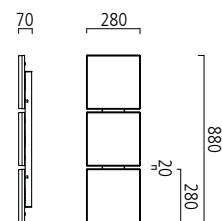

280 x 880 mm		
3000 K, 51 W, 78 lm/W, Ra > 80		6,0 kg
<b>130-003-203</b>	ON/OFF	
<b>130-003-223</b>	DIM DALI	
4000 K, 51 W, 82 lm/W, Ra > 80		6,0 kg
<b>130-003-204</b>	ON/OFF	
<b>130-003-224</b>	DIM DALI	

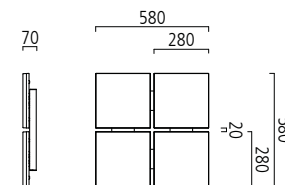

580 x 580 mm		
3000 K, 66 W, 81 lm/W, Ra > 80		8,0 kg
<b>130-004-203</b>	ON/OFF	
<b>130-004-223</b>	DIM DALI	
4000 K, 66 W, 85 lm/W, Ra > 80		8,0 kg
<b>130-004-204</b>	ON/OFF	
<b>130-004-224</b>	DIM DALI	





Unser Klassiker: Die umfangreiche Leuchtenfamilie mit unterschiedlichen Formen, Größen und Bestückungen fügt sich ganz selbstverständlich in verschiedene Umgebungen ein. Die formale Reduktion und dezente Materialität aus eloxiertem Aluminium und weißem Acryl machen aus CLEAR ein vollkommenes Gestaltungselement. Ausgestattet mit neuester Lichttechnologie, weitere Zusatzfunktionen wählbar.

Our classic: the comprehensive luminaire family with various shapes, sizes and forms of mounting fits into all kinds of surroundings as a matter of course. The purist reduction of the shape and the use of high-quality anodised aluminium and white acrylic turn the CLEAR into a complete design element. Making use of the very latest lighting technology, further additional functions are available.

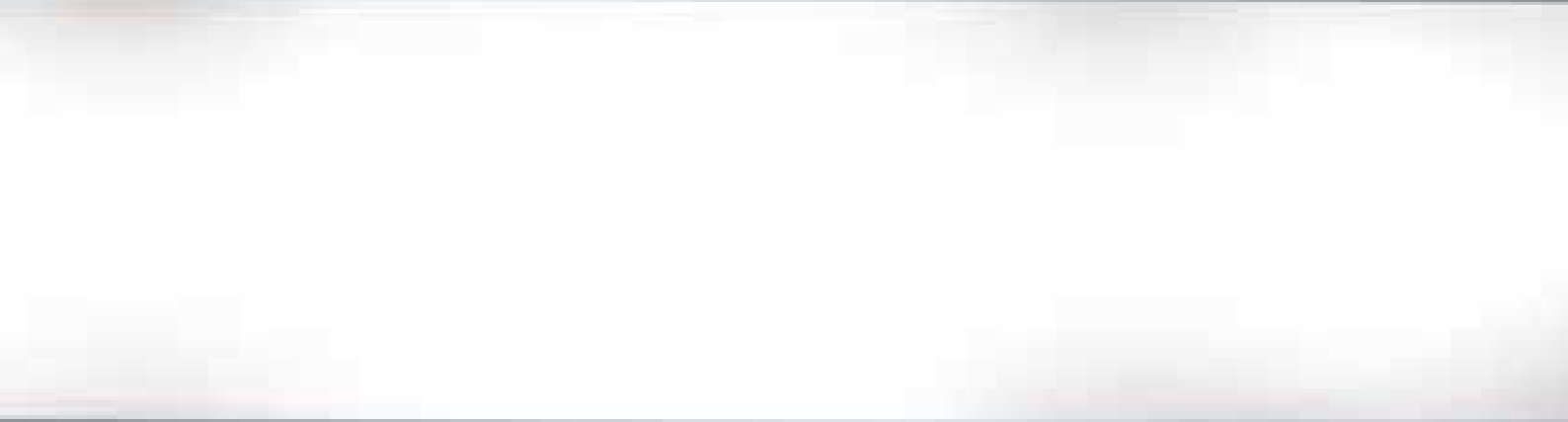

CLEAR





CLEAR

# CLEAR LED

## Wand- und Deckenleuchte

- › Abgesetzter Leuchtenkörper
- › Oberfläche Aluminium eloxiert
- › Abdeckung opal für homogene Ausleuchtung
- › Lichtverteilung direkt/indirekt für zusätzliche Akzentuierung an der Wand/Decke
- › Energieeffiziente Low-Power-LEDs
- ›  XXX-E01 = Leuchte mit Notlicht (Batterie 3h), weitere Notlichtvarianten auf Anfrage möglich



LED IP20

## Wall and ceiling light

- › Detached housing
- › Surface aluminium anodised
- › Cover opal for uniform illumination
- › Direct/indirect light distribution for additional accentuation on wall/ceiling
- › Energy-efficient low-power LEDs
- ›  XXX-E01 = lamp with emergency light (battery 3H), other emergency light variants available on request

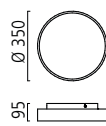

**Ø 350 x 95 mm**

3000 K, 18 W, 74 lm/W, Ra > 80	3,0 kg
<b>121-005-203</b>	ON/OFF
<b>121-005-223</b>	DIM DALI
4000 K, 18 W, 80 lm/W, Ra > 80	3,0 kg
<b>121-005-204</b>	ON/OFF
<b>121-005-224</b>	DIM DALI

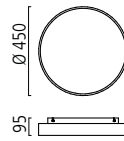

**Ø 450 x 95 mm**

3000 K, 31 W, 76 lm/W, Ra > 80	5,2 kg
<b>121-001-203</b>	ON/OFF
<b>121-001-223</b>	DIM DALI
4000 K, 31 W, 83 lm/W, Ra > 80	5,2 kg
<b>121-001-204</b>	ON/OFF
<b>121-001-224</b>	DIM DALI

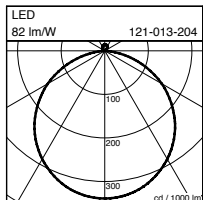

3000 K, 46 W, 78 lm/W, Ra > 80	5,2 kg
--------------------------------	--------

<b>121-013-203</b>	ON/OFF
<b>121-013-223</b>	DIM DALI
4000 K, 46 W, 82 lm/W, Ra > 80	5,2 kg
<b>121-013-204</b>	ON/OFF
<b>121-013-224</b>	DIM DALI

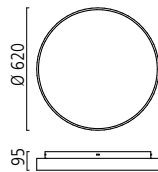

**Ø 620 x 95 mm**

3000 K, 62 W, 79 lm/W, Ra > 80	14,0 kg
<b>121-002-203</b>	ON/OFF
<b>121-002-223</b>	DIM DALI
4000 K, 62 W, 86 lm/W, Ra > 80	14,0 kg
<b>121-002-204</b>	ON/OFF
<b>121-002-224</b>	DIM DALI

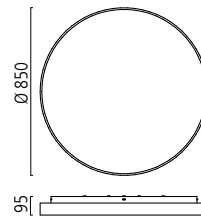

**Ø 850 x 95 mm**

3000 K, 117 W, 77 lm/W, Ra > 80	19,8 kg
<b>121-003-203</b>	ON/OFF
<b>121-003-223</b>	DIM DALI
4000 K, 117 W, 84 lm/W, Ra > 80	19,8 kg
<b>121-003-204</b>	ON/OFF
<b>121-003-224</b>	DIM DALI





# CLEAR

## Wand- und Deckenleuchte

- › Abgesetzter runder Leuchtenkörper
- › Abdeckung opal für homogene Ausleuchtung
- › Lichtverteilung direkt/indirekt für zusätzliche Akzentuierung an der Wand/Decke
- › Notbeleuchtung auf Anfrage



## Wall and ceiling light

- › Detached housing
- › Cover opal for uniform illumination
- › Direct/indirect light distribution for additional accentuation on wall/ceiling
- › Emergency lighting on request

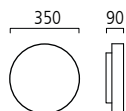
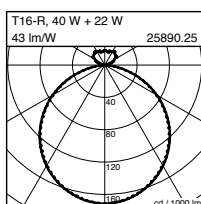

### Ø 350 x 90 mm

1 x TC-F, 18/24 W, 2G10 3,0 kg

- 15890.25** ON/OFF
- 15890.251** DIM 1-10V
- 15890.252** DIM DALI

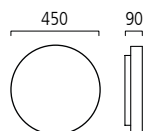

### Ø 450 x 90 mm

1 x T16-R, 22 W, 2GX13 +  
1 x T16-R, 40 W, 2GX13 5,2 kg

- 25890.25** ON/OFF
- 25890.251** DIM 1-10V
- 25890.252** DIM DALI

1 x T16-R, 22 W, 2GX13 2,9 kg

- 15891.25** ON/OFF
- 15891.251** DIM 1-10V
- 15891.252** DIM DALI

2 x TC-F, 24 W, 2G10 5,2 kg

- 25891.25** ON/OFF
- 25891.251** DIM 1-10V
- 25891.252** DIM DALI

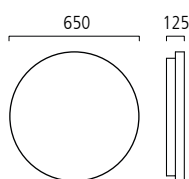

### Ø 650 x 125 mm

6 x TC-L, 18 W, 2G11 14,0 kg

- 65889.25** ON/OFF
- 65889.251** DIM 1-10V
- 65889.252** DIM DALI

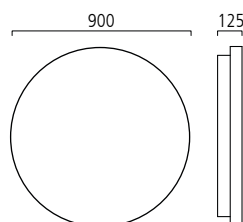

### Ø 900 x 125 mm

8 x TC-L, 18/24 W, 2G11 27,0 kg

- 85889.25** ON/OFF
- 85889.251** DIM 1-10V
- 85889.252** DIM DALI

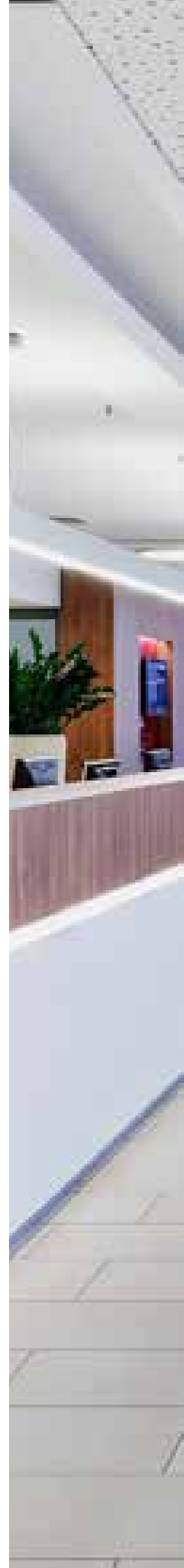



# CLEAR 2 LED / CLEAR 2

## Wand- und Deckenleuchte

- › Oberfläche Aluminium eloxiert
- › Abdeckung opal für homogene Ausleuchtung
- › Ohne sichtbare Schrauben
- › Lichtverteilung direkt
- › Energieeffiziente Low-Power-LEDs oder Leuchtstofflampen
- ›  XXX-E01 = LED Leuchte mit Notlicht (Batterie 3h), weitere Notlichtvarianten auf Anfrage möglich



## Wall and ceiling light

- › Surface aluminium anodised
- › Cover opal for uniform illumination
- › Without visible screws
- › Direct light distribution
- › Energy-efficient low-power LEDs or fluorescent lights
- ›  XXX-E01 = LED lamp with emergency light (battery 3H), other emergency light variants available on request

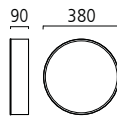
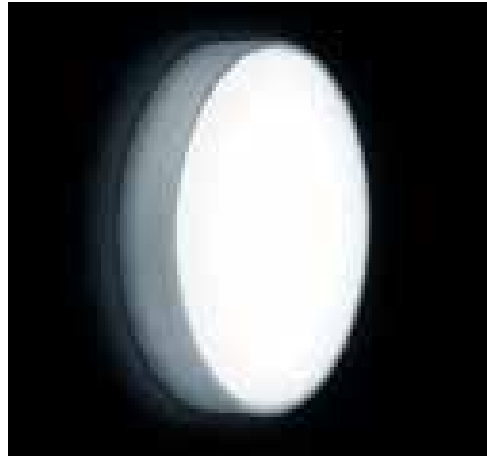

**Ø 380 x 90 mm**

3000 K, 18 W, 70 lm/W, Ra > 80	3,8 kg
<b>121-009-203</b>	ON/OFF
<b>121-009-223</b>	DIM DALI
4000 K, 18 W, 76 lm/W, Ra > 80	3,8 kg
<b>121-009-204</b>	ON/OFF
<b>121-009-224</b>	DIM DALI

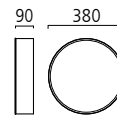

**Ø 380 x 90 mm**

1 x T16-R, 22 W, 2GX13 +	
1 x T16-R, 40 W, 2GX13	3,8 kg
<b>25267.25</b>	ON/OFF
<b>25267.251</b>	DIM 1-10V
<b>25267.252</b>	DIM DALI

2 x TC-F, 24 W, 2G10	4,0 kg
<b>25269.25</b>	ON/OFF
<b>25269.251</b>	DIM 1-10V
<b>25269.252</b>	DIM DALI

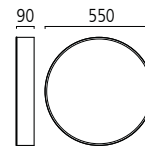

**Ø 550 x 90 mm**

6 x TC-L, 18 W, 2G11	6,4 kg
<b>65283.25</b>	ON/OFF
<b>65283.251</b>	DIM 1-10V
<b>65283.252</b>	DIM DALI

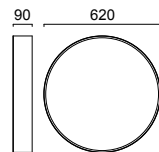
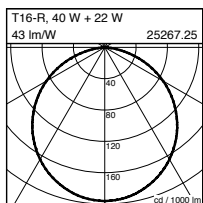
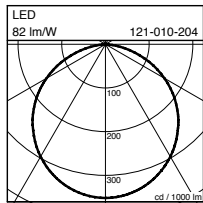

**Ø 620 x 90 mm**

3000 K, 62 W, 75 lm/W, Ra > 80	6,4 kg
<b>121-010-203</b>	ON/OFF
<b>121-010-223</b>	DIM DALI
4000 K, 62 W, 82 lm/W, Ra > 80	6,4 kg
<b>121-010-204</b>	ON/OFF
<b>121-010-224</b>	DIM DALI

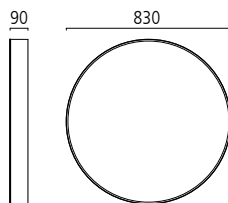

**Ø 830 x 90 mm**

3000 K, 117 W, 74 lm/W, Ra > 80	14,8 kg
<b>121-012-203</b>	ON/OFF
<b>121-012-223</b>	DIM DALI
4000 K, 117 W, 80 lm/W, Ra > 80	14,8 kg
<b>121-012-204</b>	ON/OFF
<b>121-012-224</b>	DIM DALI

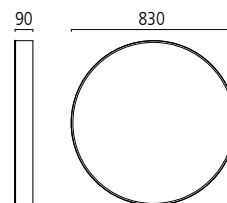

**Ø 830 x 90 mm**

8 x TC-L, 18/24 W, 2G11	9,2 kg
<b>85284.25</b>	ON/OFF
<b>85284.251</b>	DIM 1-10V
<b>85284.252</b>	DIM DALI



# CLEAR LED

## Pendelleuchte

- › Oberfläche Aluminium eloxiert
- › Abdeckung opal für homogene Ausleuchtung
- › Werkzeuglos höhenverstellbare Stahlseilaufhängung, L 3.000 mm
- › Lichtverteilung direkt/indirekt für zusätzliche Akzentuierung an der Decke
- › Energieeffiziente Low-Power-LEDs oder Leuchtstofflampen
- › XXX-E01 = LED Leuchte mit Notlicht (Batterie 3h), weitere Notlichtvarianten auf Anfrage möglich

LED IP20

## Pendant light

- › Surface aluminium anodised
- › Cover opal for uniform illumination
- › Tool-free, height-adjustable steel cable suspension, L 3.000 mm
- › Direct/indirect light distribution for additional accentuation on ceiling
- › Energy-efficient low-power LEDs or fluorescent lights
- › XXX-E01 = LED lamp with emergency light (battery 3H), other emergency light variants available on request

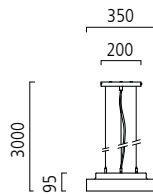

### Ø 350 x 95 mm

3000 K, 18 W, 74 lm/W, Ra > 80 3,9 kg

**121-021-203** ON/OFF

**121-021-223** DIM DALI

4000 K, 18 W, 80 lm/W, Ra > 80 3,9 kg

**121-021-204** ON/OFF

**121-021-224** DIM DALI

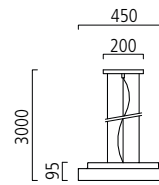

### Ø 450 x 95 mm

3000 K, 31 W, 76 lm/W, Ra > 80 6,2 kg

**121-022-203** ON/OFF

**121-022-223** DIM DALI

4000 K, 31 W, 83 lm/W, Ra > 80 6,2 kg

**121-022-204** ON/OFF

**121-022-224** DIM DALI

3000 K, 46 W, 78 lm/W, Ra > 80 6,2 kg

**121-026-203** ON/OFF

**121-026-223** DIM DALI

4000 K, 46 W, 82 lm/W, Ra > 80 6,2 kg

**121-026-204** ON/OFF

**121-026-224** DIM DALI

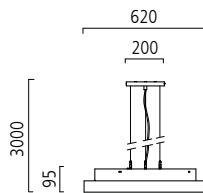

### Ø 620 x 95 mm

3000 K, 62 W, 79 lm/W, Ra > 80 15,0 kg

**121-023-203** ON/OFF

**121-023-223** DIM DALI

4000 K, 62 W, 86 lm/W, Ra > 80 15,0 kg

**121-023-204** ON/OFF

**121-023-224** DIM DALI

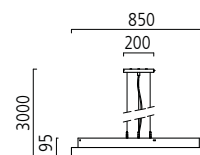

### Ø 850 x 95 mm

3000 K, 117 W, 77 lm/W, Ra > 80 27,0 kg

**121-024-203** ON/OFF

**121-024-223** DIM DALI

4000 K, 117 W, 84 lm/W, Ra > 80 27,0 kg

**121-024-204** ON/OFF

**121-024-224** DIM DALI

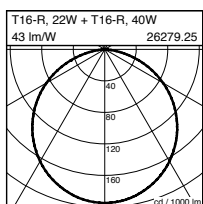
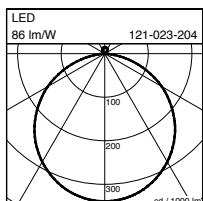

# CLEAR

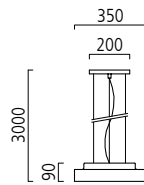

## Ø 350 x 90 mm

1 x TC-F, 18/24 W, 2G10 3,9 kg

- 16276.25** ON/OFF
- 16276.251** DIM 1-10V
- 16276.252** DIM DALI

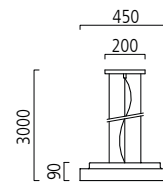

## Ø 450 x 90 mm

2 x TC-F, 24 W, 2G10 6,2 kg

- 26278.25** ON/OFF
- 26278.251** DIM 1-10V
- 26278.252** DIM DALI

1 x T16-R, 22 W, 2GX13 4,4 kg

- 16277.25** ON/OFF
- 16277.251** DIM 1-10V
- 16277.252** DIM DALI

1 x T16-R, 22 W, 2GX13 +

1 x T16-R, 40 W, 2GX13 6,0 kg

- 26279.25** ON/OFF
- 26279.251** DIM 1-10V
- 26279.252** DIM DALI

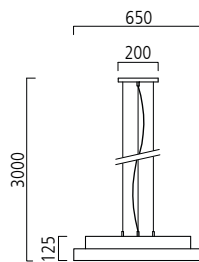

## Ø 650 x 125 mm

6 x TC-L, 18 W, 2G11 15,0 kg

- 66280.25** ON/OFF
- 66280.251** DIM 1-10V
- 66280.252** DIM DALI

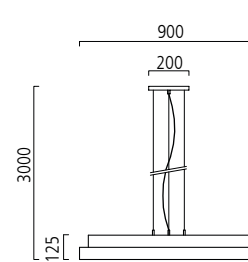

## Ø 900 x 125 mm

8 x TC-L, 18/24 W, 2G11 27,0 kg

- 86281.25** ON/OFF
- 86281.251** DIM 1-10V
- 86281.252** DIM DALI

# CLEAR LED

## Wand- und Deckenleuchte

- › Abgesetzter Leuchtenkörper
- › Oberfläche Aluminium eloxiert
- › Abdeckung opal für homogene Ausleuchtung
- › Lichtverteilung direkt/indirekt für zusätzliche Akzentuierung an der Wand/Decke
- › Energieeffiziente Low-Power-LEDs
- ›  XXX-E01 = Leuchte mit Notlicht (Batterie 3h), weitere Notlichtvarianten auf Anfrage möglich

LED IP20

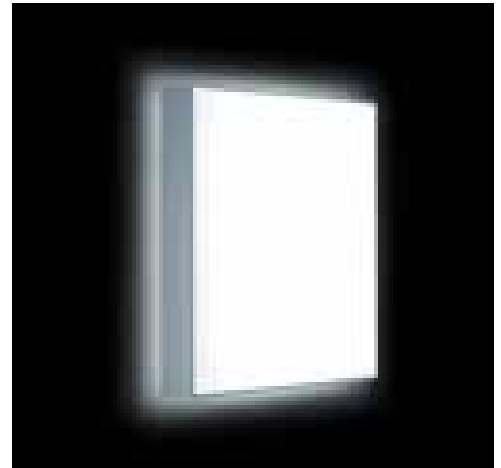
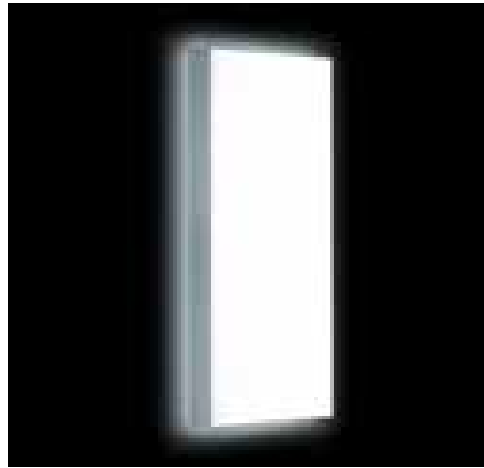

## Wall and ceiling light

- › Detached housing
- › Surface aluminium anodised
- › Cover opal for uniform illumination
- › Direct/indirect light distribution for additional accentuation on wall/ceiling
- › Energy-efficient low-power LEDs
- ›  XXX-E01 = lamp with emergency light (battery 3H), other emergency light variants available on request

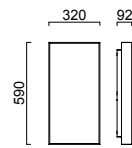

### 590 x 320 x 92 mm

3000 K, 23 W, 95 lm/W, Ra > 80 6,2 kg

**121-014-203** ON/OFF

**121-014-223** DIM DALI

4000 K, 23 W, 99 lm/W, Ra > 80 6,2 kg

**121-014-204** ON/OFF

**121-014-224** DIM DALI

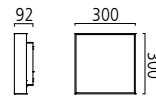

### 300 x 300 x 92 mm

3000 K, 12 W, 91 lm/W, Ra > 80 3,2 kg

**121-004-203** ON/OFF

**121-004-223** DIM DALI

4000 K, 12 W, 94 lm/W, Ra > 80 3,2 kg

**121-004-204** ON/OFF

**121-004-224** DIM DALI

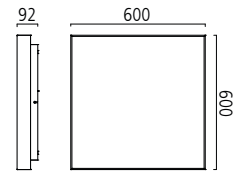

### 600 x 600 x 92 mm

3000 K, 43 W, 102 lm/W, Ra > 80 9,0 kg

**121-006-203** ON/OFF

**121-006-223** DIM DALI

4000 K, 43 W, 105 lm/W, Ra > 80 9,0 kg

**121-006-204** ON/OFF

**121-006-224** DIM DALI

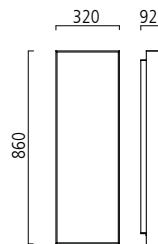
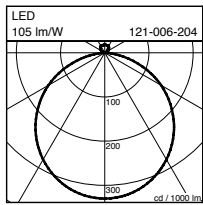

### 860 x 320 x 92 mm

3000 K, 33 W, 100 lm/W, Ra > 80 8,4 kg

**121-027-203** ON/OFF

**121-027-223** DIM DALI

4000 K, 33 W, 103 lm/W, Ra > 80 8,4 kg

**121-027-204** ON/OFF

**121-027-224** DIM DALI

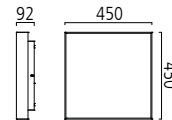

### 450 x 450 x 92 mm

3000 K, 34 W, 85 lm/W, Ra > 80 5,6 kg

**121-016-203** ON/OFF

**121-016-223** DIM DALI

4000 K, 34 W, 90 lm/W, Ra > 80 5,6 kg

**121-016-204** ON/OFF

**121-016-224** DIM DALI

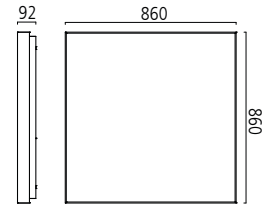

### 860 x 860 x 92 mm

3000 K, 94 W, 105 lm/W, Ra > 80 14,8 kg

**121-011-203** ON/OFF

**121-011-223** DIM DALI

4000 K, 94 W, 109 lm/W, Ra > 80 14,8 kg

**121-011-204** ON/OFF

**121-011-224** DIM DALI

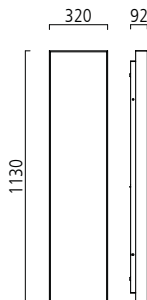

### 1.130 x 320 x 92 mm

3000 K, 43 W, 102 lm/W, Ra > 80 10,5 kg

**121-015-203** ON/OFF

**121-015-223** DIM DALI

4000 K, 43 W, 105 lm/W, Ra > 80 10,5 kg

**121-015-204** ON/OFF

**121-015-224** DIM DALI





# CLEAR

## Wand- und Deckenleuchte

- › Abgesetzter eckiger Leuchtenkörper
- › Oberfläche Aluminium eloxiert
- › Abdeckung opal für homogene Ausleuchtung
- › Lichtverteilung direkt/indirekt für zusätzliche Akzentuierung an der Wand/Decke
- › Notbeleuchtung auf Anfrage



## Wall and ceiling light

- › Detached housing
- › Surface aluminium anodised
- › Cover opal for uniform illumination
- › Direct/indirect light distribution for additional accentuation on wall/ceiling
- › Emergency lighting on request

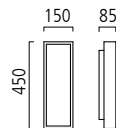
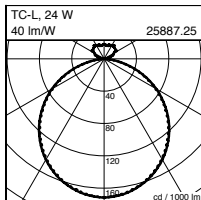
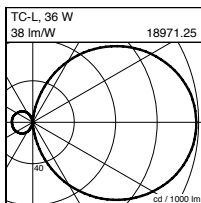
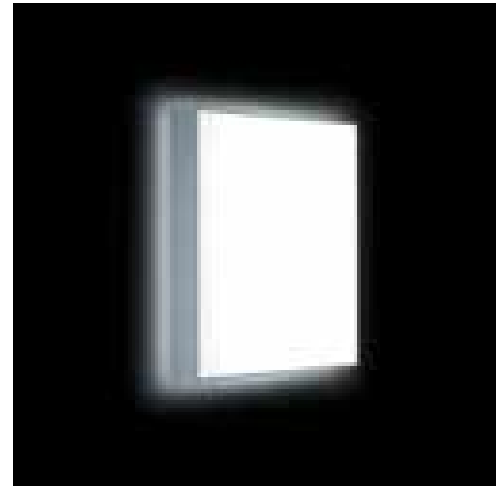
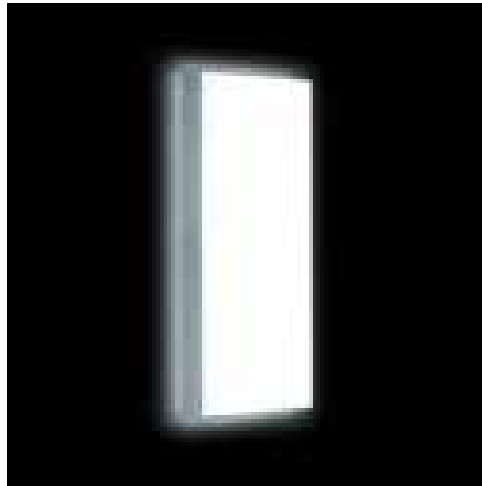

**450 x 150 x 85 mm**  
 1 x TC-L, 24 W, 2G11 2,8 kg  
**18970.25** ON/OFF

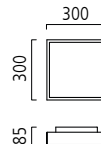

**300 x 300 x 85 mm**  
 1 x TC-F, 18/24 W, 2G10 3,2 kg  
**15885.25** ON/OFF

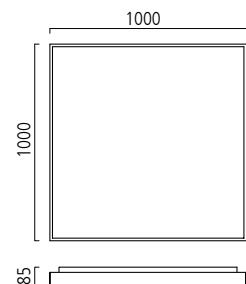

**1.000 x 1.000 x 85 mm**  
 4 x T16, 21/39 W, G5 21,0 kg  
**45913.25** ON/OFF  
**45913.251** DIM 1-10V  
**45913.252** DIM DALI

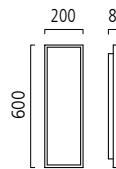

**600 x 200 x 85 mm**  
 1 x TC-L, 36 W, 2G11 4,3 kg  
**18971.25** ON/OFF  
**18971.251** DIM 1-10V  
**18971.252** DIM DALI

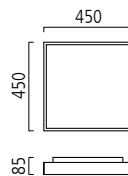

**450 x 450 x 85 mm**  
 1 x T16-R, 40 W, 2GX13 5,6 kg  
**15886.25** ON/OFF  
**15886.251** DIM 1-10V  
**15886.252** DIM DALI  
 2 x TC-L, 24 W, 2G11 5,8 kg  
**25887.25** ON/OFF  
**25887.251** DIM 1-10V  
**25887.252** DIM DALI

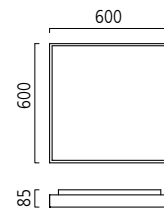

**600 x 600 x 85 mm**  
 1 x T16-R, 22 W, 2GX13 +  
 1 x T16-R, 40 W, 2GX13 8,7 kg  
**25888.25** ON/OFF  
**25888.251** DIM 1-10V  
**25888.252** DIM DALI  
 2 x TC-L, 36 W, 2G11 9,0 kg  
**25889.25** ON/OFF  
**25889.251** DIM 1-10V  
**25889.252** DIM DALI  
 3 x TC-L, 36 W, 2G11 9,2 kg  
**35889.25** ON/OFF  
**35889.251** DIM 1-10V  
**35889.252** DIM DALI

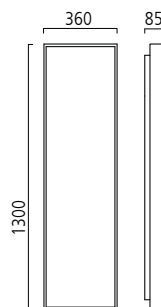

**1.300 x 360 x 85 mm**  
 2 x T16, 28/54 W, G5 11,5 kg  
**28972.25** ON/OFF  
**28972.251** DIM 1-10V  
**28972.252** DIM DALI



# CLEAR 2 LED / CLEAR 2

## Wand- und Deckenleuchte

- › Oberfläche Aluminium eloxiert
- › Abdeckung opal für homogene Ausleuchtung
- › Lichtverteilung direkt
- › Energieeffiziente Low-Power-LEDs oder Leuchtstofflampen
- ›  XXX-E01 = LED Leuchte mit Notlicht (Batterie 3h), weitere Notlichtvarianten auf Anfrage möglich

**LED IP20**

## Wall and ceiling light

- › Surface aluminium anodised
- › Cover opal for uniform illumination
- › Direct light distribution
- › Energy-efficient low-power LEDs or fluorescent lights
- ›  XXX-E01 = LED lamp with emergency light (battery 3H), other emergency light variants available on request

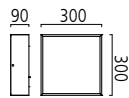
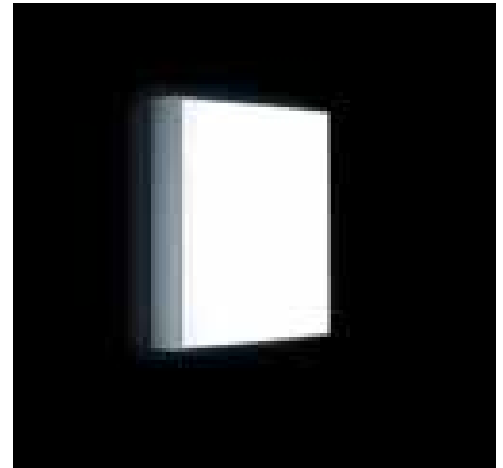
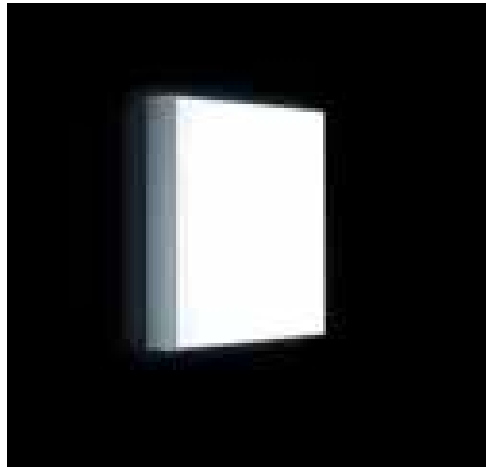

**300 x 300 x 90 mm**  
 3000 K, 12 W, 87 lm/W, Ra > 80 3,8 kg  
**121-007-203** ON/OFF  
**121-007-223** DIM DALI  
 4000 K, 12 W, 89 lm/W, Ra > 80 3,8 kg  
**121-007-204** ON/OFF  
**121-007-224** DIM DALI

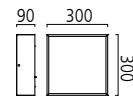

**300 x 300 x 90 mm**  
 1 x T16-R, 22 W, 2GX13 3,8 kg  
**15167.25** ON/OFF  
**15167.251** DIM 1-10V  
**15167.252** DIM DALI

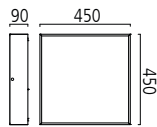
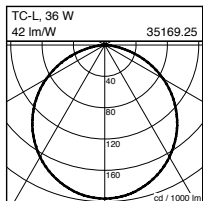
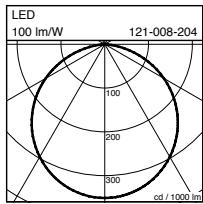

**450 x 450 x 90 mm**  
 3000 K, 33 W, 83 lm/W, Ra > 80 5,6 kg  
**121-025-203** ON/OFF  
**121-025-223** DIM DALI  
 4000 K, 33 W, 88 lm/W, Ra > 80 5,6 kg  
**121-025-204** ON/OFF  
**121-025-224** DIM DALI

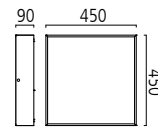

**450 x 450 x 90 mm**  
 3 x TC-L, 36 W, 2G11 5,8 kg  
**35169.25** ON/OFF  
**35169.251** DIM 1-10V  
**35169.252** DIM DALI

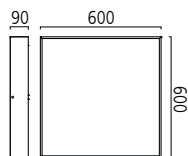

**600 x 600 x 90 mm**  
 3000 K, 43 W, 97 lm/W, Ra > 80 8,8 kg  
**121-008-203** ON/OFF  
**121-008-223** DIM DALI  
 4000 K, 43 W, 100 lm/W, Ra > 80 8,8 kg  
**121-008-204** ON/OFF  
**121-008-224** DIM DALI

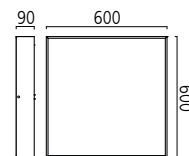

**600 x 600 x 90 mm**  
 4 x T16, 14/24 W, G5 8,8 kg  
**45170.25** ON/OFF  
**45170.251** DIM 1-10V  
**45170.252** DIM DALI



# CLEAR LED

## Pendelleuchte

- › Oberfläche Aluminium eloxiert
- › Abdeckung opal für homogene Ausleuchtung
- › Werkzeuglos höhenverstellbare Stahlseilaufhängung, L 3.000 mm
- › Lichtverteilung direkt/indirekt für zusätzliche Akzentuierung an der Decke
- › Energieeffiziente Low-Power-LEDs oder Leuchtstofflampen
- ›  XXX-E01 = LED Leuchte mit Notlicht (Batterie 3h), weitere Notlichtvarianten auf Anfrage möglich

**LED** **IP20**

## Pendant light

- › Surface aluminium anodised
- › Cover opal for uniform illumination
- › Tool-free, height-adjustable steel cable suspension, L 3.000 mm
- › Direct/indirect light distribution for additional accentuation on ceiling
- › Energy-efficient low-power LEDs or fluorescent lights
- ›  XXX-E01 = LED lamp with emergency light (battery 3H), other emergency light variants available on request

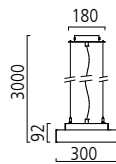

### 300 x 300 x 92 mm

3000 K, 12 W, 91 lm/W, Ra > 80	4,6 kg
<b>121-017-203</b>	ON/OFF
<b>121-017-223</b>	DIM DALI
4000 K, 12 W, 94 lm/W, Ra > 80	4,6 kg
<b>121-017-204</b>	ON/OFF
<b>121-017-224</b>	DIM DALI

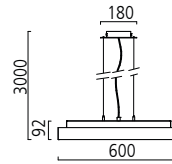

### 600 x 600 x 92 mm

3000 K, 43 W, 102 lm/W, Ra > 80	13,4 kg
<b>121-019-203</b>	ON/OFF
<b>121-019-223</b>	DIM DALI
4000 K, 43 W, 105 lm/W, Ra > 80	13,4 kg
<b>121-019-204</b>	ON/OFF
<b>121-019-224</b>	DIM DALI

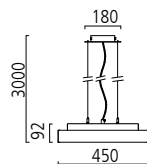
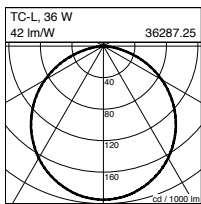
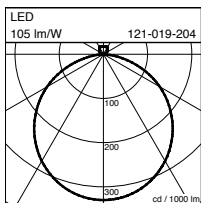

### 450 x 450 x 92 mm

3000 K, 34 W, 85 lm/W, Ra > 80	8,4 kg
<b>121-018-203</b>	ON/OFF
<b>121-018-223</b>	DIM DALI
4000 K, 34 W, 90 lm/W, Ra > 80	8,4 kg
<b>121-018-204</b>	ON/OFF
<b>121-018-224</b>	DIM DALI

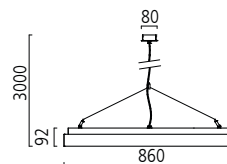

### 860 x 860 x 92 mm

3000 K, 94 W, 105 lm/W, Ra > 80	19,8 kg
<b>121-020-203</b>	ON/OFF
<b>121-020-223</b>	DIM DALI
4000 K, 94 W, 109 lm/W, Ra > 80	19,8 kg
<b>121-020-204</b>	ON/OFF
<b>121-020-224</b>	DIM DALI



# CLEAR

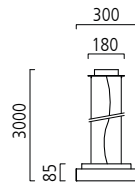

**300 x 300 x 85 mm**  
 1 x TC-F, 18/24 W, 2GX10 4,6 kg  
**16282.25** ON/OFF

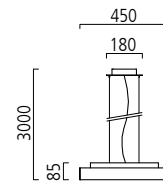

**450 x 450 x 85 mm**  
 1 x T16-R, 40 W, 2GX13 8,4 kg  
**16283.25** ON/OFF  
**16283.251** DIM 1-10V  
**16283.252** DIM DALI  
 2 x TC-L, 24 W, 2G11 8,5 kg  
**26284.25** ON/OFF  
**26284.251** DIM 1-10V  
**26284.252** DIM DALI

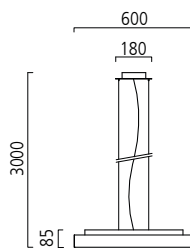

**600 x 600 x 85 mm**  
 1 x T16-R, 22 W, 2GX13 +  
 1 x T16-R, 40 W, 2GX13 13,4 kg  
**26285.25** ON/OFF\*  
**26285.251** DIM 1-10V\*  
**26285.252** DIM DALI\*  
 2 x TC-L, 36 W, 2G11 13,6 kg  
**26286.25** ON/OFF\*  
**26286.251** DIM 1-10V\*  
**26286.252** DIM DALI\*  
 3 x TC-L, 36 W, 2G11 13,7 kg  
**36287.25** ON/OFF\*  
**36287.251** DIM 1-10V\*  
**36287.252** DIM DALI\*

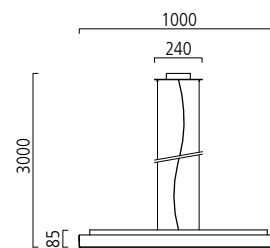

**1.000 x 1000 x 85 mm**  
 4 x T16, 21/39 W, G5 28,6 kg  
**46288.25** ON/OFF\*  
**46288.251** DIM 1-10V\*  
**46288.252** DIM DALI\*

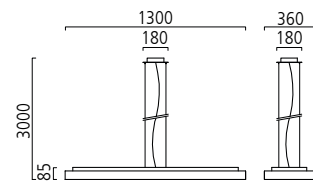

**1.300 x 360 x 85 mm**  
 2 x T16, 28/54 W, G5 16,0 kg  
**26289.25** ON/OFF  
**26289.251** DIM 1-10V  
**26289.252** DIM DALI

\* nur direkte Lichtverteilung  
 direct light distribution only

Kennzeichnend für STEN sind die formale Reduktion und eine dezente Materialität mit Edelstahl-Optik und weißem Acryl, die durch das silberne Siebdruckdekor noch unterstrichen wird. Mit reduziertem Design, unterschiedlichen Größen und einer optionalen Notlichtfunktion schafft STEN Beleuchtungslösungen für kleine Hallen, Eingangsbereiche, Flure und Treppenhäuser.

Characteristics of STEN are formal minimalism and an unpretentious material combination with stainless steel finish and white acrylic, accentuated by its silvery screen print decor. With minimalist design, several different sizes and an optional emergency lighting function, STEN offers lighting solutions for small halls, entrance areas, corridors and staircases.





STEN

# STEN

## Wand- und Deckenleuchte

- › Dekor Edelstahl-finish
- › Robustes Gehäuse aus stabilem Acryl
- › Abdeckung opal für homogene Ausleuchtung
- › Lichtverteilung direkt/indirekt
- › Energieeffiziente Kompakt-Leuchtstofflampen
- › Notbeleuchtung auf Anfrage



## Wall- and Ceiling light

- › Surface stainless steel finish
- › Robust cover made of solid acrylic
- › Cover opal for uniform illumination
- › Direct/indirect light distribution
- › Energy-efficient compact fluorescent lamps
- › Emergency lighting on request

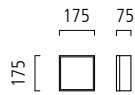

**175 x 175 x 75 mm**  
 1 x TC-F, 18 W, 2G10 1,4 kg  
**18247.86** ON/OFF

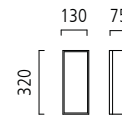

**320 x 130 x 75 mm**  
 1 x TC-L, 18 W, 2G11 1,7 kg  
**18248.86** ON/OFF

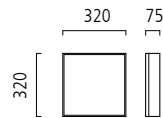
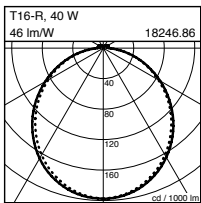
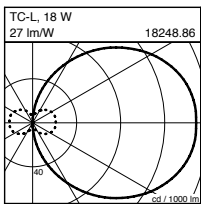

**320 x 320 x 75 mm**  
 1 x T16-R, 22 W, 2GX13 3,4 kg  
**18972.86** ON/OFF  
**18972.861** DIM 1-10V  
**18972.862** DIM DALI

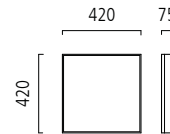

**420 x 420 x 75 mm**  
 1 x T16-R, 40 W, 2GX13 5,6 kg  
**18246.86** ON/OFF  
**18246.861** DIM 1-10V  
**18246.862** DIM DALI

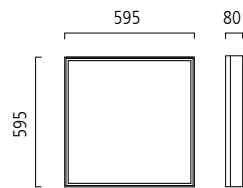

**595 x 595 x 80 mm**  
 4 x T16, 14/24 W, G5 7,3 kg  
**48970.86** ON/OFF  
**48970.861** DIM 1-10V  
**48970.862** DIM DALI



Die verschiedenen organischen Formen der CLOUD Wand- und Deckenleuchten laden zur freien Gestaltung großer Flächen ein. Mit dem breiten Lichtband aus satiniertem Acrylglas, das sich scheinbar um eine Abdeckung aus eloxiertem Aluminium windet, ist sie Hingucker und Leuchte gleichermaßen. Das Design erhielt internationale Auszeichnungen wie den Red Dot Award oder die Nominierung für den Designpreis der Bundesrepublik Deutschland.

The various organic forms of CLOUD wall and ceiling lights encourage creative design of large areas. With a broad band of light made of satinised acrylic glass, which seems to wind around an anodized aluminium cover, it is luminaire and eye-catcher in one. This design has won international prizes such as the Red Dot Award and nomination for the Design Award of the Federal Republic of Germany.

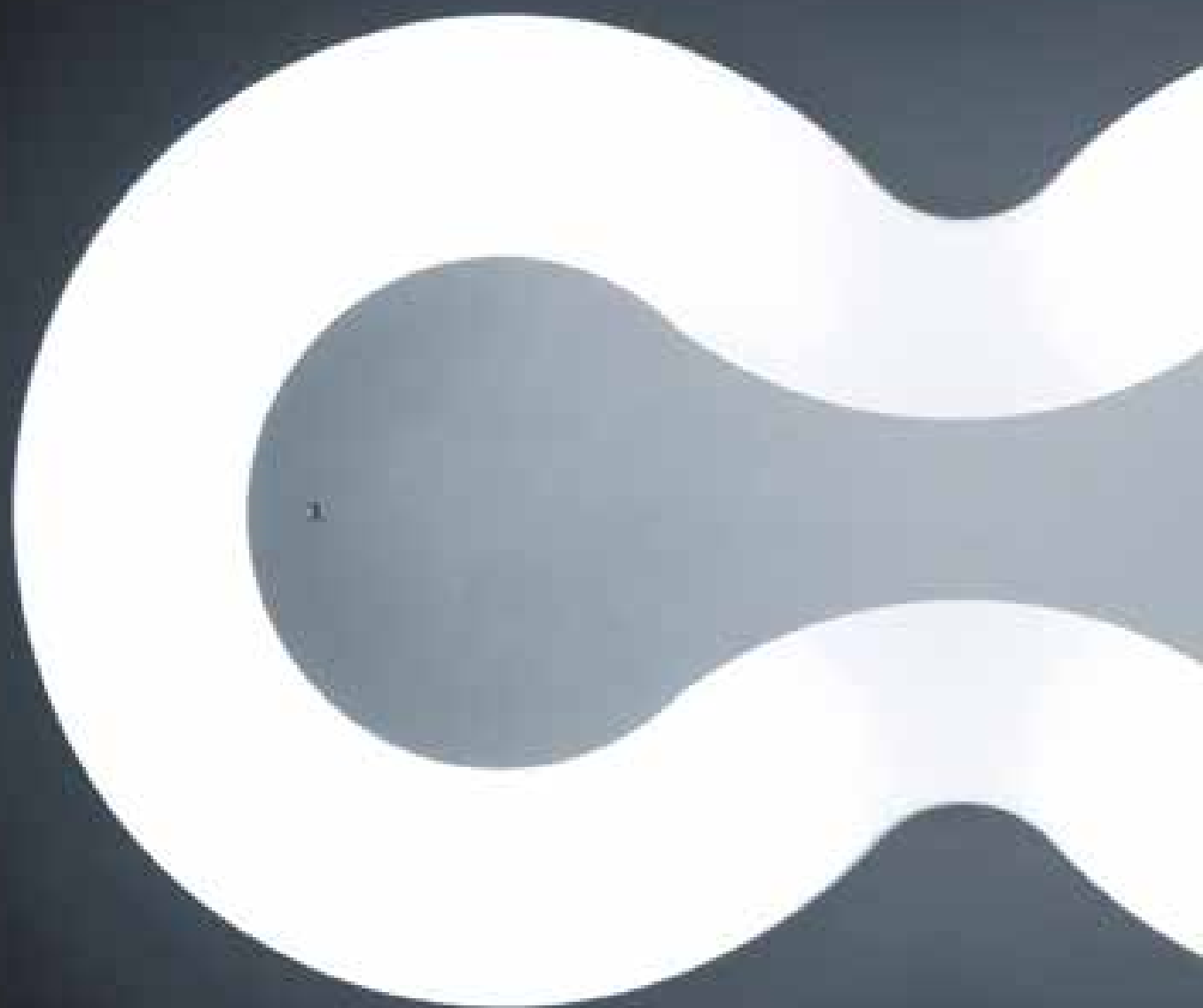

CLOUD

# CLOUD

## Wand- und Deckenleuchte

- › Oberfläche Aluminium eloxiert
- › Abdeckung opal für homogene Ausleuchtung und diffuse Lichtwirkung
- › Lichtverteilung direkt/indirekt



## Wall and ceiling light

- › Surface aluminium anodised
- › Cover opal for uniform illumination and excellent light diffusion
- › Direct/indirect light distribution

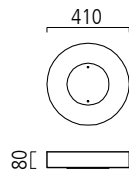
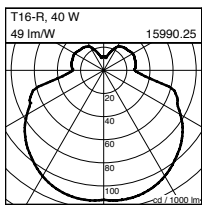
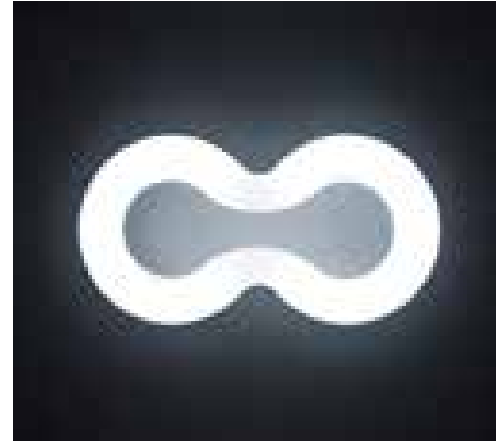

**Ø 410 x 80 mm**  
 1 x T16-R, 40 W, 2GX13 3,4 kg

<b>15990.25</b>	ON/OFF
<b>15990.251</b>	DIM 1-10V
<b>15990.252</b>	DIM DALI

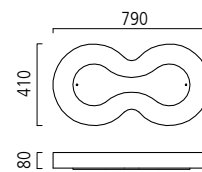

**790 x 410 x 80 mm**  
 2 x T16-R, 40 W, 2GX13 6,2 kg

<b>25989.25</b>	ON/OFF
<b>25989.251</b>	DIM 1-10V
<b>25989.252</b>	DIM DALI

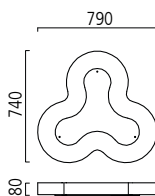
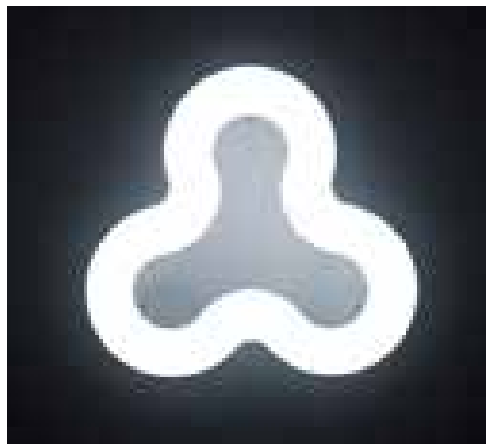

**790 x 740 x 80 mm**  
 3 x T16-R, 40 W, 2GX13 9,1 kg

<b>35988.25</b>	ON/OFF
<b>35988.251</b>	DIM 1-10V
<b>35988.252</b>	DIM DALI



red dot



HERMANN FINKE  
 LIGHTING





INSIDE ist die ideale Lichtlösung für Verkaufsräume oder die Präsentation ausgewählter Objekte. Innerhalb der runden oder viereckigen Leuchte kommen dekorative Inhalte besonders zur Geltung. Ihre zeitgemäße Materialkombination aus eloxiertem Aluminium und satiniertem Acrylglas fügt sich gleichermaßen in gewerbliche wie private Umgebungen ein.

INSIDE is the ideal lighting solution for showrooms or highlighting of selected objects. Within these round or square luminaires, decorative elements are particularly accentuated. Their modern material combination of anodised aluminium with satinised acrylic glass fits equally well into commercial and private environments.





INSIDE





INSIDE

# INSIDE / INSIDE LED

## Wandleuchte

- › Für die Präsentation dekorativer Objekte
- › Oberfläche Aluminium eloxiert
- › Abdeckung satiniert für homogene Ausleuchtung
- › Energieeffiziente Low-Power LEDs oder Kompaktleuchtstofflampen
- › Lichtverteilung indirekt



## Wall light

- › For the presentation of decorative objects
- › Surface aluminium anodised
- › Cover satinised for uniform illumination
- › Energy-efficient Low-power LEDs or fluorescent lights
- › Indirect light distribution

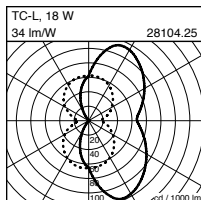
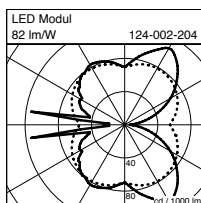
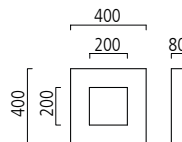
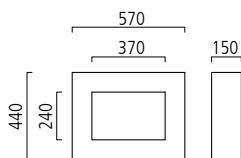
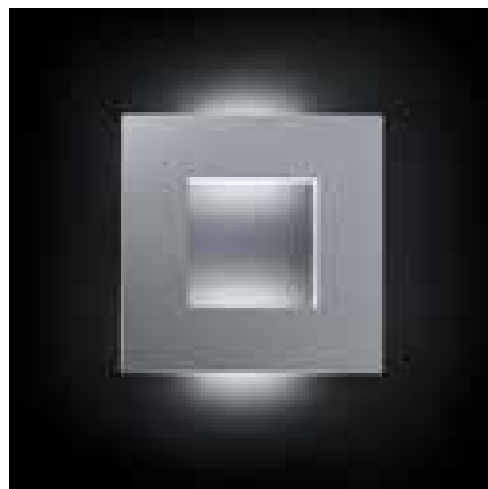
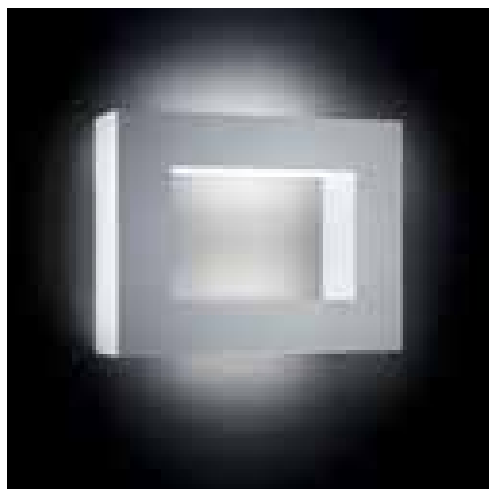

<b>570 x 440 x 150 mm</b>	
3000 K, 27 W, 78 lm/W, Ra>80	7,6 kg
<b>124-002-203</b>	ON/OFF
<b>124-002-223</b>	DIM DALI
4000 K, 27 W, 82 lm/W, Ra>80	7,6 kg
<b>124-002-204</b>	ON/OFF
<b>124-002-224</b>	DIM DALI

<b>400 x 400 x 80 mm</b>	
3000 K, 24 W, 75 lm/W, Ra>80	5 kg
<b>124-001-203</b>	ON/OFF
<b>124-001-223</b>	DIM DALI
4000 K, 24 W, 79 lm/W, Ra>80	5 kg
<b>124-001-204</b>	ON/OFF
<b>124-001-224</b>	DIM DALI

<b>570 x 440 x 150 mm</b>	
2 x TC-L, 24 W, 2G11	7,5 kg
<b>28103.25</b>	ON/OFF
<b>28103.251</b>	DIM 1-10V
<b>28103.252</b>	DIM DALI

<b>400 x 400 x 80 mm</b>	
2 x TC-L, 18 W, 2G11	5 kg
<b>28104.25</b>	ON/OFF
<b>28104.251</b>	DIM 1-10V
<b>28104.252</b>	DIM DALI



DESIGN PLUS





# INSIDE

## Wand- und Deckenleuchte

- › Oberfläche Aluminium lackiert oder Acryl opal
- › Abdeckung satiniert oder opal für homogene Ausleuchtung
- › Lichtverteilung direkt oder direkt / indirekt



## Wall and ceiling light

- › Surface painted aluminium or acrylic opal
- › Cover satinised or opal for uniform illumination
- › Indirect or direct / indirect light distribution

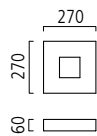
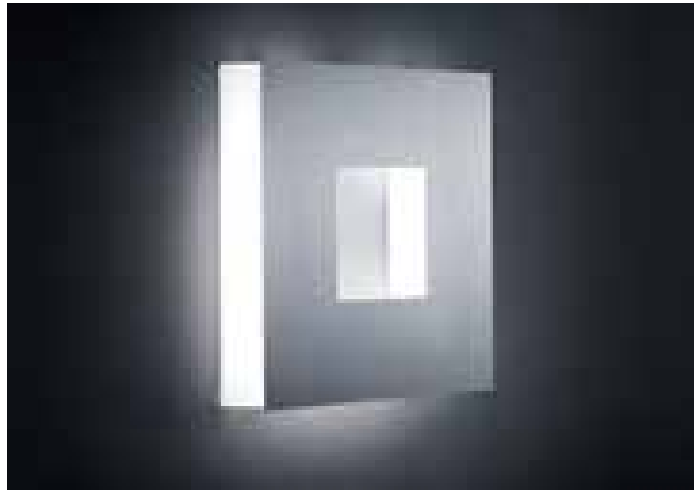

**270 x 270 x 60 mm**

1 x T16-R, 22 W, 2GX13 1,9 kg

**15856.25** ON/OFF

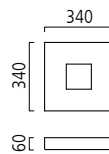

**340 x 340 x 60 mm**

1 x T16-R, 40 W, 2GX13 2,6 kg

**15857.25** ON/OFF

**15857.251** DIM 1-10V

**15857.252** DIM DALI

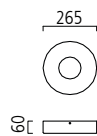
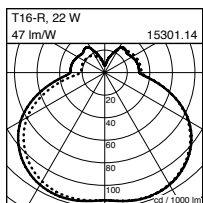
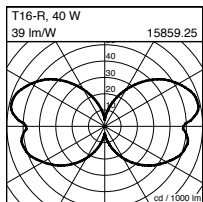
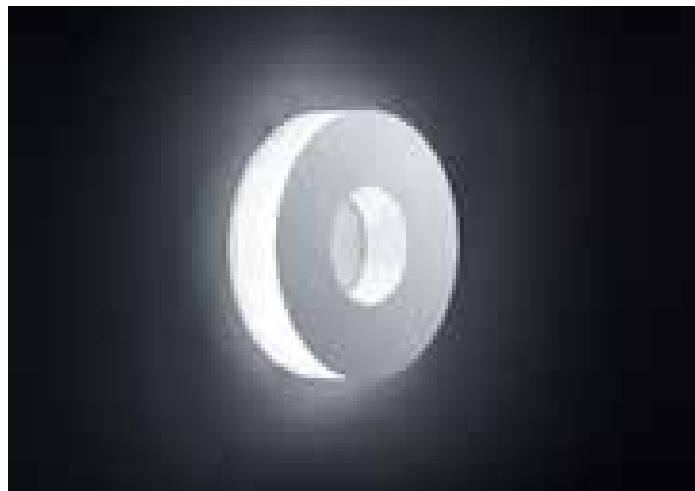

**Ø 265 x 60 mm**

1 x T16-R, 22 W, 2GX13 1,7 kg

**15858.25** ON/OFF

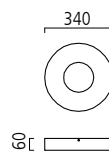

**Ø 340 x 60 mm**

1 x T16-R, 40 W, 2GX13 2,5 kg

**15859.25** ON/OFF

**15859.251** DIM 1-10V

**15859.252** DIM DALI

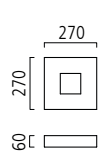

**270 x 270 x 60 mm**  
 1 x T16-R, 22 W, 2GX13 1,5 kg  
**15301.14** ON/OFF

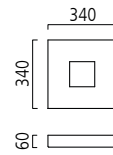

**340 x 340 x 60 mm**  
 1 x T16-R, 40 W, 2GX13 2,4 kg  
**15302.14** ON/OFF  
**15302.141** DIM 1-10V  
**15302.142** DIM DALI

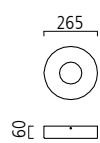

**Ø 265 x 60 mm**  
 1 x T16-R, 22 W, 2GX13 1,4 kg  
**15299.14** ON/OFF

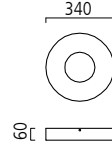

**Ø 340 x 60 mm**  
 1 x T16-R, 40 W, 2GX13 2 kg  
**15300.14** ON/OFF  
**15300.141** DIM 1-10V  
**15300.142** DIM DALI

SLIM Wandleuchten setzen mit einem satinieren Acrylgehäuse und einer geschlitzten Aluminiumabdeckung einen interessanten Akzent. Das Spiel mit unterschiedlichen Ausrichtungen – waagerechte oder senkrechte Montage – lädt dazu ein, Wandflächen kreativ zu gestalten. Ausgezeichnet mit den internationalen Designpreisen iF, Red Dot und Design Plus sowie einer Nominierung für den Designpreis der Bundesrepublik Deutschland.

With their satinised acrylic housing and slotted aluminium cover, SLIM wall lights set interesting highlights. The option of different orientations – horizontal or vertical installation – is an open invitation for creative wall design. Winner of the international design awards iF, Red Dot and Design Plus and nomination for the Design Award of the Federal Republic of Germany.





SLIM

# SLIM

## Wandleuchte

- › Mit dekorativem Lichtschlitz
- › Oberfläche Aluminium lackiert
- › Abdeckung opal für homogene Ausleuchtung
- › Lichtverteilung indirekt



## Wall light

- › With decorative light slot
- › Surface painted aluminium
- › Cover opal for uniform illumination
- › Indirect light distribution

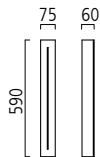
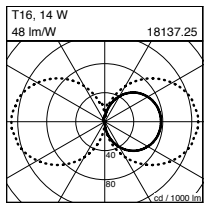
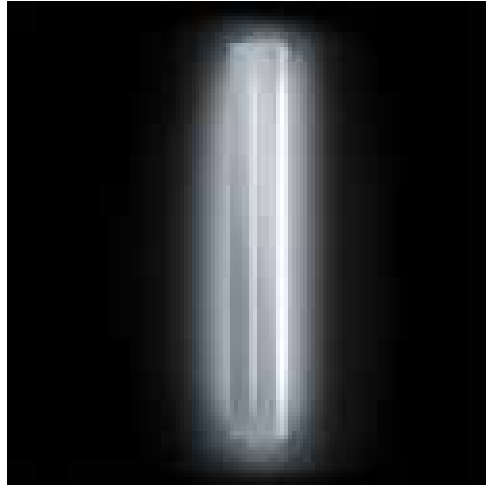

**590 x 75 x 60 mm**

1 x T16, 24 W, G5 2 kg

<b>18137.25</b>	ON/OFF
<b>18137.251</b>	DIM 1-10V
<b>18137.252</b>	DIM DALI



reddot



DESIGN AWARD  
iF



DESIGN AWARD  
iF



DESIGN PLUS



Die Wand- und Deckenleuchte mit rundem Leuchtenkörper aus einer satinieren Acrylröhre und einem Leuchtgehäuse in Edelstahloptik hat mit der Analogie zur Leuchtstoffröhre einen industriellen Charakter. Dabei wirkt sie solide und stabil, ohne plump zu sein und ergänzt gezielt die Grundbeleuchtung.

This wall and ceiling light range, featuring a round, satinised acrylic tube set in a housing in stainless steel look, has an industrial character with a similarity to fluorescent tubes. It looks solid and stable without being clumsy and complements basic lighting in a targeted way.



GAME

# GAME

## Wandleuchte

- › Oberfläche Edelstahl-finish
- › Abdeckung satiniert für  
homogene Ausleuchtung
- › Lichtverteilung direkt/indirekt



## Wall light

- › Surface stainless steel finish
- › Cover satinised for  
uniform illumination
- › Direct/indirect light distribution

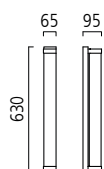
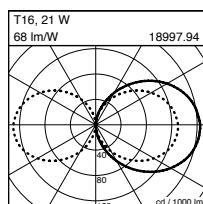

**630 x 65 x 95 mm**

1 x T16, 14/24 W, G5 3,3 kg

**18996.94** ON/OFF

**18996.941** DIM 1-10V

**18996.942** DIM DALI

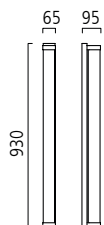

**930 x 65 x 95 mm**

1 x T16, 21/39 W, G5 4 kg

**18997.94** ON/OFF

**18997.941** DIM 1-10V

**18997.942** DIM DALI





Als Einzelleuchte oder als Leuchten-  
gruppe ist TOOL die ideale Lösung für  
sehr hohe Räume, Treppenhäuser und  
speziell für Kirchen. Die lichtleitenden,  
satinierten Acrylröhren lassen sich über  
ein höhenverstellbares Stahlseil indi-  
viduell positionieren. Ein Downlight  
schafft optional zusätzliche Lichteffekte.

As an individual luminaire or a group  
of lights, TOOL is the ideal solution for  
rooms with high ceilings, staircases and  
especially church buildings. The light-  
conducting, satinised acrylic tubes  
can be positioned individually via a  
height-adjustable steel cable. A down  
light provides additional lighting effects  
as an option.





TOOL

# TOOL

## Pendelleuchte

- › Oberfläche mattnickel
- › Abdeckung satiniert für homogene Ausleuchtung
- › Downlight-Varianten bieten zusätzliche Lichteffekte
- › Werkzeuglos höhenverstellbare Stahlseilaufhängung kürzbar, L 5.000 mm
- › Lichtverteilung direkt/indirekt



## Pendant light

- › Surface nickel mat
- › Cover satinised for uniform illumination
- › Luminaires with additional downlights available
- › Tool-free, height-adjustable steel cable suspension, L 5.000 mm
- › Direct/indirect light distribution

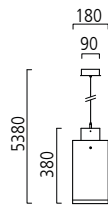

**Ø 180 x 380 mm**

1 x TC-TEL, 26/32/42 W, GX24q-3/4 3,1 kg

- 16207.06** ON/OFF
- 16207.061** DIM 1-10V
- 16207.062** DIM DALI

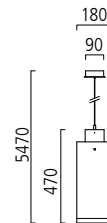

**Ø 180 x 470 mm**

2 x TC-L, 18 W, 2G11 4,2 kg

- 26209.06** ON/OFF
- 26209.061** DIM 1-10V
- 26209.062** DIM DALI

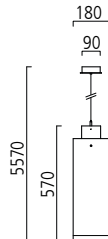
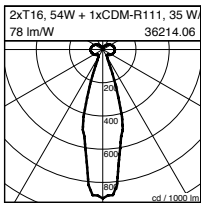
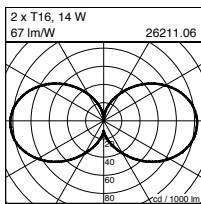

**Ø 180 x 570 mm**

2 x TC-L, 24 W, 2G11 4,9 kg

- 26210.06** ON/OFF
- 26210.061** DIM 1-10V
- 26210.062** DIM DALI

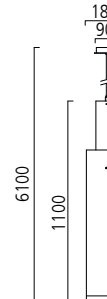

**Ø 180 x 1.100 mm**

2 x T16, 14/24 W, G5 5 kg

- 26211.06** ON/OFF
- 26211.061** DIM 1-10V
- 26211.062** DIM DALI

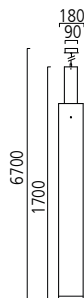

**Ø 180 x 1.700 mm**

2 x T16, 28/54 W, G5 6,4 kg

- 26213.06** ON/OFF
- 26213.061** DIM 1-10V
- 26213.062** DIM DALI

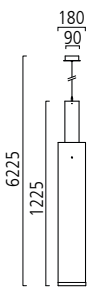

**Ø 180 x 1.225 mm**

mit Downlight / with Downlight

2 x T16, 14/24 W, G5 +

1 x CDM-R111, 35 W, GX8,5 5,2 kg

- 36212.06** ON/OFF
- 36212.061** DIM 1-10V
- 36212.062** DIM DALI

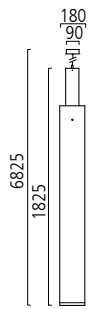

**Ø 180 x 1.825 mm**

mit Downlight / with Downlight

2 x T16, 28/54 W, G5 +

1 x CDM-R111, 35 W, GX8,5 6,8 kg

- 36214.06** ON/OFF
- 36214.061** DIM 1-10V
- 36214.062** DIM DALI





Mit einer maximalen Länge von 11 Metern, vier satinierten Acrylröhren und freistrahrender Lichtverteilung ist die Pendelleuchte TOOL 2 ideal für Treppenhäuser oder hohe Räume geeignet. Die Wandleuchte TOOL 2 bringt das Licht direkt an die gewünschte Stelle und vervollständigt so die Beleuchtung.

With a maximum length of 11 metres, four satinised acrylic tubes and freely radiating light distribution, the TOOL 2 pendant is ideal for staircases or rooms with high ceilings. The TOOL 2 wall light directs the light to the desired spot and thus completes the illumination.



# TOOL 2





# TOOL 2

# TOOL 2

## Pendelleuchte

- › Oberfläche Aluminium eloxiert
- › Abdeckung satiniert für homogene Ausleuchtung
- › Sehr hohe Effizienz
- › Werkzeugloser Leuchtmittelwechsel
- › Werkzeuglos höhenverstellbare Stahlseilaufhängung  
L 5.000 mm oder L 10.000 mm
- › Lichtverteilung direkt/indirekt
- › Notbeleuchtung auf Anfrage



## Pendant light

- › Surface aluminium anodised
- › Cover satinised for uniform illumination
- › Very high efficiency
- › Tool-free exchange of lamps
- › Tool-free, height-adjustable steel cable suspension,  
L 5.000 mm or L 10.000 mm
- › Direct/indirect light distribution
- › Emergency lighting on request

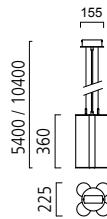

**225 x 225 x 360 mm**

**L 5.400 mm**

4 x TC-L, 24 W, 2G11 5,3 kg

**46460.250** ON/OFF

**46460.251** DIM 1-10V

**46460.252** DIM DALI

**L 10.400 mm** 5,4 kg

**46461.250** ON/OFF

**46461.251** DIM 1-10V

**46461.252** DIM DALI

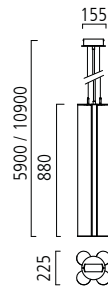

**225 x 225 x 880 mm**

**L 5.900 mm**

4 x T16, 21/39 W, G5 8,4 kg

**46464.250** ON/OFF

**46464.251** DIM 1-10V

**46464.252** DIM DALI

**L 10.900 mm** 8,5 kg

**46465.250** ON/OFF

**46465.251** DIM 1-10V

**46465.252** DIM DALI

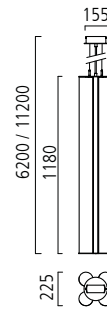

**225 x 225 x 1.180 mm**

**L 6.200 mm**

4 x T16, 28/54 W, G5 9,9 kg

**46466.250** ON/OFF

**46466.251** DIM 1-10V

**46466.252** DIM DALI

**L 11.200 mm** 10,0 kg

**46467.250** ON/OFF

**46467.251** DIM 1-10V

**46467.252** DIM DALI

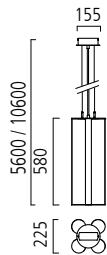
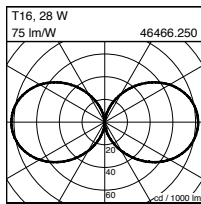

**225 x 225 x 580 mm**

**L 5.600 mm**

4 x T16, 14/24 W, G5 6,4 kg

**46462.250** ON/OFF

**46462.251** DIM 1-10V

**46462.252** DIM DALI

**L 10.600 mm** 6,5 kg

**46463.250** ON/OFF

**46463.251** DIM 1-10V

**46463.252** DIM DALI





# TOOL 2

## Wand- und Deckenleuchte

- › Oberfläche Aluminium eloxiert
- › Abdeckung satiniert für homogene Ausleuchtung
- › Sehr hohe Effizienz
- › Werkzeugloser Leuchtmittelwechsel
- › Lichtverteilung direkt/indirekt
- › Notbeleuchtung auf Anfrage möglich



## Wall and ceiling light

- › Surface aluminium anodised
- › Cover satinised for uniform illumination
- › Very high efficiency
- › Tool-free exchange of lamps
- › Direct/indirect light distribution
- › Emergency Lighting on Request

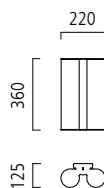
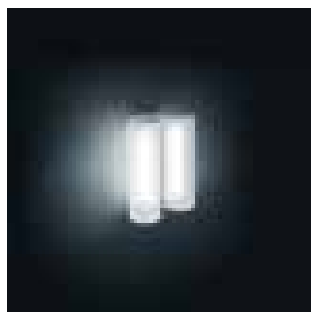

**360 x 220 x 125 mm**  
2 x TC-L, 24 W, 2G11 2,8 kg

**28264.250** ON/OFF  
**28264.251** DIM 1-10V  
**28264.252** DIM DALI

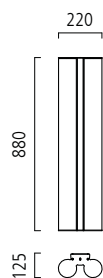

**880 x 220 x 125 mm**  
2 x T16, 21/39 W, G5 5 kg

**28266.250** ON/OFF  
**28266.251** DIM 1-10V  
**28266.252** DIM DALI

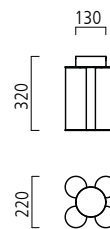

**220 x 220 x 320 mm**  
4 x TC-L, 18 W, 2G11 5,2 kg

**45545.250** ON/OFF  
**45545.251** DIM 1-10V  
**45545.252** DIM DALI

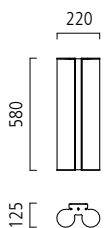
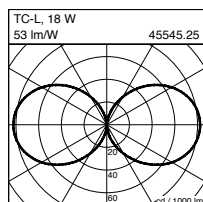
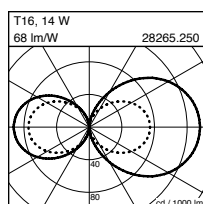

**580 x 220 x 125 mm**  
2 x T16, 14/24 W, G5 3,7 kg

**28265.250** ON/OFF  
**28265.251** DIM 1-10V  
**28265.252** DIM DALI



**1.180 x 220 x 125 mm**  
2 x T16, 28/54 W, G5 6,6 kg

**28267.250** ON/OFF  
**28267.251** DIM 1-10V  
**28267.252** DIM DALI





Die leuchtende Kugel übernimmt die Funktion der Allgemeinbeleuchtung in Verkaufsräumen, Hallen, Foyers und Passagen. Als Zitat der klassischen Leuchtenform kombiniert die moderne Pendelleuchte PEARL heute hochwertige Materialität und Verarbeitung mit einer Vielzahl an Größen mit bis zu einem Meter Durchmesser. Dank der verstellbaren Stahlseilaufhängung lässt sie sich in unterschiedlichen Höhen fixieren.

The luminous sphere functions as general lighting in showrooms, halls, foyers and passages. As a replica of luminaires in the traditional form, this modern pendant, PEARL, combines high-quality materials and workmanship with a wide range of different sizes, up to one metre in diameter. Thanks to its height-adjustable steel cable suspension, it can be positioned at different heights.



PEARL





# PEARL

# PEARL

## Pendelleuchte

- › Oberfläche Baldachin chrom
- › Abdeckung PE naturweiß für homogene Ausleuchtung und hohe Stabilität
- › Werkzeuglos höhenverstellbare Stahlseilaufhängung, L 2.000 mm und L 3.000 mm
- › Lichtverteilung direkt/indirekt

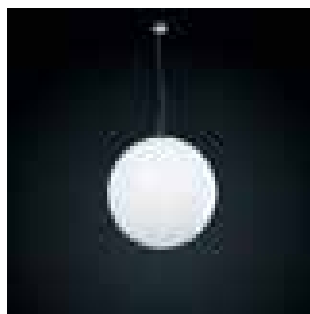
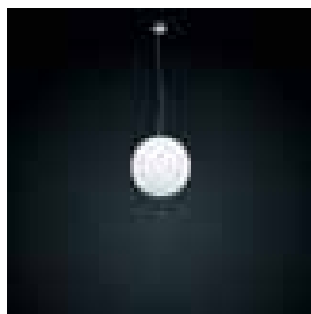

## Pendant light

- › Surface canopy chrome
- › Ball in natural white PE for uniform illumination and great stability
- › Tool-free, height-adjustable steel cable suspension
- › Direct/indirect light distribution

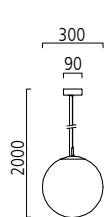
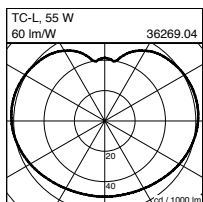

**Ø 300 x 2.000 mm**  
 1 x TC-TEL, 13 W, GX24q-1 2,1 kg  
**16265.04** ON/OFF  
**16265.041** DIM 1-10V

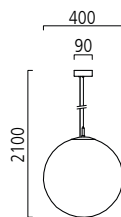

**Ø 400 x 2.100 mm**  
 1 x TC-TEL, 18 W, GX24q-2 3,8 kg  
**16266.04** ON/OFF  
**16266.041** DIM 1-10V  
**16266.042** DIM DALI

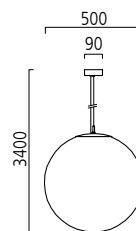

**Ø 500 x 3.400 mm**  
 2 x TC-L, 24 W, 2G11 6 kg  
**26267.04** ON/OFF  
**26267.041** DIM 1-10V  
**26267.042** DIM DALI

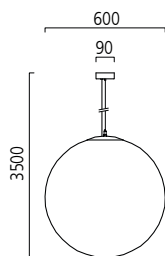

**Ø 600 x 3.500 mm**  
 2 x TC-L, 36 W, 2G11 9,3 kg  
**26268.04** ON/OFF  
**26268.041** DIM 1-10V  
**26268.042** DIM DALI

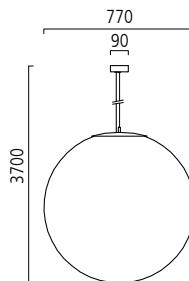

**Ø 770 x 3.700 mm**  
 3 x TC-L, 55 W, 2G11 13,8 kg  
**36269.04** ON/OFF  
**36269.041** DIM 1-10V  
**36269.042** DIM DALI

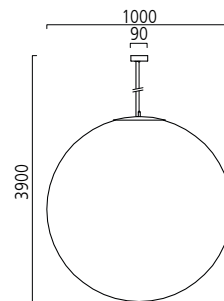

**Ø 1.000 x 3.900 mm**  
 4 x TC-L, 55 W, 2G11 29,5 kg  
**46270.04** ON/OFF  
**46270.041** DIM 1-10V  
**46270.042** DIM DALI







TURN ist die passende Wahl, wenn die funktionale Beleuchtung unter der Decke platziert werden und auch optisch einen Akzent setzen soll. Die Leuchte aus eloxiertem Aluminium und satiniertem Acryl sorgt für eine gute Lichtverteilung bei hoher Effizienz.

TURN is a suitable choice for functional lighting to be placed on the ceiling and to set a visual highlight as well. The luminaire made of anodised aluminium and satinised acrylic combines good light distribution with high efficiency.



TURN

# TURN

## Deckenleuchte

- › Abgesetzter Leuchtenkörper
- › Oberfläche Aluminium eloxiert
- › Sehr gute Raumaufhellung durch großen Abstrahlwinkel
- › Hohe Effizienz
- › Abdeckung satiniert für homogene Ausleuchtung
- › Werkzeugloser Leuchtmittelwechsel
- › Lichtverteilung direkt/indirekt
- › Notbeleuchtung auf Anfrage



## Ceiling light

- › Detached housing
- › Surface aluminium anodised
- › Very wide light distribution
- › High efficiency
- › Cover satinised for uniform illumination
- › Tool-free exchange of lamps
- › Direct/indirect light distribution
- › Emergency lighting on request

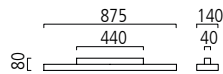
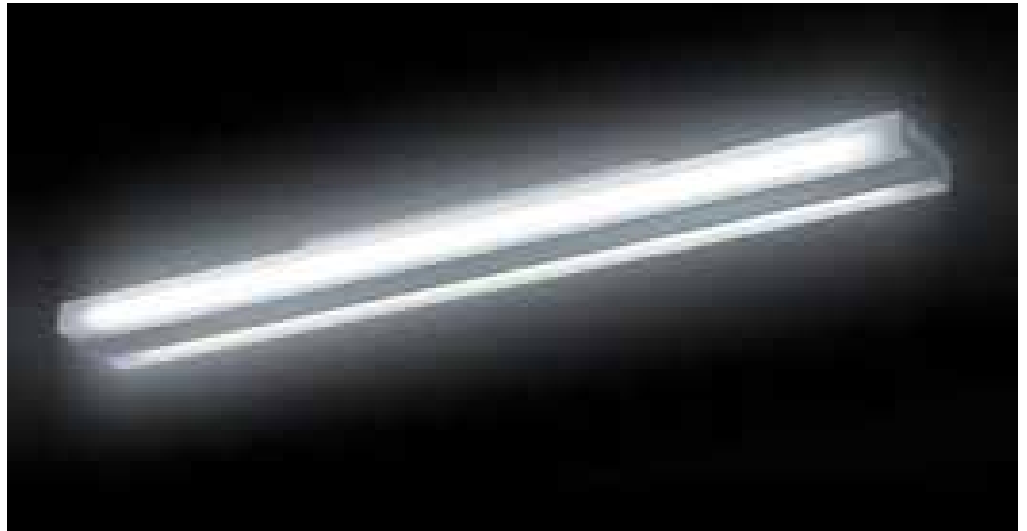

**875 x 140 x 80 mm**  
 2 x T16, 21/39 W, G5 3,8 kg  
**25879.25** ON/OFF  
**25879.251** DIM 1-10V  
**25879.252** DIM DALI

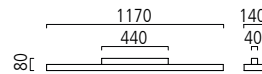

**1.170 x 140 x 80 mm**  
 2 x T16, 28/54 W, G5 4,4 kg  
**25880.25** ON/OFF  
**25880.251** DIM 1-10V  
**25880.252** DIM DALI

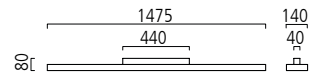

**1.475 x 140 x 80 mm**  
 2 x T16, 35/49 W, G5 5,2 kg  
**25881.25** ON/OFF  
**25881.251** DIM 1-10V  
**25881.252** DIM DALI

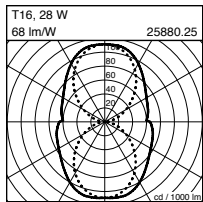





TENDO 1 ist für die lineare Architekturbeleuchtung konzipiert. Wahlweise als Pendel-, Decken- oder Wandleuchte sorgt TENDO 1 mit direkter/indirekter Lichtverteilung für eine klare, strukturierte Beleuchtung des Raumes. Die Leuchte aus eloxiertem Aluminium wird mit satinierten Acrylabdeckungen geliefert. Wand-, Decken- und Einbauleuchten anderer Systeme in ebenfalls reduziertem Design ergänzen TENDO 1.

TENDO 1 is designed for linear illumination of architecture. Available as a pendant, ceiling or wall light according to customer choice, TENDO 1 provides clear, structured lighting of interiors with direct/indirect light distribution. The body is made of anodised aluminium and comes with satinised acrylic covers. TENDO 1 can be combined with wall, ceiling and recessed lights from other systems in minimalistic design.



# TENDO 1

# TENDO 1

## Wandleuchte / Deckenleuchte

- › Abgesetzter Leuchtenkörper
- › Oberfläche Aluminium eloxiert
- › Abdeckung satiniert für homogene Ausleuchtung
- › Werkzeugloser Leuchtmittelwechsel
- › Lichtverteilung direkt/indirekt
- › Notbeleuchtung auf Anfrage



## Wall light / Ceiling light

- › Detached housing
- › Surface aluminium anodised
- › Cover up / down satinised for uniform illumination
- › Tool-free exchange of lamps
- › Direct/indirect light distribution
- › Emergency lighting on request

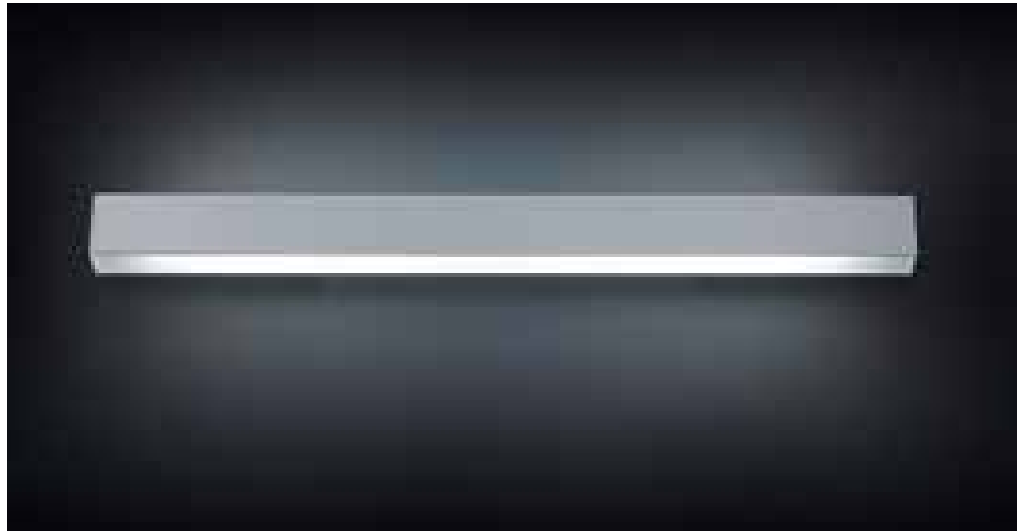

## Wandleuchte / Wall light

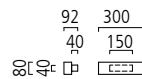

**300 x 52 x 80 mm**  
 1 x TC-L, 18 W, 2G11 1,2 kg  
**18868.25** ON/OFF



**900 x 52 x 80 mm**  
 1 x T16, 21/39 W, G5 3,3 kg  
**18870.25** ON/OFF  
**18870.251** DIM 1-10V  
**18870.252** DIM DALI

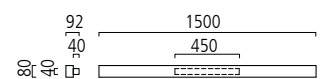

**1.500 x 52 x 80 mm**  
 1 x T16, 35/49 W, G5 4,7 kg  
**18241.25** ON/OFF  
**18241.251** DIM 1-10V  
**18241.252** DIM DALI

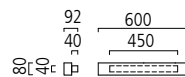
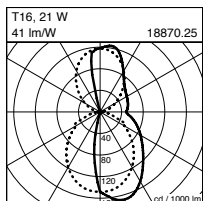
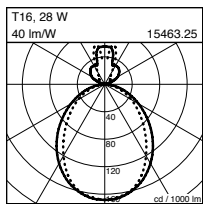

**600 x 52 x 80 mm**  
 1 x T16, 14/24 W, G5 2,6 kg  
**18869.25** ON/OFF  
**18869.251** DIM 1-10V  
**18869.252** DIM DALI

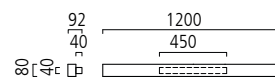

**1.200 x 52 x 80 mm**  
 1 x T16, 28/54 W, G5 3,9 kg  
**18871.25** ON/OFF  
**18871.251** DIM 1-10V  
**18871.252** DIM DALI

Das modulare TENDO 1 System finden Sie auf Seite 184.

Please find the modular TENDO 1 system on page 184.



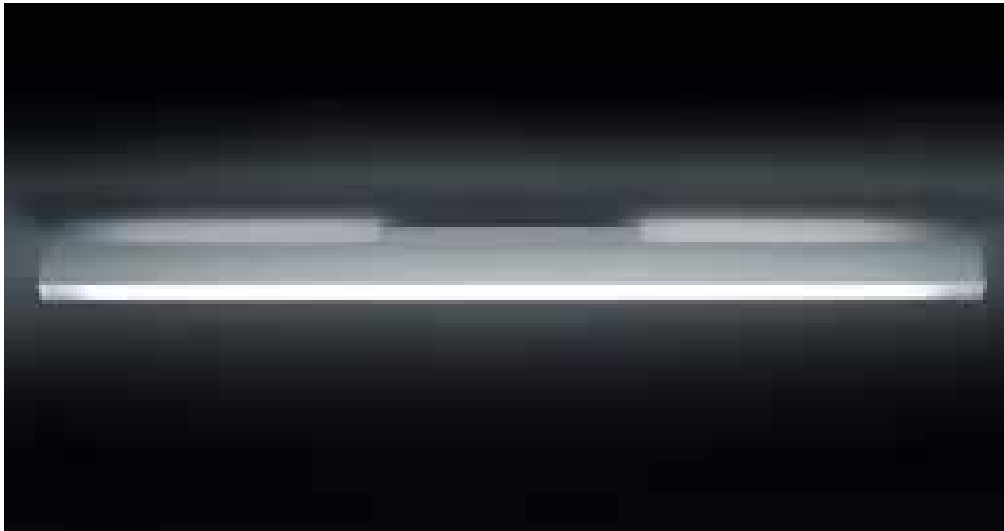

**Deckenleuchte / Ceiling light**

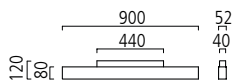

**900 x 52 x 80 mm**  
 1 x T16, 21/39 W, G5 3,6 kg  
**15462.25** ON/OFF  
**15462.251** DIM 1-10V  
**15462.252** DIM DALI

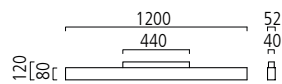

**1.200 x 52 x 80 mm**  
 1 x T16, 28/54 W, G5 4,1 kg  
**15463.25** ON/OFF  
**15463.251** DIM 1-10V  
**15463.252** DIM DALI

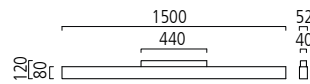

**1.500 x 52 x 80 mm**  
 1 x T16, 35/49 W, G5 4,6 kg  
**15464.25** ON/OFF  
**15464.251** DIM 1-10V  
**15464.252** DIM DALI

**Das modulare TENDO 1 System finden Sie auf Seite 184.**  
 Please find the modular TENDO 1 system on page 184.



# TENDO 1

## Pendelleuchte

- › Oberfläche Aluminium eloxiert
- › Abdeckung satiniert für homogene Ausleuchtung
- › Werkzeuglos höhenverstellbare Stahlseilaufhängung, L max. 1.500 mm
- › Werkzeugloser Leuchtmittelwechsel
- › Lichtverteilung direkt/indirekt für zusätzliche Akzentuierung an der Decke



## Pendant light

- › Surface aluminium anodised
- › Cover satinised for uniform illumination
- › Tool-free, height-adjustable steel cable suspension L 1.500 mm
- › Tool-free exchange of lamps
- › Direct/indirect light distribution for additional accentuation on ceiling

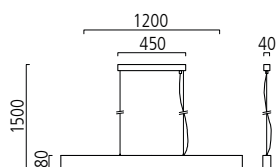

**1.200 x 52 x 80 mm**

1 x T16, 28/54 W, G5 4,2 kg

**16079.25** ON/OFF

**16079.251** DIM 1-10V

**16079.252** DIM DALI

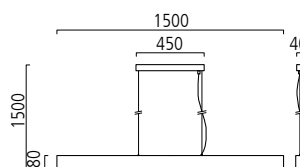

**1.500 x 52 x 80 mm**

1 x T16, 35/49 W, G5 5 kg

**16080.25** ON/OFF

**16080.251** DIM 1-10V

**16080.252** DIM DALI

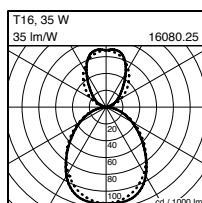

**Das modulare TENDO 1 System finden Sie auf Seite 184.**

Please find the modular TENDO 1 system on page 184.





Erste Wahl für die Beleuchtung von Bildschirmarbeitsplätzen: Durch eine spezielle Prismenoptik bringt FACTORY blendfreies Licht ins Büro – sowohl direkt auf den Arbeitsplatz als auch über den nach oben gerichteten indirekten Lichtanteil zur Deckenaufhellung. Die silbergraue Oberfläche und die Ausführung ohne sichtbare Schrauben machen die Leuchte zu einer ästhetischen Stand-Alone-Lösung. Ein Tageslicht- und Anwesenheitssensor sparen Energie, da die Leuchte bedarfsgerecht geschaltet wird. Mit dem CONNECT-Modul kann die Stehleuchte FACTORY mit benachbarten Leuchten der gleichen Leuchten-gruppe kommunizieren. So entstehen zu jeder Tages- und Jahreszeit angenehme Beleuchtungsszenarien.

The first choice for the illumination of computer workplaces: Thanks to special prismatic optics, FACTORY brings glare-free light to the office both directly onto the workplace and indirectly upwards to brighten the ceiling. Its silver-grey surface and the absence of visible screws make this luminaire an aesthetic standalone solution. A daylight and presence sensor saves energy by switching the lamp on and off automatically as needed. With the help of the CONNECT module, the FACTORY floor light is able to communicate with neighbouring luminaires of the same group. In this way, attractive illumination scenarios can be created at any time of day or season of the year.

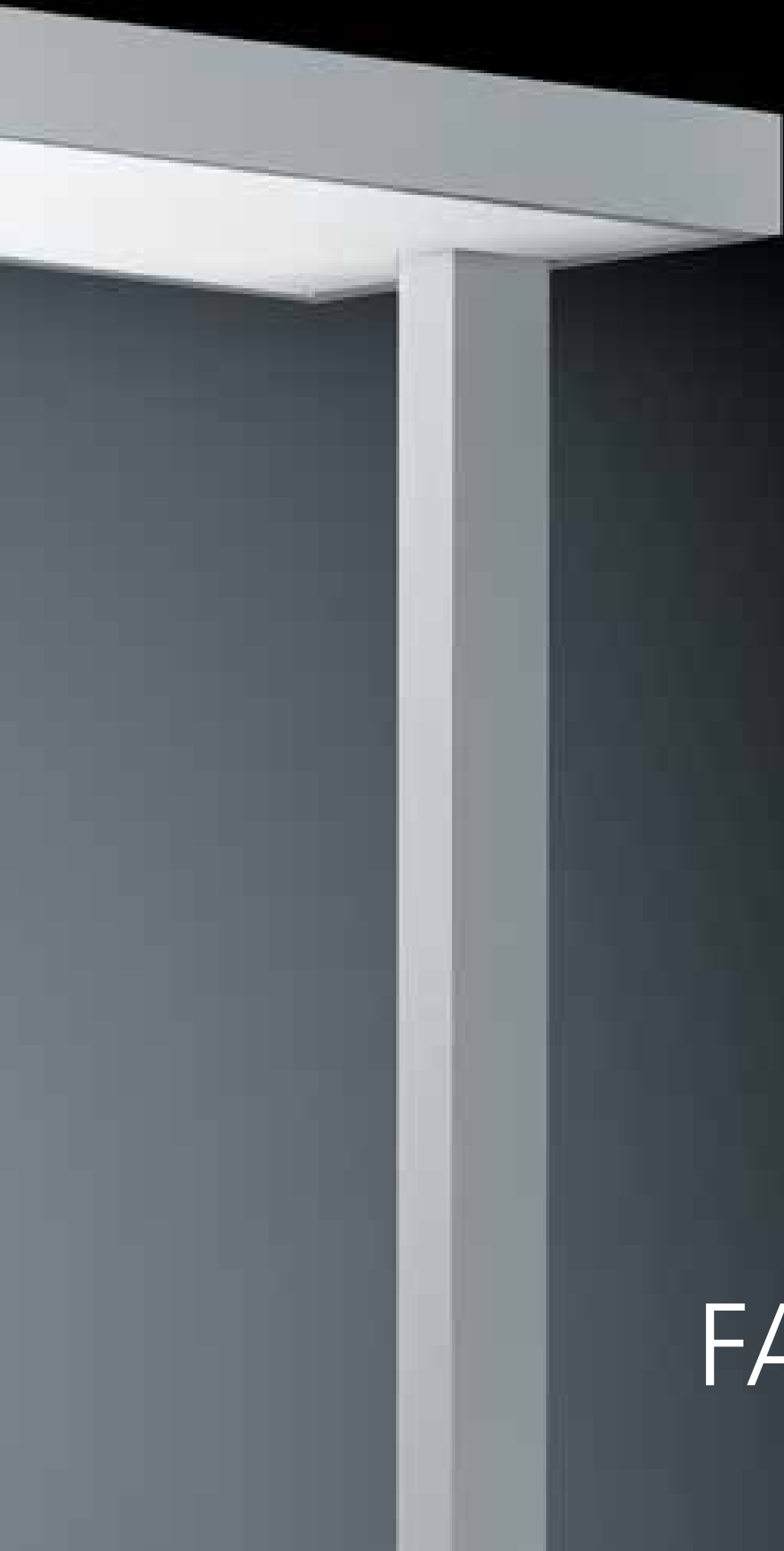

FACTORY





# FACTORY

# FACTORY

## Pendelleuchte

- › Für Bildschirmarbeitsplatzbeleuchtung
- › Blendfreies Licht durch Prismenoptik
- › Oberfläche silbergrau
- › Ohne sichtbare Schrauben
- › Abhängung werkzeuglos höhenverstellbar, L = 1.500 mm
- › Lichtverteilung direkt/indirekt für zusätzliche Deckenaufhellung
- › Obere Abdeckung als separates Zubehör



## Wandleuchte

- › Abgesetzter eckiger Leuchtenkörper
- › Oberfläche silbergrau
- › Abdeckung satiniert für homogene Ausleuchtung
- › Lichtverteilung direkt/indirekt für zusätzliche Akzentuierung an der Wand/Decke
- › Obere Abdeckung als separates Zubehör

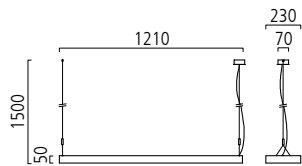

**1.210 x 230 x 50 mm**  
 2 x T16, 28/54 W, G5 5,2 kg  
**16232.46** ON/OFF  
**16232.461** DIM 1-10V  
**16232.462** DIM DALI

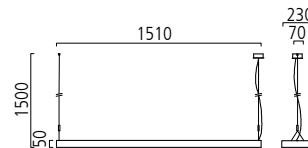

**1.510 x 230 x 50 mm**  
 2 x T16, 35/49 W, G5 6,1 kg  
**16234.46** ON/OFF  
**16234.461** DIM 1-10V  
**16234.462** DIM DALI



## Pendant light

- › Suitable for computer workstations
- › Surface silver grey
- › Prismatic diffuser for glare-free light
- › Top cover as separate accessory
- › Without visible screws
- › Tool-free, height-adjustable steel cable suspension, L 1.500 mm
- › Direct/indirect light distribution for additional ceiling lighting

## Wall light

- › Detached housing
- › Surface silver grey
- › Cover satinised for uniform illumination
- › Direct/indirect light distribution for additional accentuation on wall/ceiling
- › Top cover as separate accessory

## Zubehör / Accessories

### Glasabdeckung ESG

Glass cover  
**6604**

### Glasabdeckung ESG

Glass cover  
**4160**

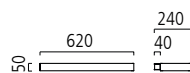
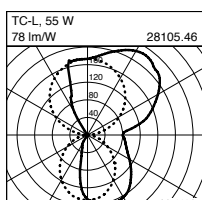
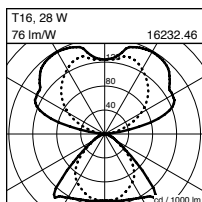

**620 x 240 x 50 mm**  
 2 x TC-L, 55 W, 2G11 3,7 kg  
**28105.46** ON/OFF

## Zubehör / Accessories

### Glasabdeckung ESG

Glass cover  
**6606**





# FACTORY | FACTORY LED

## Stehleuchte TC-L

- › Für Bildschirmarbeitsplatzbeleuchtung
- › Oberfläche silbergrau
- › Obere Abdeckung als separates Zubehör
- › Blendfreies Licht durch Prismenoptik
- › Ohne sichtbare Schrauben
- › Lichtverteilung direkt/indirekt für zusätzliche Deckenaufhellung
- › Lieferung 3-teilig

TC-L IP20

## Floor light

- › Suitable for computer workstations
- › Surface silver grey
- › Top cover as separate accessory
- › Glare-reducing prismatic diffuser
- › Without visible screws
- › Direct/indirect light distribution for additional ceiling lighting
- › Delivery in three parts

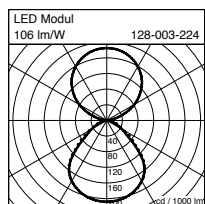
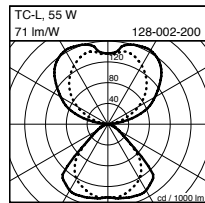
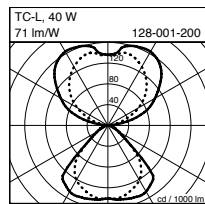

## Stehleuchte LED

- › Für Bildschirmarbeitsplatzbeleuchtung
- › Oberfläche silbergrau
- › Blendfreies Licht durch Prismenoptik
- › Ohne sichtbare Schrauben
- › Lichtverteilung direkt/indirekt für zusätzliche Deckenaufhellung
- › Energieeffiziente Low-Power-LEDs
- › Lieferung 3-teilig

LED IP20

## Floor light LED

- › Suitable for computer workstations
- › Surface silver grey
- › Glare-reducing prismatic diffuser
- › Without visible screws
- › Direct/indirect light distribution for additional ceiling lighting
- › Energy-efficient low-power LEDs
- › Delivery in three parts

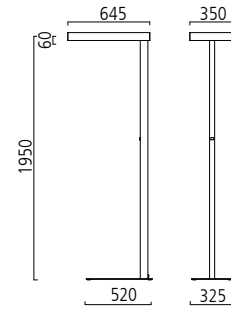

## FACTORY

4 x TC-L, 40 W, 2G11 21,0 kg  
**128-001-200** ON/OFF <sup>1)</sup>  
**128-001-220** DIM <sup>1)</sup>  
**128-001-230** DIM SENSOR <sup>1)</sup>

4 x TC-L, 55 W, 2G11 21,0 kg  
**128-002-200** ON/OFF  
**128-002-220** DIM  
**128-002-230** DIM SENSOR

## FACTORY LED

3000K, 67 W, 99 lm/W, Ra > 80 21,0 kg  
**128-003-223** DIM  
**128-003-233** DIM SENSOR <sup>2)</sup>  
**128-004-233** DIM SENSOR CONNECT <sup>2)</sup> <sup>3)</sup>

4000K, 67 W, 106 lm/W, Ra > 80 21,0 kg  
**128-003-224** DIM  
**128-003-234** DIM SENSOR <sup>2)</sup> <sup>3)</sup>  
**128-004-234** DIM SENSOR CONNECT <sup>2)</sup> <sup>3)</sup>

### ON/OFF

zweifach schaltbar / two step switch

### DIM

Dimmbar / Dimmable

### DIM SENSOR

Dimmbar + Tageslicht- und Anwesenheitssensor / Dimmable + Daylight and movement sensor

### DIM SENSOR CONNECT

Dimmbar + Tageslicht- und Anwesenheitssensor + Verknüpfung einzelner Leuchten per Funk. Gemeinsame Steuerung ganzer Leuchtengruppen. / Dimmable + Daylight and movement sensor + Wireless connection of light fixtures. Control of entire groups of luminaires.

## Zubehör nur für gekennzeichnete Leuchten

Accessories only for luminaires designated

<b>128-801-000</b>	1) Obere Abdeckung / Top Cover
<b>137-801-000</b>	2) Reflektorspiegel für erweiterten Erfassungsradius des Anwesenheitssensors Reflector for extended radius of the movement sensor
<b>128-802-000</b>	3) Programmiergerät für CONNECT Leuchten Programming unit for CONNECT luminaires





Der Name hält, was er verspricht: SPOT setzt als Lichtpunkt einen Akzent. Dabei ist das Leuchtensystem ausgesprochen vielfältig in den Ausführungsvarianten und damit auch in den Anwendungsmöglichkeiten. Mit rundem oder eckigem Gehäuse, fix oder frei dreh- und schwenkbar sowie in unterschiedlichen Wattagen dient SPOT als Grundbeleuchtung für Decken in Fluren, Büro- und Privaträumen ebenso wie für die akzentuierte Beleuchtung einzelner Gegenstände oder Flächen.

Fulfilling the promise of its name: SPOT sets a highlight with a spot of light. Yet this lighting system is highly diversified in terms of model variants and consequently application options. With round or angular housings, fixed or freely rotatable and tiltable, and laid out for different wattages, SPOT serves as general lighting in corridors, office interiors and private rooms as well as for highlighting selected objects or areas.



SPOT





SPOT

# SPOT

## Strahler

- › Für den Einbau in Hohldecken
- › Oberfläche weiß matt
- › LED Strahler 7W / 13W
- › Abstrahlwinkel 38°
- › Insektendicht
- › Inkl. Schutzglass
- › Energieeffiziente LEDs
- › LED Strahler und Einbaugehäuse bitte separat bestellen



## Spotlight

- › For hollow ceilings
- › Surface white mat
- › LED Spot 7W / 13W
- › Light beam 38°
- › Insect-proof
- › Incl. protective glass cover
- › Energy-efficient LEDs
- › Please order LED spot and housing separately



**LED Strahler inkl. Betriebsgerät, Abstrahlwinkel 38°, Ra > 80**  
LED spotlight inc.driver, beam angle 38°, Ra > 80

LED Strahler und Einbaugehäuse (Entblendungsring optional) bitte separat bestellen.

Please order LED spotlight and housing separately (anti-glare ring optional).

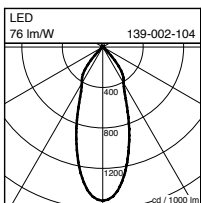
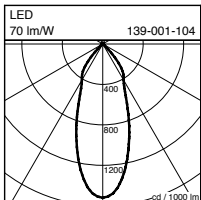

		2700K, 620 lm	3000K, 624 lm	4000K, 634 lm
7 W	ON/OFF	<b>139-001-102</b>	<b>139-001-103</b>	<b>139-001-104</b>
	DIM DALI	<b>139-001-122</b>	<b>139-001-123</b>	<b>139-001-124</b>
	Phase DIM	<b>139-001-142</b>	<b>139-001-143</b>	<b>139-001-144</b>

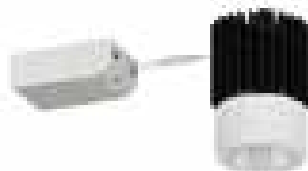

		2700K, 1138 lm	3000K, 1141 lm	4000K, 1151 lm
13 W	ON/OFF	<b>139-002-102</b>	<b>139-002-103</b>	<b>139-002-104</b>
	DIM DALI	<b>139-002-122</b>	<b>139-002-123</b>	<b>139-002-124</b>
	Phase DIM	<b>139-002-142</b>	<b>139-002-143</b>	<b>139-002-144</b>



**139-801-300** Optionaler Entblendungsring, schwarz matt für alle Strahlertypen, H 20 mm  
Optional anti-glare ring, black mat suitable for all types, H 20 mm

Durch den Einsatz des Entblendungsring erhöht sich die Einbautiefe jedes Strahlers um 20 mm.

When using the anti-glare ring the recessed depth of each spotlight requires an additional 20 mm.





# SPOT

## Einbaugehäuse / Housing



Ø 65 mm  
für Deckenstärken bis 12,5 mm  
Deckenausschnitt Ø 58 mm  
Einbautiefe 7 W, 70 mm / 13 W, 90 mm

**139-003-100**

Ø 65 mm  
for ceiling thickness of up to 12.5 mm  
Ceiling cut-out Ø 58 mm  
Installation depth 7 W, 70 mm / 13 W, 90 mm



Ø 65 mm  
mit dekorativer Glasabdeckung  
für Deckenstärken bis 12,5 mm  
Deckenausschnitt Ø 58 mm  
Einbautiefe 7 W, 70 mm / 13 W, 90 mm

**139-004-100**

Ø 65 mm  
with decorative glass cover  
for ceiling thickness of up to 12.5 mm  
Ceiling cut-out Ø 58 mm  
Installation depth 7 W, 70 mm / 13 W, 90 mm



Ø 78 mm  
dreh- und schwenkbar  
für Deckenstärken bis 20 mm  
Deckenausschnitt Ø 67 mm  
Einbautiefe 7 W, 70 mm / 13 W, 90 mm

**139-005-100**

Ø 78 mm  
rotatable and tiltable  
for ceiling thickness of up to 20 mm  
Ceiling cut-out Ø 67 mm  
Installation depth 7 W, 70 mm / 13 W, 90 mm



Ø 82 mm  
für Deckenstärken bis 30 mm  
Deckenausschnitt Ø 77 mm  
Einbautiefe 7 W, 105 mm / 13 W, 125 mm

**139-006-100**

Ø 82 mm  
for ceiling thickness of up to 30 mm  
Ceiling cut-out Ø 77 mm  
Installation depth 7 W, 105 mm / 13 W, 125 mm



Ø 88 mm  
dreh- und schwenkbar  
für Deckenstärken bis 30 mm  
Deckenausschnitt Ø 75 mm  
Einbautiefe 7 W, 95 mm / 13 W, 115 mm

**139-007-100**

Ø 88 mm  
rotatable and tiltable  
for ceiling thickness of up to 30 mm  
Ceiling cut-out Ø 75 mm  
Installation depth 7 W, 95 mm / 13 W, 115 mm



Ø 90 mm  
dreh- und schwenkbar  
für Deckenstärken bis 40 mm  
Deckenausschnitt Ø 82 mm  
Einbautiefe 7 W, 90 mm / 13 W, 110 mm  
**139-008-100**

Ø 90 mm  
rotatable and tiltable  
for ceiling thickness of up to 40 mm  
Ceiling cut-out Ø 82 mm  
Installation depth 7 W, 90 mm / 13 W, 110 mm



Ø 90 x 90 mm  
dreh- und schwenkbar  
für Deckenstärken bis 25 mm  
Deckenausschnitt Ø 82 mm  
Einbautiefe 7 W, 70 mm / 13 W, 90 mm  
**139-009-100**

Ø 90 x 90 mm  
rotatable and tiltable  
for ceiling thickness of up to 25 mm  
Ceiling cut-out Ø 82 mm  
Installation depth 7 W, 70 mm / 13 W, 90 mm



108 x 108 mm  
dreh- und schwenkbar  
für Deckenstärken bis 20 mm  
Deckenausschnitt 96 x 96 mm  
Einbautiefe 7 W, 90 mm / 13 W, 110 mm  
**139-010-100**

108 x 108 mm  
rotatable and tiltable  
for ceiling thickness of up to 20 mm  
Ceiling cut-out 96 x 96 mm  
Installation depth 7 W, 90 mm / 13 W, 110 mm



Ø 74 mm  
dreh- und schwenkbar  
für den randlosen Einbau in Gipskartondecken  
für Deckenstärken bis 20 mm  
Deckenausschnitt Ø 83 mm  
Einbautiefe 7 W, 90 mm / 13 W, 110 mm  
**139-011-100**

Ø 74 mm  
rotatable and tiltable  
for trimless installation in plasterboard ceilings  
for ceiling thickness of up to 20 mm  
Ceiling cut-out Ø 83 mm  
Recess depth 7 W, 90 mm / 13 W, 110 mm



92 x 92 mm  
dreh- und schwenkbar  
für den randlosen Einbau in Gipskartondecken  
für Deckenstärken bis 20 mm  
Deckenausschnitt 94 x 94 mm  
Einbautiefe 7 W, 90 mm / 13 W, 110 mm  
**139-012-100**

92 x 92 mm  
rotatable and tiltable  
for trimless installation in plasterboard ceilings  
for ceiling thickness of up to 20 mm  
Ceiling cut-out 94 x 94 mm  
Installation depth 7 W, 90 mm / 13 W, 110 mm



Wie eine Kamera nimmt der Strahler CAM 7 Kunstwerke, Möbel und andere ausgewählte Objekte in den Fokus. Flexibel justierbar über eine Stromschiene oder in die Decke eingelassen mit dreh- und schwenkbarer Leuchteneinheit dient CAM 7 zur bewussten Akzentuierung mit Licht. Das funktionale Design in unterschiedlichen Farben hält sich bewusst zurück.

The CAM 7 spotlight focuses on works of art, pieces of furniture and other selected objects like a camera. Flexibly adjustable via a power-track or recessed in the ceiling with a rotatable and tiltable luminaire, CAM 7 lends itself to spot-lighting. The functional design in several different colours is deliberately kept unobtrusive.



CAM 7

# CAM 7 LED

## Strahler

- › Dreh- und schwenkbar
- › Oberfläche mattweiß, silbergrau oder mattschwarz
- › Mit 3-Phasen Euro-Adapter
- › Mit doppelt entspiegelm Schutzglas
- › Inklusive Temperaturüberwachung
- › Inklusive Reflektor 24° und 44°
- › LED weiß, ca. 3000 Lumen, L90, B10
- › 5 Jahre Garantie
- › Diverse Filter, Entblendungsvorsätze, Wabenraster, dimmbare Treiber auf Anfrage



## Spotlight

- › Rotable and tiltable
- › Surface silver grey, white mat or black mat
- › With 3-phase euro adapter
- › With anti-reflective safety-glass
- › Including temperature control
- › Including 24° and 44° reflector
- › LED white, appr. 3000 lumen, L90, B10
- › 5 years warranty
- › Various filters, anti-glare frames, honey comb louvres, dimmable converters on request

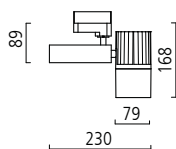

### Ø 79 x 168 mm

3000 K, 30 W, Ra>90		1,2 kg
<b>123-001-103</b>	ON/OFF	weiß / white
<b>123-001-203</b>	ON/OFF	silbergrau / silver grey
<b>123-001-303</b>	ON/OFF	schwarz / black
4000 K, 30 W, Ra>90		1,2 kg
<b>123-001-104</b>	ON/OFF	weiß / white
<b>123-001-204</b>	ON/OFF	silbergrau / silver grey
<b>123-001-304</b>	ON/OFF	schwarz / black

# CAM 7 LED

## Einbaustrahler

- › Einbaustrahler starr, dreh- und schwenkbar 24° und 44° oder asymmetrisch 44°
- › Oberfläche mattweiß
- › Mit doppelt entspiegeltem Schutzglas
- › Inklusive Temperaturüberwachung
- › LED weiß, ca. 2000 Lumen, L90, B10
- › 5 Jahre Garantie
- › Den erforderlichen Konverter bitte separat bestellen



## Recessed spotlight

- › Recessed spotlight fixed, rotatable and tiltable 24° and 44° or asymmetrical 44°
- › Surface white mat
- › With anti-reflective safety-glass
- › Including temperature control
- › LED white, appr. 2000 lumen, L90, B10
- › Energy-efficient LEDs
- › 5 years warranty
- › Please order the necessary driver separately

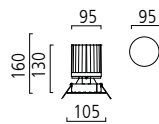

Starr  
Fixed

### Ø 105 x 130 mm

3000 K, 20 W, Ra>90 0,6 kg

**123-004-103**

4000 K, 20 W, Ra>90 0,6 kg

**123-004-104**

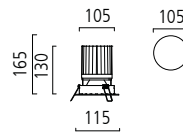

Dreh- und schwenkbar  
Rotatable and tiltable

### Ø 115 x 130 mm

3000 K, 20 W, Ra>90 0,6 kg

**123-002-103**

4000 K, 20 W, Ra>90 0,6 kg

**123-002-104**

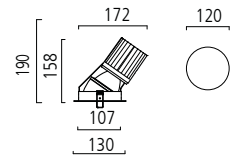

Asymmetrisch  
Asymmetric

### Ø 130 x 158 mm

3000 K, 20 W, Ra>90 0,6 kg

**123-003-103**

4000 K, 20 W, Ra>90 0,6 kg

**123-003-104**

Konverter  
Converter

**123-801-000** ON/OFF

**123-801-020** DIM DALI



Mit unserer Erfahrung aus dem Objektbereich haben wir ein Leuchtenprogramm für den niveaureichen Wohnbau entwickelt – in gewohnter Qualität von SCHMITZ und ausgestattet mit neuester Lichttechnologie. Das Konzept: Eine Auswahl an auf Grundformen basierenden Leuchten in reduzierten Dimensionen. Das minimalistische Design der Leuchten ermöglicht es, gehobene Wohnarchitektur dezent mit individuell kombinierten Leuchten auszustatten. Im Vordergrund steht dabei die perfekte Beleuchtung von Lebensräumen und die Möglichkeit, mit SCHMITZ@HOME ein durchgängiges Beleuchtungskonzept für die gesamte Architektur einzusetzen.

With our experience in architectural lighting we have developed a range of luminaires to provide residential lighting at a higher level – with the sort of quality you expect from SCHMITZ and equipped with the very latest lighting technology. The concept: a selection of luminaires based on basic shapes in reduced dimensions. The minimalist design of the luminaires makes it possible to provide refined residential architecture with suitable individually combined lights. The primary aim is thus the perfect illumination of living areas and the option to provide an integrated lighting concept throughout the architecture with SCHMITZ@HOME.





SCHMITZ@HOME

# SCHMITZ@HOME

## Wandleuchte

- › Oberfläche mattweiß oder silbergrau
- › Lichtverteilung indirekt
- › Energieeffiziente LEDs

LED IP54

## Wall light

- › Surface white mat or silver grey
- › Indirect light distribution
- › Energy-efficient LEDs



7,2 W

2 x 7,2 W

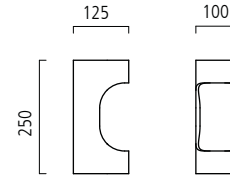
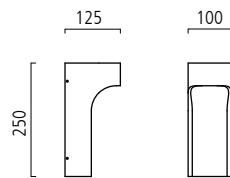

**100 x 250 x 125 mm**

3000 K, 7,2 W, 520 lm 1,6 kg

**135-007-103** ON/OFF mattweiß / white mat

**135-007-203** ON/OFF silbergrau / innen weiß  
silver grey / inside white

**100 x 250 x 125 mm**

3000 K, 2 x 7,2 W, 1040 lm 2,0 kg

**135-008-103** ON/OFF mattweiß / white mat

**135-008-203** ON/OFF silbergrau / innen weiß  
silver grey / inside white



# SCHMITZ@HOME

## Wand- und Deckenleuchte

- › Abgesetzter Leuchtenkörper
- › Oberfläche mattweiß
- › Opale lichtleitende Scheibe
- › Dimmbar, Phasen-/abschnitt
- › Seitliche Lichteinspeisung mit energieeffizienten Low-Power-LEDs

LED IP20

## Wall and ceiling light

- › Detached housing
- › Surface white mat
- › Opal, light-conducting pane
- › Dimmable, leading / trailing edge
- › Lateral light infeed with energy-efficient low-power LEDs

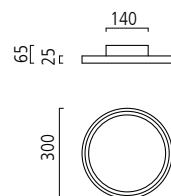

**Ø 300 x 65 mm**  
3000 K, 22 W, 1950 lm 2,5 kg  
**135-001-103** DIM PHASE

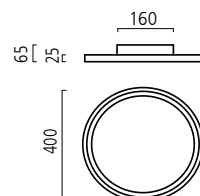

**Ø 400 x 65 mm**  
3000 K, 30 W, 2700 lm 3,5 kg  
**135-002-103** DIM PHASE

## Aufbaustrahler

- › Dreh- und schwenkbar
- › Oberfläche Aluminium, mattweiß / schwarz
- › Abstrahlwinkel 25°
- › Energieeffiziente LEDs
- › Dimmbar, Phasen-/abschnitt

LED IP20

## Surface-mounted spot

- › Rotatable and tiltable
- › Surface aluminium, white mat / black
- › Beam angle 25°
- › Energy-efficient LEDs
- › Dimmable, leading / trailing edge



**Ø 130 x 100 mm**  
3000 K, 26 W, 2340 lm 1,5 kg  
**135-020-143** DIM PHASE



# SCHMITZ@HOME

## Deckenleuchte

- › Oberfläche Aluminium matt, mattweiß, mattschwarz
- › Abstrahlwinkel 60°
- › Energieeffiziente LEDs
- › Mit prismatischer Entblendungs-scheibe

LED IP20

## Ceiling light

- › Surface aluminium mat, white mat, black mat
- › Beam angle 60°
- › Energy-efficient LEDs
- › With prismatic anti-glare plate

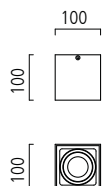

100 x 100 x 100 mm

3000 K, 15 W, 1350 lm 0,8 kg

135-009-103 ON/OFF mattweiß  
white mat

135-009-303 ON/OFF mattschwarz  
black mat

135-009-203 ON/OFF Aluminium matt  
aluminium mat

## Deckenleuchte

- › Oberfläche Aluminium matt, mattweiß, mattschwarz
- › Energieeffiziente LEDs
- › Mit satinierter Diffusorscheibe

LED IP30

## Ceiling light

- › Surface aluminium mat, white mat, black mat
- › Energy-efficient LEDs
- › With satinised diffuser plate

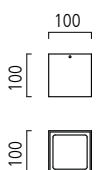

100 x 100 x 100 mm

3000 K, 15 W, 1350 lm 0,8 kg

135-010-103 ON/OFF mattweiß  
white mat

135-010-303 ON/OFF mattschwarz  
black mat

135-010-203 ON/OFF Aluminium matt  
aluminium mat

### Deckenleuchte

- › Oberfläche Aluminium matt, mattweiß, mattschwarz
- › Abstrahlwinkel 40°
- › Energieeffiziente Hochvolt-LEDs

LED IP40

### Ceiling light

- › Surface aluminium mat, white mat, black mat
- › Beam angle 40°
- › Energy-efficient high-voltage LEDs

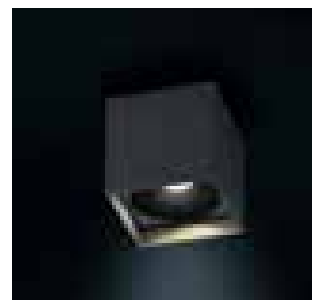

80 x 80 x 80 mm

3000 K, 4 W, 300 lm 0,5 kg

135-011-103 ON/OFF mattweiß  
white mat

135-011-303 ON/OFF mattschwarz  
black mat

135-011-203 ON/OFF Aluminium matt  
aluminium mat

### Deckenleuchte

- › Oberfläche Aluminium matt, mattweiß, mattschwarz
- › Abstrahlwinkel 40°
- › Energieeffiziente Hochvolt-LEDs

LED IP40

### Ceiling light

- › Surface aluminium mat, white mat, black mat
- › Beam angle 40°
- › Energy-efficient high-voltage LEDs

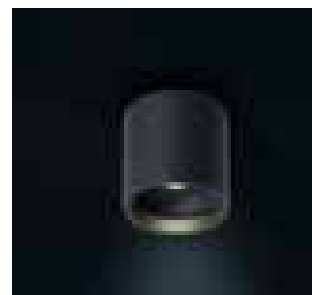

Ø 80 x 80 mm

3000 K, 4 W, 300 lm 0,5 kg

135-012-103 ON/OFF mattweiß  
white mat

135-012-303 ON/OFF mattschwarz  
black mat

135-012-203 ON/OFF Aluminium matt  
aluminium mat

# SCHMITZ@HOME

## Deckenleuchte

- › Oberfläche Aluminium matt oder mattweiß
- › Mit satiniertem Glasring
- › Dimmbar, Phasen-/abschnitt
- › Abstrahlwinkel 40°
- › Energieeffiziente Hochvolt-LEDs

LED IP44



Ø 65 x 55 mm

2800 K, 5 W, 310 lm 0,4 kg

135-013-102 DIM PHASE mattweiß  
white mat

135-013-202 DIM PHASE Aluminium matt  
aluminium mat

## Ceiling light

- › Surface aluminium matt or white mat
- › With satinised glass ring
- › Dimmable, leading / trailing edge
- › Beam angle 40°
- › Energy-efficient high-voltage LEDs



65 x 65 x 55 mm

2800 K, 5 W, 310 lm 0,4 kg

135-014-102 DIM PHASE mattweiß  
white mat

135-014-202 DIM PHASE Aluminium matt  
aluminium mat

## Pendelleuchte

- › Oberfläche Aluminium matt oder mattweiß
- › Abstrahlwinkel 28°
- › Energieeffiziente LEDs

LED IP20

## Pendant light

- › Surface aluminium matt or white mat
- › Beam angle 28°
- › Energy-efficient LEDs

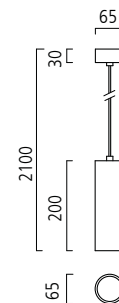

Ø 65 mm x 200 mm

2800 K, 7 W, 680 lm 0,6 kg

135-018-102 ON/OFF  
mattweiß, Textilkabel rot  
white mat, textile cable red

135-019-102 ON/OFF  
mattweiß, Textilkabel schwarz  
white mat, textile cable black

135-017-202 ON/OFF  
Aluminium matt, Kabel transparent  
aluminium mat, cable transparent

135-021-202 ON/OFF  
Aluminium matt, Textilkabel schwarz  
aluminium mat, textile cable black





# ONNO LED

## Wandleuchte

- › Oberfläche mattweiß oder Aluminium poliert
- › Lichtverteilung direkt/indirekt für zusätzliche Akzentuierung an der Wand
- › Energieeffiziente LEDs



## Wall light

- › Surface aluminium polished or white mat
- › Direct/indirect light distribution for additional accentuation on wall
- › Energy-efficient LEDs



LED, 6 W, 3000 K, 400 Lumen 1,0 kg  
**18255.07** mattweiß  
mat white



LED, 6 W, 3000 K, 400 Lumen 1,0 kg  
**18255.25** Aluminium poliert  
Aluminium polished

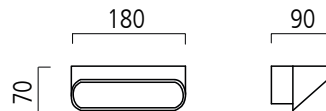





Ein multifunktionales Lichtsystem für die ebenso differenzierte wie geradlinige Architekturbeleuchtung. Mit nur 40 mm Breite ist das SYSTEM 40 | 40+ sehr filigran und bietet durch die Kombination unterschiedlicher Systemkomponenten die Möglichkeit, Aufbauleuchten, Pendelleuchten sowie Einbauleuchten für Gipskartondecken und -wände zu konfigurieren. Eine sehr elegante und gestalterisch reduzierte Lösung stellt der randlose Einbau im Gipseinbaukanal dar. Unterschiedliche LED-Leuchteinheiten mit opalen Optiken oder Prismenoptiken bieten bedarfsgerechte und energieeffiziente Optionen. Für besondere Beleuchtungssituationen, beispielsweise in Verkaufsräumen, stehen asymmetrisch abstrahlende Optiken für Wallwasher-Effekte zur Verfügung.

A multi-functional lighting system for differentiated, yet straight-forward illumination of architecture. With a width of no more than 40 mm, the SYSTEM 40 | 40+ is extremely slender and offers the option of combining different system elements into surface-mounted lights, pendant lights or recessed lights in plasterboard ceilings and walls. A very elegant, minimalistic solution is created by seamless installation in a gypsum channel. Various LED lighting units with an opal or prismatic look offer a choice of energy-efficient options to meet every need. For special lighting needs such as in showrooms, asymmetric models to produce wall washer effects are also available.



SYSTEM 40 | 40 +





SYSTEM 40 | 40 +

# SYSTEM 40 | 40 +

- › System als Aufbauleuchte / Pendelleuchte / Einbauleuchte in Gipsdecken und -wände oder rahmenlos im Gipseinbaukanal
- › Aluminiumprofile silbergrau oder weiß (auch als 90°-Winkel)
- › Passgenaue LED-Leuchteneinheiten in unterschiedlichen Längen mit den Optiken PUBLIC, OFFICE, WALLWASH
- › Werkzeuglose Montage der Leuchteneinheiten im Aluminiumprofil
- › Passgenauer Gipseinbaukanal in unterschiedlichen Höhen (auch als 90°-Winkel)
- › Lichtverteilung direkt, System 40
- › Lichtverteilung direkt/indirekt, System 40 +
- › Energieeffiziente Low-Power-LEDs
- ›  XXX-E01 = Leuchte mit Notlicht (Batterie 3h), weitere Notlichtvarianten auf Anfrage möglich

LED IP30

- › System elements as surface-mounted, pendant or recessed lights in plasterboard ceilings and walls or frameless recessed installation in gypsum channels
- › Aluminium profiles silver grey or white (also as a 90° angle)
- › Matching LED lighting units in different lengths with optics PUBLIC, OFFICE, WALLWASH
- › Tool-free assembly of lighting units in aluminium profile
- › Gypsum installation channels (also as a 90° angle)
- › Direct light distribution, System 40
- › Direct/indirect light distribution, System 40 +
- › Energy-efficient low-power LEDs
- › XXX-E01 = lamp with emergency light  (battery 3H), other emergency light variants available on request





**SYSTEM 40**  
**PUBLIC mit opaler Optik**  
**OFFICE mit Prismenoptik**  
**WALLWASH mit asymmetrischer**  
**Lichtverteilung**

PUBLIC with opal optics  
OFFICE with prismatic optics  
WALLWASH with asymmetric  
light distribution

Aufbauleuchte  
surface-mounted light

Pendelleuchte  
pendant light

Einbauleuchte rahmenlos  
im Gipseinbaukanal  
frameless recessed light in gypsum  
channel

Einbauleuchte mit Einbaurahmen für  
Gipsdecken und -wände  
Recessed light with installation frame  
for plasterboard ceilings and walls

**SYSTEM 40 +**  
**PUBLIC mit opaler Optik**  
**PUBLIC with opal optics**

Aufbauleuchte  
surface-mounted light

Pendelleuchte  
pendant light

Einbauleuchte rahmenlos  
im Gipseinbaukanal  
frameless recessed light in gypsum  
channel

Einbauleuchte mit Einbaurahmen für  
Gipsdecken und -wände  
Recessed light with installation frame  
for plasterboard ceilings and walls





# SYSTEM 40 | 40+

**Leuchteneinheit LED mit 5 poliger Durchgangsverdrahtung (inklusive PUBLIC, OFFICE oder WALLWASH Optik)**  
 Lighting unit LED with 5 pole electrical connection (including PUBLIC, OFFICE or WALLWASH Optics)





**SYSTEM 40**  
**Leuchteneinheit PUBLIC mit opaler Optik**  
 Lighting unit PUBLIC with opal optics

LED Leistung ca. / LED power appr. 2400 lm / m

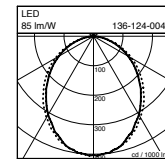
		3000 K			4000 K		
L	W	lm /W	ON/OFF	DIM DALI	lm /W	ON /OFF	DIM DALI
844 mm	16	78	<b>136-121-003</b>	<b>136-121-023</b>	80	<b>136-121-004</b>	<b>136-121-024</b>
984 mm	18	80	<b>136-122-003</b>	<b>136-122-023</b>	83	<b>136-122-004</b>	<b>136-122-024</b>
1.124 mm	20	83	<b>136-123-003</b>	<b>136-123-023</b>	85	<b>136-123-004</b>	<b>136-123-024</b>
 1.404 mm	25	83	<b>136-124-003</b>	<b>136-124-023</b>	85	<b>136-124-004</b>	<b>136-124-024</b>
 1.685 mm	29	86	<b>136-125-003</b>	<b>136-125-023</b>	88	<b>136-125-004</b>	<b>136-125-024</b>
(90°) 590 x 590 mm	20	83	<b>136-126-003</b>	<b>136-126-023</b>	85	<b>136-126-004</b>	<b>136-126-024</b>



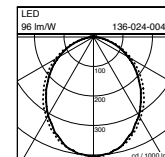

LED Leistung ca. / LED power appr. 3700 lm / m

		3000 K			4000 K			Tunable white 3000-6000 K
L	W	lm /W	ON/OFF	DIM DALI	lm /W	ON /OFF	DIM DALI	DIM DALI
844 mm	21	90	<b>136-021-003</b>	<b>136-021-023</b>	94	<b>136-021-004</b>	<b>136-021-024</b>	<b>136-021-029*</b>
984 mm	25	88	<b>136-022-003</b>	<b>136-022-023</b>	92	<b>136-022-004</b>	<b>136-022-024</b>	
1.124 mm	28	90	<b>136-023-003</b>	<b>136-023-023</b>	94	<b>136-023-004</b>	<b>136-023-024</b>	<b>136-023-029*</b>
 1.404 mm	34	93	<b>136-024-003</b>	<b>136-024-023</b>	96	<b>136-024-004</b>	<b>136-024-024</b>	<b>136-024-029*</b>
 1.685 mm	41	92	<b>136-025-003</b>	<b>136-025-023</b>	96	<b>136-025-004</b>	<b>136-025-024</b>	
(90°) 590 x 590 mm	28	90	<b>136-026-003</b>	<b>136-026-023</b>	94	<b>136-026-004</b>	<b>136-026-024</b>	<b>136-026-029*</b>





**SYSTEM 40**  
**Leuchteneinheit OFFICE mit Prismenoptik**  
 Lighting unit OFFICE with prismatic optics

LED Leistung ca. / LED power appr. 2400 lm / m

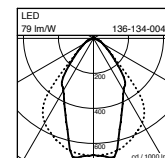
		3000 K			4000 K		
L	W	lm /W	ON/OFF	DIM DALI	lm /W	ON /OFF	DIM DALI
844 mm	16	72	<b>136-131-003</b>	<b>136-131-023</b>	74	<b>136-131-004</b>	<b>136-131-024</b>
984 mm	18	75	<b>136-132-003</b>	<b>136-132-023</b>	77	<b>136-132-004</b>	<b>136-132-024</b>
1.124 mm	20	77	<b>136-133-003</b>	<b>136-133-023</b>	79	<b>136-133-004</b>	<b>136-133-024</b>
 1.404 mm	25	77	<b>136-134-003</b>	<b>136-134-023</b>	79	<b>136-134-004</b>	<b>136-134-024</b>
 1.685 mm	29	79	<b>136-135-003</b>	<b>136-135-023</b>	82	<b>136-135-004</b>	<b>136-135-024</b>
(90°) 590 x 590 mm	20	77	<b>136-136-003</b>	<b>136-136-023</b>	79	<b>136-136-004</b>	<b>136-136-024</b>



LED Leistung ca. / LED power appr. 3700 lm / m

		3000 K			4000 K			Tunable white 3000-6000 K
L	W	lm /W	ON/OFF	DIM DALI	lm /W	ON /OFF	DIM DALI	DIM DALI
844 mm	21	84	<b>136-031-003</b>	<b>136-031-023</b>	87	<b>136-031-004</b>	<b>136-031-024</b>	<b>136-031-029*</b>
984 mm	25	82	<b>136-032-003</b>	<b>136-032-023</b>	85	<b>136-032-004</b>	<b>136-032-024</b>	
1.124 mm	28	84	<b>136-033-003</b>	<b>136-033-023</b>	87	<b>136-033-004</b>	<b>136-033-024</b>	<b>136-033-029*</b>
 1.404 mm	34	86	<b>136-034-003</b>	<b>136-034-023</b>	90	<b>136-034-004</b>	<b>136-034-024</b>	<b>136-034-029*</b>
 1.685 mm	41	86	<b>136-035-003</b>	<b>136-035-023</b>	89	<b>136-035-004</b>	<b>136-035-024</b>	
(90°) 590 x 590 mm	28	84	<b>136-036-003</b>	<b>136-036-023</b>	87	<b>136-036-004</b>	<b>136-036-024</b>	<b>136-036-029*</b>

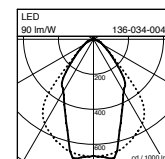

- XXX-E01 = Leuchte mit Notlicht (Batterie 3h), weitere Notlichtvarianten auf Anfrage möglich  
XXX-E01 = lamp with emergency light (battery 3H), other emergency light variants available on request
- \* DALI DT8 (Device Type 8) erforderlich / required



**SYSTEM 40**  
Leuchteneinheit WALLWASH mit asymmetrischer Lichtverteilung  
Lighting unit WALLWASH with asymmetric light distribution

LED Leistung ca. / LED power appr. 2400 lm / m

		3000 K			4000 K		
L	W	lm /W	ON/OFF	DIM DALI	lm /W	ON /OFF	DIM DALI
844 mm	16	84	<b>136-141-003</b>	<b>136-141-023</b>	87	<b>136-141-004</b>	<b>136-141-024</b>
984 mm	18	87	<b>136-142-003</b>	<b>136-142-023</b>	90	<b>136-142-004</b>	<b>136-142-024</b>
1.124 mm	20	90	<b>136-143-003</b>	<b>136-143-023</b>	92	<b>136-143-004</b>	<b>136-143-024</b>
1.404 mm	25	90	<b>136-144-003</b>	<b>136-144-023</b>	92	<b>136-144-004</b>	<b>136-144-024</b>
1.685 mm	29	93	<b>136-145-003</b>	<b>136-145-023</b>	96	<b>136-145-004</b>	<b>136-145-024</b>
(90°) 590 x 590 mm	20	90	<b>136-146-003</b>	<b>136-146-023</b>	92	<b>136-146-004</b>	<b>136-146-024</b>

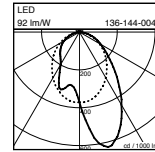

LED Leistung ca. / LED power appr. 3700 lm / m

		3000 K			4000 K			Tunable white 3000-6000 K
L	W	lm /W	ON/OFF	DIM DALI	lm /W	ON /OFF	DIM DALI	DIM DALI
844 mm	21	98	<b>136-041-003</b>	<b>136-041-023</b>	102	<b>136-041-004</b>	<b>136-041-024</b>	<b>136-041-029*</b>
984 mm	25	96	<b>136-042-003</b>	<b>136-042-023</b>	100	<b>136-042-004</b>	<b>136-042-024</b>	
1.124 mm	28	98	<b>136-043-003</b>	<b>136-043-023</b>	102	<b>136-043-004</b>	<b>136-043-024</b>	<b>136-043-029*</b>
1.404 mm	34	100	<b>136-044-003</b>	<b>136-044-023</b>	105	<b>136-044-004</b>	<b>136-044-024</b>	<b>136-044-029*</b>
1.685 mm	41	100	<b>136-045-003</b>	<b>136-045-023</b>	104	<b>136-045-004</b>	<b>136-045-024</b>	
(90°) 590 x 590 mm	28	98	<b>136-046-003</b>	<b>136-046-023</b>	102	<b>136-046-004</b>	<b>136-046-024</b>	<b>136-046-029*</b>

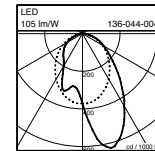

**SYSTEM 40 +**  
Leuchteneinheit PUBLIC mit opaler Optik  
Lighting unit PUBLIC with opal optics

LED Leistung ca. / LED power appr. 2400 lm / m

		3000 K			4000 K		
L	W	lm /W	ON/OFF	DIM DALI	lm /W	ON /OFF	DIM DALI
844 mm	16	102	<b>136-151-003</b>	<b>136-151-023</b>	105	<b>136-151-004</b>	<b>136-151-024</b>
984 mm	18	106	<b>136-152-003</b>	<b>136-152-023</b>	109	<b>136-152-004</b>	<b>136-152-024</b>
1.124 mm	20	109	<b>136-153-003</b>	<b>136-153-023</b>	113	<b>136-153-004</b>	<b>136-153-024</b>
1.404 mm	22	109	<b>136-154-003</b>	<b>136-154-023</b>	113	<b>136-154-004</b>	<b>136-154-024</b>
1.685 mm	29	113	<b>136-155-003</b>	<b>136-155-023</b>	116	<b>136-155-004</b>	<b>136-155-024</b>
(90°) 590 x 590 mm	20	109	<b>136-156-003</b>	<b>136-156-023</b>	113	<b>136-156-004</b>	<b>136-156-024</b>

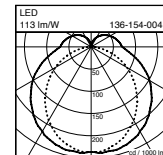

LED Leistung ca. / LED power appr. 3700 lm / m

		3000 K			4000 K			Tunable white 3000-6000 K
L	W	lm /W	ON/OFF	DIM DALI	lm /W	ON /OFF	DIM DALI	DIM DALI
844 mm	21	119	<b>136-051-003</b>	<b>136-051-023</b>	124	<b>136-051-004</b>	<b>136-051-024</b>	<b>136-051-029*</b>
984 mm	25	116	<b>136-052-003</b>	<b>136-052-023</b>	121	<b>136-052-004</b>	<b>136-052-024</b>	
1.124 mm	28	119	<b>136-053-003</b>	<b>136-053-023</b>	124	<b>136-053-004</b>	<b>136-053-024</b>	<b>136-053-029*</b>
1.404 mm	34	122	<b>136-054-003</b>	<b>136-054-023</b>	127	<b>136-054-004</b>	<b>136-054-024</b>	<b>136-054-029*</b>
1.685 mm	41	122	<b>136-055-003</b>	<b>136-055-023</b>	127	<b>136-055-004</b>	<b>136-055-024</b>	
(90°) 590 x 590 mm	28	119	<b>136-056-003</b>	<b>136-056-023</b>	124	<b>136-056-004</b>	<b>136-056-024</b>	<b>136-056-029*</b>

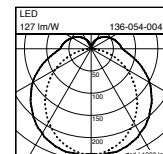

# SYSTEM 40 | 40 +

## Schnellrechentabelle / Easy planning guide

### 3000 K und 4000 K

Systemlänge ohne Enddeckel System length without end caps	Anzahl der LED-Leuchteinheiten Number of LED lighting units				
	844 mm	984 mm	1.124 mm	1.404 mm	1.685 mm
844 mm	1				
984 mm		1			
1.124 mm			1		
1.404 mm				1	
1.685 mm					1
1.828 mm	1	1			
1.968 mm	1		1		
2.108 mm		1	1		
2.248 mm			2		
2.388 mm		1		1	
2.528 mm			1	1	
2.669 mm		1			1
2.808 mm				2	
2.952 mm	1	1	1		
3.089 mm				1	1
3.232 mm		1	2		
3.370 mm					2
3.512 mm		1	1	1	
3.653 mm	1		1		1
3.792 mm		1		2	
3.933 mm			2		1
4.073 mm		1		1	1
4.213 mm			1	1	1
4.354 mm		1			2
4.493 mm				2	1
4.637 mm	1	1	1		1
4.774 mm				1	2
4.917 mm		1	2		1
5.055 mm					3
5.197 mm		1	1	1	1
5.338 mm	1		1		2
5.477 mm		1		2	1
5.618 mm			2		2

### 3000 K und 4000 K

Systemlänge ohne Enddeckel System length without end caps	Anzahl der LED-Leuchteinheiten Number of LED lighting units				
	844 mm	984 mm	1.124 mm	1.404 mm	1.685 mm
5.758 mm		1		1	2
5.898 mm			1	1	2
6.039 mm		1			3
6.178 mm				2	2
6.322 mm	1	1	1		2
6.459 mm				1	3
6.602 mm		1	2		2
6.740 mm					4
6.882 mm		1	1	1	2
7.023 mm	1		1		3
7.162 mm		1		2	2
7.303 mm			2		3
7.443 mm		1		1	3
7.583 mm			1	1	3
7.724 mm		1			4
7.863 mm				2	3
8.007 mm	1	1	1		3
8.144 mm				1	4
8.287 mm		1	2		3
8.425 mm					5
8.567 mm		1	1	1	3
8.708 mm	1		1		4
8.847 mm		1		2	3
8.988 mm			2		4
9.128 mm		1		1	4
9.268 mm			1	1	4
9.409 mm		1			5
9.548 mm				2	4
9.692 mm	1	1	1		4
9.829 mm				1	5
9.972 mm		1	2		4
10.110 mm					6

### Tunable White

Systemlänge ohne Enddeckel System length without end caps	Anzahl der LED- Leuchteinheiten Number of LED lighting units		
	844 mm	1.124 mm	1.404 mm
844 mm	1		
1.124 mm		1	
1.404 mm			1
1.688 mm	2		
1.968 mm	1	1	
2.248 mm	1		1
2.528 mm		1	1
2.808 mm			2
3.092 mm	1	2	
3.372 mm		3	
3.652 mm		2	1
3.932 mm		1	2
4.212 mm			3
4.496 mm	1	2	1
4.776 mm		3	1
5.056 mm		2	2
5.336 mm		1	3
5.616 mm			4
5.900 mm	1	2	2
6.180 mm		3	2
6.460 mm		2	3
6.740 mm		1	4
7.020 mm			5
7.304 mm	1	2	3
7.584 mm		3	3
7.864 mm		2	4
8.144 mm		1	5
8.424 mm			6
8.708 mm		4	3
8.988 mm		3	4
9.268 mm		2	5
9.548 mm		1	6
9.828 mm			7



SYSTEM 40 Pendelleuchte, weiß  
SYSTEM 40 pendant light, white



SYSTEM 40 Pendelleuchte, silbergrau  
SYSTEM 40 pendant light, silver grey

# SYSTEM 40

## System als Aufbauleuchte / Pendelleuchte / Einbauleuchte oder rahmenlos im Gips- einbaukanal

- › Passgenaue LED-Leuchten-  
einheiten inklusive der  
Abdeckungen PUBLIC, OFFICE  
oder WALLWASH separat  
bestellen (S. 174/175)
- › System endlos verlängerbar

## System elements as surface- mounted, pendant or frame- less recessed installation in gypsum channels

- › Please order matching LED ligh-  
ting units separately, including  
PUBLIC, OFFICE or WALLWASH  
covers (p. 174/175)
- › Indefinitely extensible system

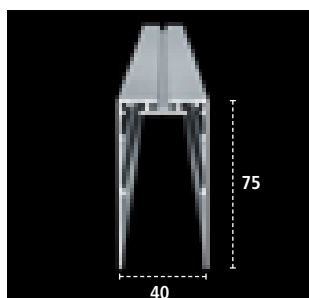

**Aluminiumprofil (L max. 3.000 mm)**  
Aluminium profile (L max. 3.000 mm)  
silbergrau / silver grey  
**136-001-200-xxxx (mm)**  
weiß / white  
**136-001-100-xxxx (mm)**

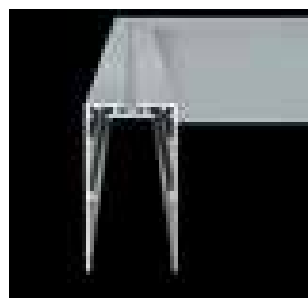

**Aluminiumprofil 90°**  
Aluminium profile 90°  
silbergrau / silver grey  
**136-005-200** 590 x 590 mm  
weiß / white  
**136-005-100** 590 x 590 mm



**2 Enddeckel für Aufbauleuchte / Pendel-  
leuchte / Einbauleuchte im Gipskanal**  
2 end caps for surface-mounted light /  
pendant light / recessed light in gypsum  
channel  
silbergrau / silver grey  
**136-801-200** 75 x 40 x 5 mm  
weiß / white  
**136-801-100** 75 x 40 x 5 mm

**Bitte Bestellhinweis auf Seite 183 beachten.**  
Please note ordering information on page 183.



Einbauleuchte rahmenlos im Gipseinbaukanal  
Frameless recessed light in gypsum channel



### Optionales Zubehör für Wandleuchte Optional accessories for wall light

**Wandbefestigung (alle 1,5 m)**  
Wall mount (every 1.5 m)

weiß / white

136-802-100

silbergrau / silver grey

136-802-200

### Optionales Zubehör für Pendelleuchte Optional accessories for pendant light

**Stahlseilaufhängung**  
L max. 3.000 mm kürzbar, (alle 1,5 m)  
Steel cable suspension  
L max. 3.000 mm shortable, (every 1.5 m)

weiß / white

136-803-100

silbergrau / silver grey

136-803-200

**Kabeleinspeisung inkl. Baldachin und Stahlseil (L 3.000 mm kürzbar)**  
Cable feeder incl. canopy and steel cable (L 3.000 mm shortable)

weiß / white

136-804-100 3-polig, 3-pole (3 x 0,75 mm<sup>2</sup>)

136-807-100 5-polig, 5-pole (5 x 0,75 mm<sup>2</sup>)

silbergrau / silver grey

136-804-200 3-polig, 3-pole (3 x 0,75 mm<sup>2</sup>)

136-807-200 5-polig, 5-pole (5 x 0,75 mm<sup>2</sup>)

**Blindabdeckung (L max. 3.000 mm)**  
Aluminium

Blank element (L max. 3.000 mm)  
Aluminium

weiß / white

136-810-100-xxxx (mm)

silbergrau / silver grey

136-810-200-xxxx (mm)

**Bitte Bestellhinweis auf Seite 183 beachten.**  
Please note ordering information on page 183.

### Zubehör für Einbauleuchte rahmenlos im Gipseinbaukanal Accessories for frameless recessed light in gypsum channel

**Demontagewerkzeug** für im Aluminiumprofil eingebaute Leuchteneinheiten  
Dismantling tool for lighting units installed in aluminium profiles  
136-808-000

**Einbaukanal aus Gips**  
Gypsum installation channel  
136-010-000 L 2.000 mm 11,6 kg

**Einbaukanal aus Gips 90°**  
Gypsum installation channel 90°  
136-012-000 L 1.000 x 1.000 m 11,6 kg

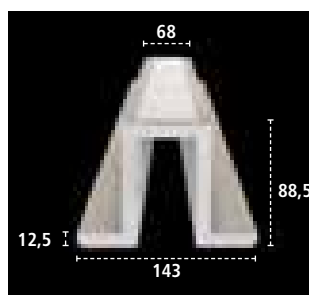

# SYSTEM 40 +

## System als Aufbauleuchte / Pendelleuchte / Einbauleuchte oder rahmenlos im Gipsein- baukanal

- › Passgenaue LED-Leuchten-  
einheiten inklusive der  
Abdeckung PUBLIC separat  
bestellen (S. 174/175)
- › System endlos verlängerbar

## System elements as surface- mounted, pendant or frame- less recessed installation in gypsum channels

- › Please order matching LED  
lighting units separately, inclu-  
ding PUBLIC cover (p. 174/175)
- › Indefinitely extensible system

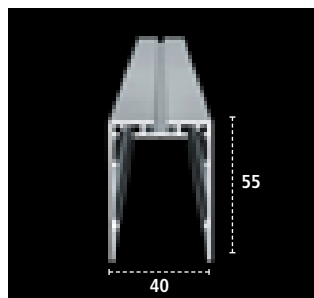

**Aluminiumprofil (L max. 3.000 mm)**  
Aluminium profile (L max. 3.000 mm)  
silbergrau / silver grey  
**136-002-200-xxxx (mm)**  
weiß / white  
**136-002-100-xxxx (mm)**



**Aluminiumprofil 90°**  
Aluminium profile 90°  
silbergrau / silver grey  
**136-006-200** 590 x 590 mm  
weiß / white  
**136-006-100** 590 x 590 mm



**2 Enddeckel für Aufbauleuchte / Pendel-  
leuchte / Einbauleuchte im Gipskanal**  
2 end caps for surface-mounted light  
/ pendant light / recessed light in  
gypsum channel  
silbergrau / silver grey  
**136-809-200** 75 x 40 x 5 mm  
weiß / white  
**136-809-100** 75 x 40 x 5 mm

**Bitte Bestellhinweis auf Seite 183 beachten.**  
Please note ordering information on page 183.





Einbauleuchte rahmenlos im Gipseinbaukanal  
Frameless recessed light in gypsum channel



### Optionales Zubehör für Wandleuchte Optional accessories for wall light

**Wandbefestigung (alle 1,5 m)**  
Wall mount (every 1.5 m)

weiß / white

**136-802-100**

silbergrau / silver grey

**136-802-200**

### Optionales Zubehör für Pendelleuchte Optional accessories for pendant light

**Stahlseilaufhängung**  
L max. 3.000 mm kürzbar, (alle 1,5 m)  
Steel cable suspension  
L max. 3.000 mm shortable, (every 1.5 m)  
weiß / white

**136-803-100**

silbergrau / silver grey

**136-803-200**

**Kabeleinspeisung inkl. Baldachin und Stahlseil (L 3.000 mm kürzbar)**  
Cable feeder incl. canopy and steel cable (L 3.000 mm shortable)  
weiß / white

**136-804-100** 3-polig, 3-pole (3 x 0,75 mm<sup>2</sup>)

**136-807-100** 5-polig, 5-pole (5 x 0,75 mm<sup>2</sup>)

silbergrau / silver grey

**136-804-200** 3-polig, 3-pole (3 x 0,75 mm<sup>2</sup>)

**136-807-200** 5-polig, 5-pole (5 x 0,75 mm<sup>2</sup>)

**Blindabdeckung (L max. 3.000 mm)**  
Aluminium  
Blank element (L 3.000 mm)  
Aluminium  
weiß / white

**136-811-100-xxxx (mm)**

silbergrau / silver grey

**136-811-200-xxxx (mm)**

**Bitte Bestellhinweis auf Seite 183 beachten.**  
Please note ordering information on page 183.

### Zubehör für Einbauleuchte rahmenlos im Gipseinbaukanal Accessories for frameless recessed light in gypsum channel

**Demontagewerkzeug** für im Aluminiumprofil eingebaute Leuchteneinheiten  
Dismantling tool for lighting units installed in aluminium profiles  
**136-808-000**

**Einbaukanal aus Gips**  
Gypsum installation channel  
**136-011-000** L 2.000 mm 11,2 kg

**Einbaukanal aus Gips 90°**  
Gypsum installation channel 90°  
**136-013-000** L 1.000 x 1.000 mm 11,2 kg

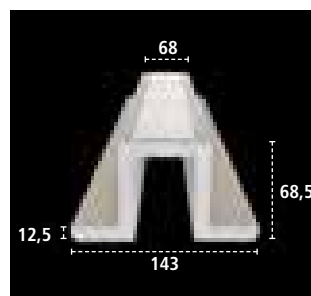

# SYSTEM 40

## Einbausystem mit Einbau- rahmen für den Einbau in Gipsdecken und -wände

- › Passgenaue LED-Leuchteinheiten inklusive der Abdeckungen PUBLIC, OFFICE oder WALLWASH separat bestellen (S.174/175)
- › System endlos verlängerbar

## Recessed light with installa- tion frame for plasterboard ceilings and walls

- › Please order matching LED lighting units separately, including PUBLIC, OFFICE or WALLWASH covers (p. 174/175)
- › Indefinitely extensible system



**Einbautiefe**  
depth of installation  
100 mm

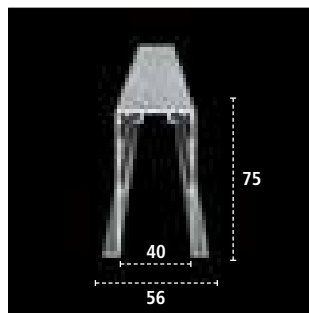

**Aluminiumprofil mit Einbau-  
rahmen**  
Aluminium profile with installation  
frame

(L max. 3.000 mm)

weiß / white

136-003-100-xxxx (mm)

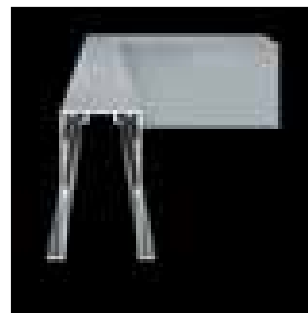

**Aluminiumprofil mit  
Einbau-rahmen 90°**

Aluminium profile with  
installation frame 90°

weiß / white

136-007-100 590 x 590 mm

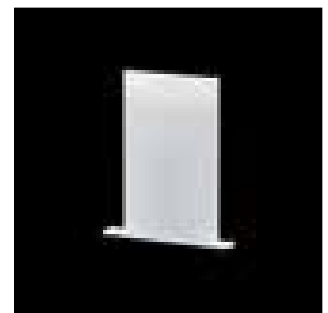

**2 Enddeckel mit Einbau-  
rahmen**

2 end caps with installation frame

weiß / white

136-805-100 75 x 40 x 2 mm (8 mm)

### Blindabdeckung (L max 3.000 mm)

Aluminium

Blank element Aluminium

weiß / white

136-810-100-xxxx (mm)

### Demontagewerkzeug für im Aluminium- profil eingebaute Leuchteinheiten

Dismantling tool for lighting units

installed in aluminium profiles

136-808-000

**Bitte Bestellhinweis auf Seite 183 beachten.**

Please note ordering information on page 183.

# SYSTEM 40 +

## Einbausystem mit Einbau- rahmen für den Einbau in Gipsdecken und -wände

- › Passgenaue LED-Leuchteinheiten inklusive der Abdeckung PUBLIC separat bestellen (S. 174/175)
- › System endlos verlängerbar

## Recessed light with installa- tion frame for plasterboard ceilings and walls

- › Please order matching LED lighting units separately, including PUBLIC cover (p. 174/175)
- › Indefinitely extensible system



**Einbautiefe**  
depth of installation  
80 mm

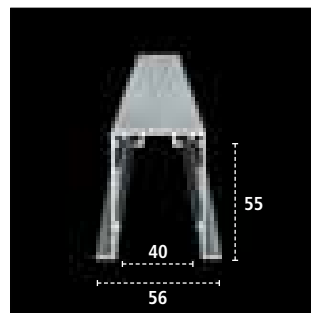

**Aluminiumprofil mit Einbauahmen**  
Aluminium profile with  
installation frame  
(L max. 3.000 mm)  
weiß / white  
136-004-100-xxxx (mm)



**Aluminiumprofil mit Einbauahmen 90°**  
Aluminium profile with installation  
frame 90°  
weiß / white  
136-008-100 590 x 590 mm



**2 Enddeckel mit Einbauahmen**  
2 end caps with installation frame  
weiß / white  
136-806-100 75 x 40 x 2 mm (8 mm)

**Blindabdeckung (L max 3.000 mm)**  
Aluminium  
Blank element (L max 3.000 mm)  
Aluminium  
weiß / white  
136-811-100-xxxx (mm)

**Demontagewerkzeug für im Aluminium-  
profil eingebaute Leuchteinheiten**  
Dismantling tool for lighting units  
installed in aluminium profiles  
136-808-000

## Bestellhinweis Aluminiumprofil / Ordering information for aluminium profiles

Bitte ergänzen Sie die Artikelnummer mit der gewünschten Profillänge: L = xxxx (mm)  
Die Profillänge errechnet sich durch die Addition der Länge der Leuchteinheiten ohne Enddeckel  
(Schnellrechentabelle Seite 176).  
Die erforderlichen Leuchteinheiten bitte separat bestellen.

Please complete the article number with the length of the profile: L = xxxx (mm)  
The profile length is calculated by adding the lengths of the lighting units without end caps  
(Easy planning guide page 176).  
Please order the required lighting units separately.

### Bestellbeispiel Order example

3 x 844 mm (136-021-003) = Addition der Länge der Leuchteinheiten  
Addition of the lengths of the lighting units

L = 2.532 mm

**L = 2.532 mm = 136-001-200-2532**

**Aluminiumprofil + 2 Enddeckel = Gesamtlänge des Systems**  
Aluminium profile + 2 end caps = total length of the system



Die Pendel- und Wandleuchten TENDO 1 lassen sich mit Eck- und T-Verbindern zum System erweitern. Damit werden die Leuchten aus eloxiertem Aluminium mit satinierter Acrylabdeckung zum idealen Begleiter für Flure oder zur geradlinigen Grundbeleuchtung in großen Räumen – beispielsweise in Büro- und Konferenzräumen.

The TENDO 1 pendant and wall lights can be extended to a system with corner and T connectors. This makes the anodised aluminium lights with a satinised acrylic cover ideal companions for corridors or linear basic illumination of large rooms, for example offices or conference rooms.



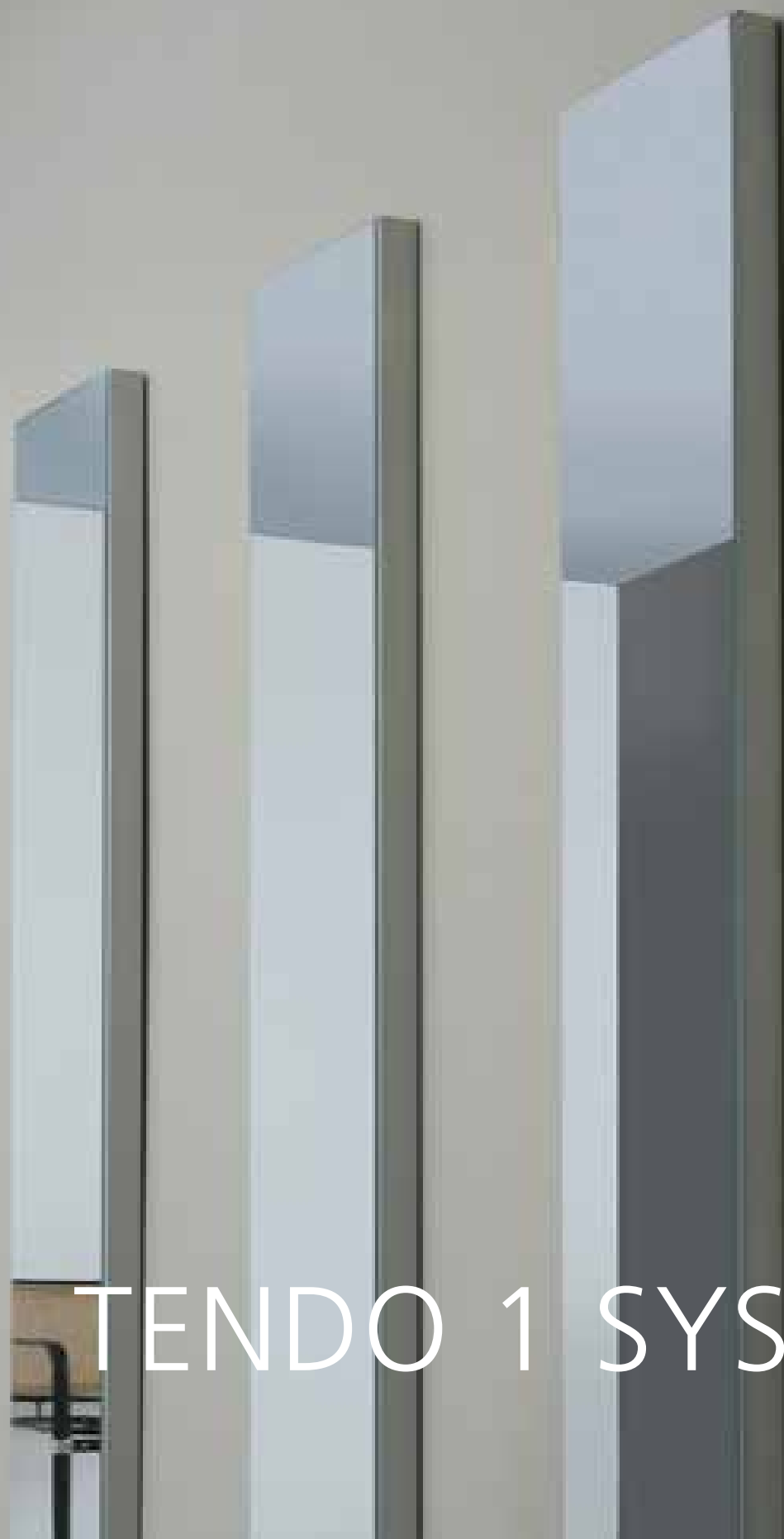

# TENDO 1 SYSTEM

# TENDO 1 SYSTEM

## System

- › System als Pendelleuchte oder Wandleuchte
- › Oberfläche Aluminium eloxiert
- › Fertig montierte T16-Leuchtenmodule in unterschiedlichen Längen
- › Abdeckung PUBLIC mit satinierter Optik
- › 90° und T-Verbinder erhältlich
- › Lichtverteilung direkt/indirekt



## System

- › System as pendant or wall light
- › Surface aluminium anodised
- › Fully assembled T16 lighting units in several different lengths
- › Cover PUBLIC with satinised optic
- › 90° and T-connector available
- › Direct/indirect light distribution

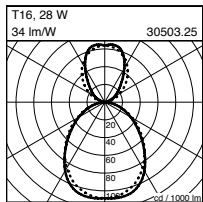

## Leuchtenmodul T16 mit Acrylabdeckung

Lighting module T16 with acrylic cover

L	T16	ON /OFF	DIM 1-10V	DIM DALI	kg
590 mm	1 x T16, 14/24 W, EVG	<b>30501.25</b>	<b>30501.251</b>	<b>30501.252</b>	2,0
890 mm	1 x T16, 21/39 W, EVG	<b>30502.25</b>	<b>30502.251</b>	<b>30502.252</b>	2,6
1.190 mm	1 x T16, 28/54 W, EVG	<b>30503.25</b>	<b>30503.251</b>	<b>30503.252</b>	3,4
1.490 mm	1 x T16, 35/49 W, EVG	<b>30504.25</b>	<b>30504.251</b>	<b>30504.252</b>	4,2
1.790 mm	2 x T16, 21/39 W, EVG	<b>30505.25</b>	<b>30505.251</b>	<b>30505.252</b>	5,0
2.390 mm	2 x T16, 28/54 W, EVG	<b>30506.25</b>	<b>30506.251</b>	<b>30506.252</b>	6,4
2.672 mm	3 x T16, 21/39 W, EVG	<b>30507.25</b>	<b>30507.251</b>	<b>30507.252</b>	7,0
2.990 mm	2 x T16, 35/49 W, EVG	<b>30508.25</b>	<b>30508.251</b>	<b>30508.252</b>	8,0
3.572 mm	3 x T16, 28/54 W, EVG	<b>30509.25</b>	<b>30509.251</b>	<b>30509.252</b>	10,0
4.472 mm	3 x T16, 35/49 W, EVG	<b>30510.25</b>	<b>30510.251</b>	<b>30510.252</b>	12,8

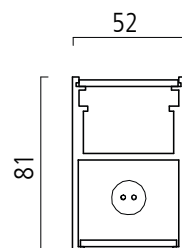

Zubehör bitte separat bestellen  
Please order accessories separately

Passende TENDO 1 Wand-, Decken- und Pendelleuchten auf S. 130  
Corresponding TENDO 1 wall-, ceiling- and pendant lights on page 130.

## Zubehör / Accessories



**1 Enddeckel**  
1 End cap  
**30129.25**



**Kabeleinspeisung**  
inkl. Baldachin und Stahlseil, kürzbar  
**Cable feeder**  
incl. canopy and steel cable, shortable  
L 3.000 mm  
**30300.25** 3-polig / 3-pole 3 x 0,75 mm<sup>2</sup>  
**30301.25** 5-polig / 5-pole 5 x 1,5 mm<sup>2</sup>



**Stahlseilaufhängung,**  
kürzbar L 3.000 mm (je 1,5 m)  
**Steel cable suspension,**  
shortable L 3.000 mm (per 1.5 m)  
**30105.25**



**Leerprofil,** inkl. Acrylabdeckung  
oben und unten satiniert  
**Blank profile,** incl. acrylic cover on top  
and bottom satinised  
L 500 mm 1,4 kg  
**30200.25**  
L 1.000 mm 2,8 kg  
**30201.25**  
L 2.000 mm 4,2 kg  
**30202.25**



**Eckverbinder 90°**  
inkl. Linienvorbinder  
**Angle connector 90°**  
incl. line connectors  
200 x 200 mm  
**30122.25**



**Wandbefestigung,** Gesamtausladung  
mit Profil 68 mm, B 50 mm (je 1,5 m)  
**Wall fastening,** with profile  
(depth) 68 x (width) 50 mm (per 1.5 m)  
**30135.25**

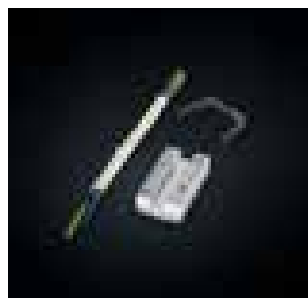

**Linienvorbinder**  
**Line connector**  
**30120.25**



**T-Verbinder,** inkl. Linienvorbinder  
**T-connector,** incl. line connectors  
348 x 200 mm  
**30132.25**

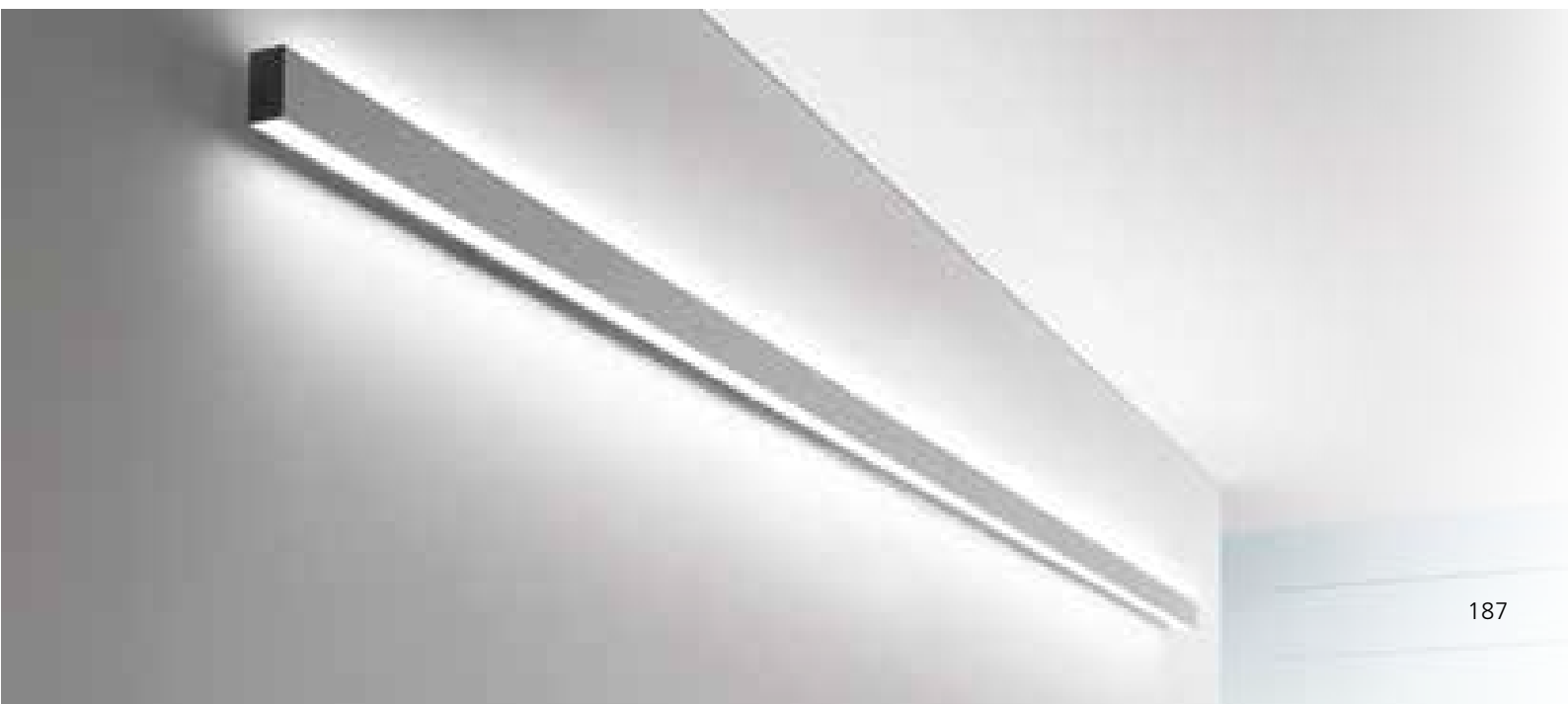



TENDO 2 sorgt mit direkt / indirekter Lichtverteilung als abgehängtes Lichtsystem oder als Wandsystem für die Beleuchtung moderner Architektur. Die geradlinigen Leuchten aus eloxiertem Aluminium lassen sich beliebig verlängern und rechtwinklig um die Ecke führen. Die Ausleuchtung ist nahezu schattenfrei und erfolgt über die gesamte Systemlänge. TENDO 2 kann wahlweise mit T16 Leuchtstofflampen oder LED bestückt werden. Darüber hinaus ist die untere Abdeckung wahlweise satiniert oder prismatisch und sorgt so für blendfreies Licht auch im Büro.

TENDO 2 provides illumination for modern architecture with direct/indirect light distribution in the form of suspended lighting systems or wall systems. The linear lights made of anodised aluminium can be extended as required and guided around corners at right angles. The illumination is virtually shadowless and extends over the entire length of the system. TENDO 2 can be equipped with either T16 fluorescent tubes or LEDs. Moreover, the lower cover can be delivered satinised or in prismatic design according to customer choice and thus ensures glare-free lighting, for example in offices.





# TENDO 2





# TENDO 2

# TENDO 2

## System

- › Direkter und indirekter Lichtanteil
- › System als Pendelleuchte oder Wandleuchte
- › Aluminiumprofil eloxiert
- › Passgenaue LED / T16 Leuchteneinheiten in unterschiedlichen Längen
- › Wahlweise satinierte Abdeckung PUBLIC oder blendfreie Optik OFFICE
- › Werkzeuglose Montage der Leuchteneinheiten im Aluminiumprofil



## System

- › Direct/indirect light distribution
- › System as pendant or wall light
- › Surface aluminium anodised
- › Matching LED / T16 lighting units in several different lengths
- › Choice between satinised cover PUBLIC and glare-free OFFICE optic
- › Tool-free assembly of lighting units in the aluminium profile

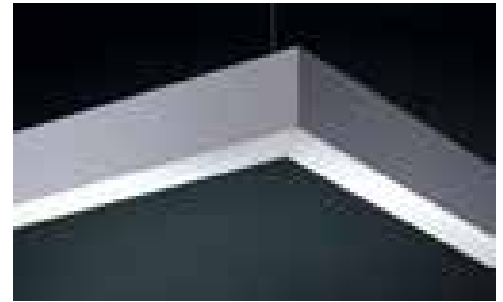
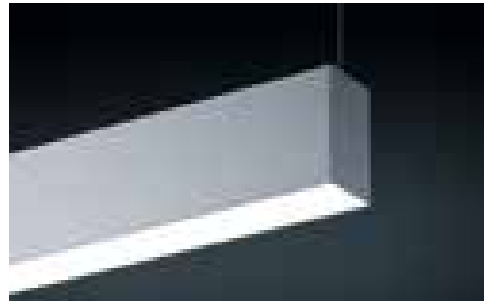

**Aluminiumprofil** inkl. oberer, satinierter Acrylabdeckung (L max. 3.000 mm)  
**Aluminium profile** incl. satinised acrylic cover on top (L max. 3.000 mm)  
**126-004-200-xxxx (mm)**

Bitte ergänzen Sie die Artikelnummer mit der gewünschten Profillänge: L = xxxx (mm).  
 Please complete the article number with the length of the profile: L = xxxx (mm).

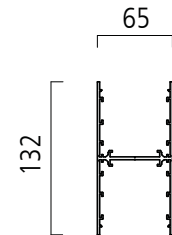

### Indirekt / indirect

T16 / 14 W, 21 W, 28 W, 35 W  
 LED / ca. 2.400 lm/m

### Direkt / direct

T16 / 14/24 W, 21/39 W, 28/54 W, 35/49 W  
 LED / ca. 2.400 lm/m (oder / or) ca. 4.300 lm/m

## Zubehör / Accessories

Bitte ergänzen Sie die Artikelnummer mit der gewünschten Acryllänge/Abdeckungslänge: L = xxxx (mm)  
 Please complete the article number with the length of acrylic/blank element: L = xxxx (mm)

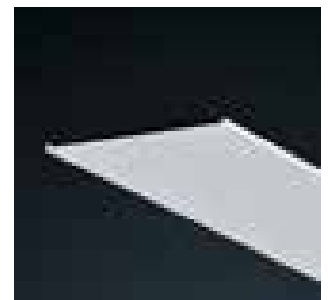

### Leuchteneinheiten, Bestellbeispiel und Schnellrechentabellen:

Lighting unit, order example and easy planning guide:

Seite / page 204 - 207

Aluminiumprofil, Zubehör + Leuchteneinheit bitte separat bestellen

Please order the aluminium profile, accessories + lighting units separately

### PUBLIC

#### Acrylabdeckung satiniert

Acrylic cover satinised

L max. 3.000 mm

**126-820-000-xxxx (mm) T16**

**126-850-000-xxxx (mm) LED**

### OFFICE

#### Prismatische Abdeckung

Prismatic diffuser

L max. 3.000 mm

**126-821-000-xxxx (mm) T16**

**126-851-000-xxxx (mm) LED**

### Blindabdeckung

Blank element

L max. 3.000 mm

Aluminium eloxiert / Aluminium anodised

**126-822-200-xxxx (mm)**

Acrylabdeckungen werden grundsätzlich abzüglich Ausdehnungsfaktor geliefert  
 Acrylic covers are generally supplied less expansion factor



**2 Enddeckel**  
2 End caps  
Tiefe / depth 2 mm  
**126-812-200**

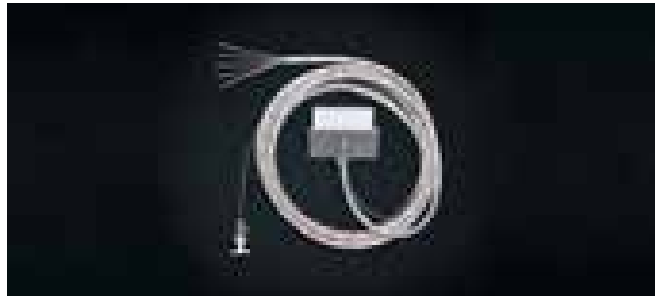

**Kabeleinspeisung**  
inkl. Baldachin und Stahlseil, kürzbar  
Cable feeder  
incl. canopy and steel cable, shortable  
Aluminium eloxiert / Aluminium anodised  
L 3.000 mm

**126-840-200** 3-polig / 3-pole 3 x 0,75 mm<sup>2</sup>  
**126-815-200** 5-polig / 5-pole 5 x 1,5 mm<sup>2</sup>  
**126-827-200** 7-polig / 7-pole 7 x 1,5 mm<sup>2</sup>



**Stahlseilaufhängung,**  
kürzbar L 3.000 mm (je 1,5 m)  
Steel cable suspension,  
shortable L 3.000 mm (per 1.5 m)  
**126-817-200**



**Eckverbinder 90°**  
Angle connector 90°  
200 x 200 mm  
PUBLIC  
inkl. Acrylabdeckung satiniert  
incl. acrylic cover satinised  
**126-804-200**  
OFFICE  
inkl. prismatischer Abdeckung  
incl. prismatic diffuser  
**126-835-200**



**Linienverbinder**  
Line connector  
**126-808-000**



**Wandbefestigung,**  
Gesamtausladung mit Profil 80 mm  
(je 1,5 m)  
Wall fastening  
depth (incl. profile) 80 mm (per 1.5 m)  
**126-819-200**



STRONG ist das ideale Leuchtensystem, wenn eine homogene Ausleuchtung mit hohem Wirkungsgrad gefordert ist. Das lineare Beleuchtungssystem mit direkter Lichtverteilung – wahlweise mit T16 Leuchtstofflampen oder LED bestückt – ermöglicht eine ebenso strukturierte wie strukturierende Beleuchtung. Dabei besteht die Möglichkeit, die Beleuchtung mit STRONG 1 flächenbündig in die Gipskartonkonstruktionen von Decke und Wand zu integrieren sowie als Deckenanbau- oder abgehängtes System STRONG 2/3 in den Höhen von 72 mm und 100 mm zu realisieren. Alle Varianten können durch die Kombination von Leuchtenmodulen variabel verlängert werden. STRONG Systeme können mit Eckverbindungen auch rechtwinklig geführt werden. Als Alternative zur satinierten Acrylabdeckung steht eine prismatische Abdeckung zur Verfügung, beispielsweise für Büroräume.

STRONG is the ideal lighting system wherever homogeneous illumination with a high degree of efficiency is required. The linear lighting system with direct light distribution – equipped either with T16 fluorescent tubes or LEDs according to choice – provides an illumination which is both structured and structuring. There are also the options of integrating the light fittings recessed into the plasterboard structures of ceilings and walls with STRONG 1, or to have them installed as a STRONG 2/3 surface-mounted or pendant system at heights of 72 or 100 mm. All variants can be flexibly extended by combining several lighting modules with each other. STRONG 2 and 3 can also be guided around corners at right angles with the help of corner joints. For use in offices, a prismatic cover is available as an alternative to the satinised acrylic cover.

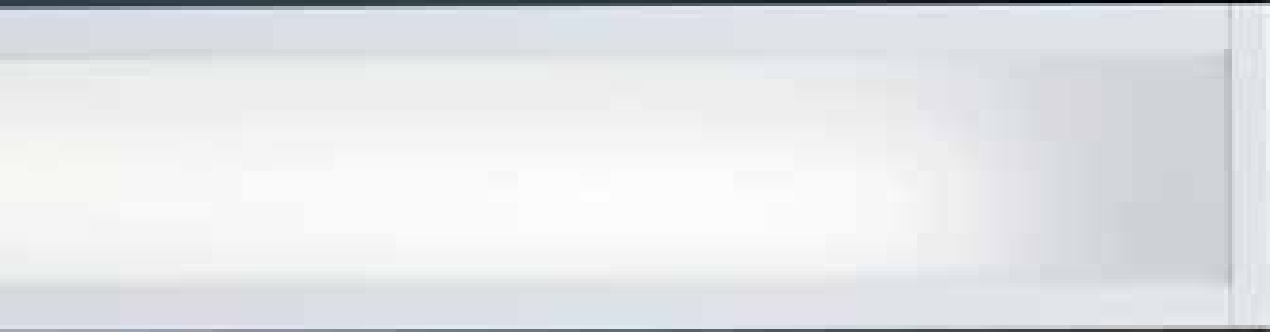

STRONG 1 | 2 | 3







# STRONG 1 | 2 | 3

# STRONG 1

## System

- › Einbausystem für Hohldecken
- › Aluminiumprofil weiß
- › Passgenaue LED / T16 Leuchteneinheiten in unterschiedlichen Längen
- › Wahlweise satinierte Abdeckung PUBLIC oder blendfreie Optik OFFICE
- › Werkzeuglose Montage der Leuchteneinheiten im Aluminiumprofil
- › Lichtverteilung direkt
- › Einbautiefe 110 mm



## System

- › Recessed system for hollow ceilings
- › Aluminium profile white
- › Matching LED / T16 lighting units in several different lengths
- › Choice between satinised cover PUBLIC and glare-free OFFICE optic
- › Tool-free assembly of the lighting units in the aluminium profile
- › Direct light distribution
- › Depth of installation 110 mm

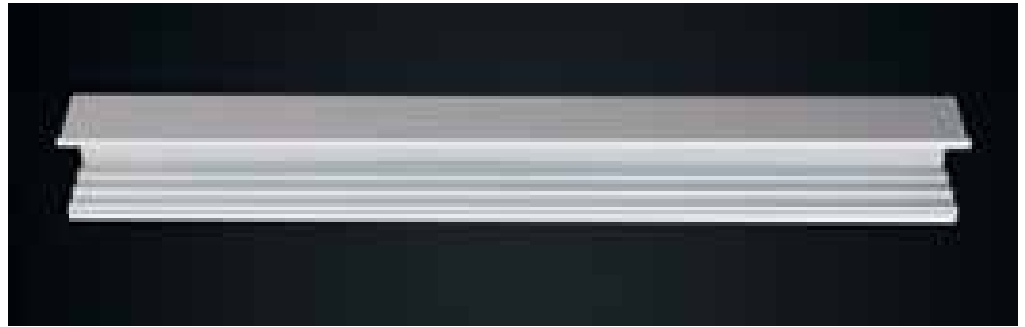

**Aluminiumprofil** (L max. 3.000 mm)  
**Aluminium profile** (L max. 3.000 mm)  
 weiß / white  
**126-001-100-xxxx (mm)**

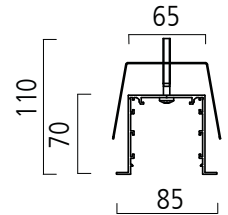
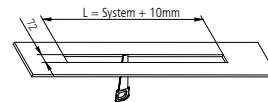

Bitte ergänzen Sie die Artikelnummer mit der gewünschten Profillänge: L = xxxx (mm).  
 Please complete the article number with the length of the profile: L = xxxx (mm).

## Zubehör / Accessories



**2 Enddeckel**  
 2 End caps  
 Tiefe / depth 2 mm  
 weiß / white  
**126-809-100**



**Eckverbinder 90° / Angle connector 90°**  
 200 x 200 mm  
 PUBLIC  
 inkl. Acrylabdeckung satiniert  
 incl. acrylic cover satinised  
**126-801-100**  
 OFFICE  
 inkl. prismatischer Abdeckung  
 incl. prismatic diffuser  
**126-832-100**



**Linienverbinder**  
 Line connector  
**126-806-000**

Bitte ergänzen Sie die Artikelnummer mit der gewünschten Acryllänge/Abdeckungsgröße: L = xxxx (mm)  
 Please complete the article number with the length of acrylic/blank element: L = xxxx (mm)

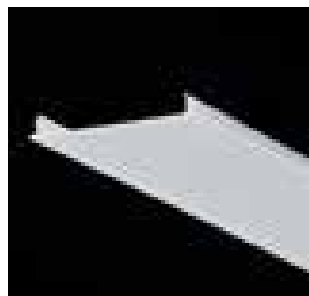

**PUBLIC**  
**Acrylabdeckung satiniert**  
 Acrylic cover satinised  
 L max. 3.000 mm  
**126-820-000-xxxx (mm) T16**  
**126-850-000-xxxx (mm) LED**

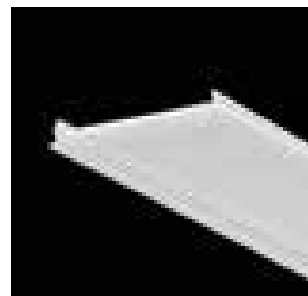

**OFFICE**  
**Prismatische Abdeckung**  
 Prismatic diffuser  
 L max. 3.000 mm  
**126-821-000-xxxx (mm) T16**  
**126-851-000-xxxx (mm) LED**



**Blindabdeckung**  
 Blank element  
 L max. 3.000 mm  
 weiß / white  
**126-822-100-xxxx (mm)**

### Leuchteneinheiten, Bestellbeispiel und Schnellrechenabellen:

Lighting units, order example and easy planning guide:

Seite / page 204 - 207

Aluminiumprofil, Zubehör + Leuchteneinheit bitte separat bestellen

Please order the aluminium profile, accessories + lighting units separately

Acrylabdeckungen werden grundsätzlich abzüglich Ausdehnungsfaktor geliefert  
 Acrylic covers are generally supplied less expansion factor



# STRONG 2

## System

- › System als Aufbau-, Pendel- oder Wandleuchte
- › Aluminiumprofil eloxiert oder weiß
- › Passgenaue LED / T16 Leuchteneinheiten in unterschiedlichen Längen
- › Wahlweise satinierte Abdeckung PUBLIC oder blendfreie Optik OFFICE
- › Werkzeuglose Montage der Leuchteneinheiten im Aluminiumprofil
- › Lichtverteilung direkt

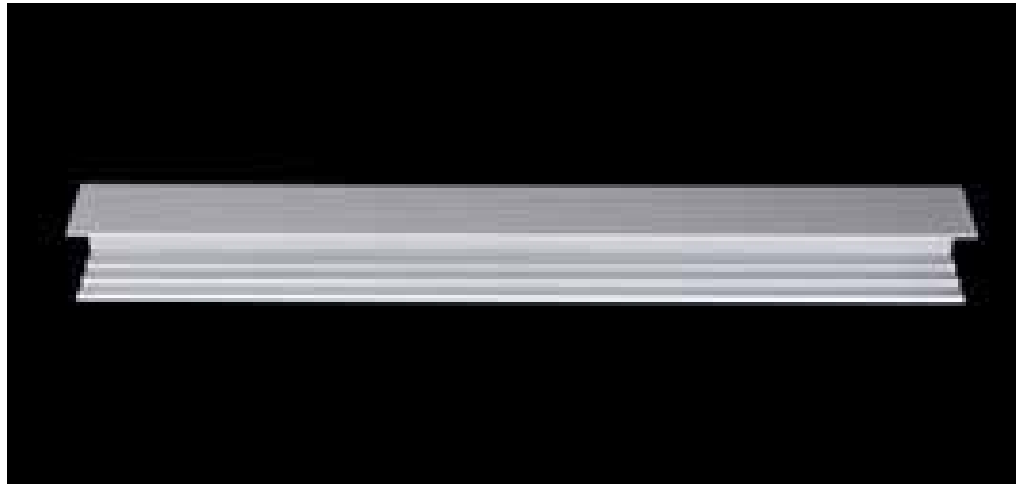

## System

- › System for surface, pendant or wall installation
- › Aluminium profile anodised or white
- › Matching LED / T16 lighting units in several different lengths
- › Choice between satinised cover PUBLIC and glare-free OFFICE optic
- › Tool-free assembly of the lighting units in the aluminium profile
- › Direct light distribution

**Aluminiumprofil** (L max. 3.000 mm)  
**Aluminium profile** (L max. 3.000 mm)  
 weiß / white  
**126-002-100-xxxx (mm)**  
 Aluminium eloxiert / Aluminium anodised  
**126-002-200-xxxx (mm)**

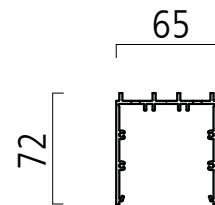

Bitte ergänzen Sie die Artikelnummer mit der gewünschten Profillänge: L = xxxx (mm)  
 Please complete the article number with the length of the profile: L = xxxx (mm)

## Zubehör / Accessories

Bitte ergänzen Sie die Artikelnummer mit der gewünschten Acryllänge/Abdeckungsgröße: L = xxxx (mm)  
 Please complete the article number with the length of acrylic/blank element: L = xxxx (mm)

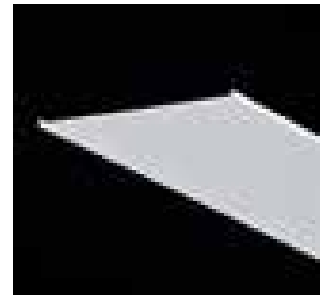
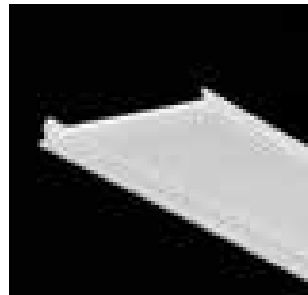

### Leuchteneinheiten, Bestellbeispiel und Schnellrechenabellen:

Lighting units, order example and easy planning guide:

Seite / page 204 - 207

Aluminiumprofil, Zubehör + Leuchteneinheit bitte separat bestellen

Please order the aluminium profile, accessories + lighting units separately

**PUBLIC**  
**Acrylabdeckung satiniert**  
 Acrylic cover satinised  
 L max. 3.000 mm  
**126-820-000-xxxx (mm) T16**  
**126-850-000-xxxx (mm) LED**

**OFFICE**  
**Prismatische Abdeckung**  
 Prismatic diffuser  
 L max. 3.000 mm  
**126-821-000-xxxx (mm) T16**  
**126-851-000-xxxx (mm) LED**

**Blindabdeckung**  
 Blank element  
 L max. 3.000 mm  
 weiß / white  
**126-822-100-xxxx (mm)**  
 Aluminium eloxiert  
 Aluminium anodised  
**126-822-200-xxxx (mm)**

Acrylabdeckungen werden grundsätzlich abzüglich Ausdehnungsfaktor geliefert  
 Acrylic covers are generally supplied less expansion factor

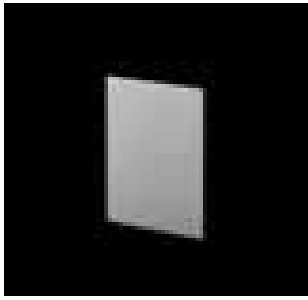

**2 Enddeckel**

2 End caps

Tiefe / depth 2 mm

weiß / white

**126-810-100**

Aluminium eloxiert / Aluminium anodised

**126-810-200**



**Kabeleinspeisung**

inkl. Baldachin und Stahlseil, kürzbar

Cable feeder

incl. canopy and steel cable, shortable

weiß / white L 3.000 mm

**126-839-100** 3-polig / 3-pole 3 x 0,75 mm<sup>2</sup>

**126-813-100** 5-polig / 5-pole 5 x 1,5 mm<sup>2</sup>

**126-814-100** 7-polig / 7-pole 7 x 1,5mm<sup>2</sup>

Aluminium eloxiert / Aluminium anodised

L 3.000 mm

**126-839-200** 3-polig / 3-pole 3 x 0,75 mm<sup>2</sup>

**126-813-200** 5-polig / 5-pole 5 x 1,5 mm<sup>2</sup>

**126-814-200** 7-polig / 7-pole 7 x 1,5mm<sup>2</sup>



**Stahlseilaufhängung,**

kürzbar L 3.000 mm (je 1,5 m)

Steel cable suspension,

shortable L 3.000 mm (per 1.5 m)

weiß / white

**126-816-100**

Aluminium eloxiert

Aluminium anodised

**126-816-200**



**Eckverbinder 90°**

Angle connector 90°

200 x 200 mm

PUBLIC

inkl. Acrylabdeckung satiniert

incl. acrylic cover satinised

weiß / white

**126-802-100**

Aluminium eloxiert

Aluminium anodised

**126-802-200**

OFFICE

inkl. prismatischer Abdeckung

incl. prismatic diffuser

weiß / white

**126-833-100**

Aluminium eloxiert

Aluminium anodised

**126-833-200**



**Linienverbinder**

Line connector

**126-806-000**



**Wandbefestigung,**

Gesamtausladung mit Profil 80 mm

(je 1,5 m)

Wall fastening

depth (incl. profile) 80 mm (per 1.5 m)

weiß / white

**126-818-100**

Aluminium eloxiert

Aluminium anodised

**126-818-200**



# STRONG 3

## System

- › System als Aufbau-, Pendel- oder Wandleuchte
- › Aluminiumprofil eloxiert oder weiß
- › Passgenaue LED / T16 Leuchteneinheiten in unterschiedlichen Längen
- › Wahlweise satinierte Abdeckung PUBLIC oder blendfreie Optik OFFICE
- › Werkzeuglose Montage der Leuchteneinheiten im Aluminiumprofil
- › Lichtverteilung direkt



## System

- › System for surface, pendant or wall installation
- › Aluminium profile anodised or white
- › Matching LED / T16 lighting units in several different lengths
- › Choice between satinised cover PUBLIC and glare-free OFFICE optic
- › Tool-free assembly of the lighting units in the aluminium profile
- › Direct light distribution

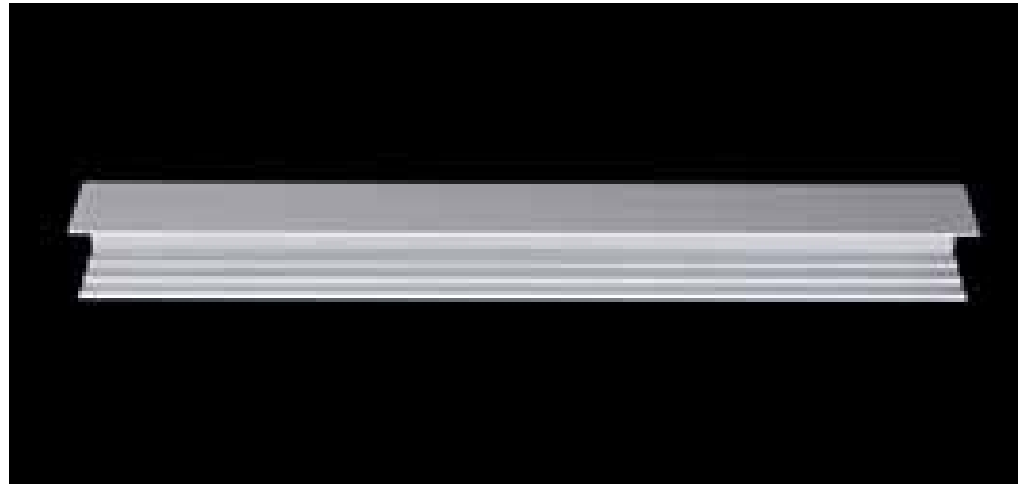

**Aluminiumprofil** (L max. 3.000 mm)  
**Aluminium profile** (L max. 3.000 mm)  
 weiß / white  
**126-003-100-xxxx (mm)**  
 Aluminium eloxiert / Aluminium anodised  
**126-003-200-xxxx (mm)**

Bitte ergänzen Sie die Artikelnummer mit der gewünschten Profillänge: L = xxxx (mm)  
 Please complete the article number with the length of the profile: L = xxxx (mm)

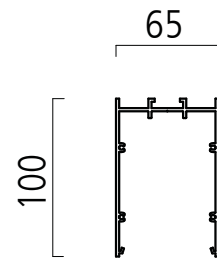

## Zubehör / Accessories

Bitte ergänzen Sie die Artikelnummer mit der gewünschten Acryllänge/Abdeckungsgröße: L = xxxx (mm)  
 Please complete the article number with the length of acrylic/blank element: L = xxxx (mm)

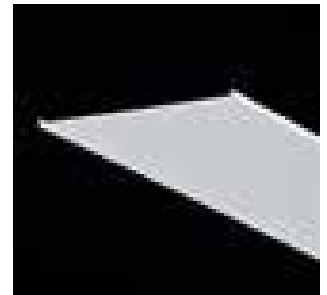
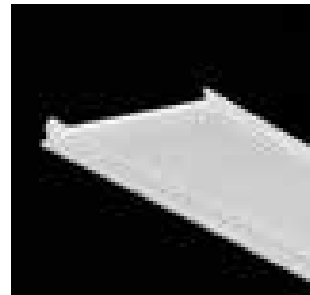

### Leuchteneinheiten, Bestellbeispiel und Schnellrechenstabellen:

Lighting units, order example and easy planning guide:

Seite / page 204 - 207

Aluminiumprofil, Zubehör + Leuchteneinheit bitte separat bestellen

Please order the aluminium profile, accessories + lighting units separately

**PUBLIC**  
**Acrylabdeckung satiniert**  
 Acrylic cover satinised  
 L max. 3.000 mm  
**126-820-000-xxxx (mm) T16**  
**126-850-000-xxxx (mm) LED**

**OFFICE**  
**Prismatische Abdeckung**  
 Prismatic diffuser  
 L max. 3.000 mm  
**126-821-000-xxxx (mm) T16**  
**126-851-000-xxxx (mm) LED**

**Blindabdeckung**  
 Blank element  
 L max. 3.000 mm  
 weiß / white  
**126-822-100-xxxx (mm)**  
 Aluminium eloxiert  
 Aluminium anodised  
**126-822-200-xxxx (mm)**

Acrylabdeckungen werden grundsätzlich abzüglich Ausdehnungsfaktor geliefert  
 Acrylic covers are generally supplied less expansion factor

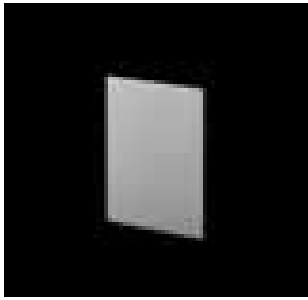

**2 Enddeckel**

2 End caps

Tiefe / depth 2 mm

weiß / white

**126-811-100**

Aluminium eloxiert / Aluminium anodised

**126-811-200**

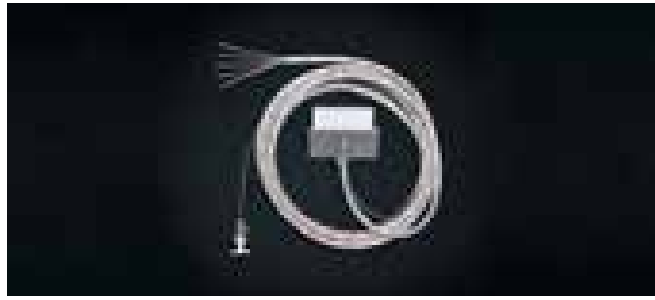

**Kabeleinspeisung**

inkl. Baldachin und Stahlseil, kürzbar

Cable feeder

incl. canopy and steel cable, shortable

weiß / white L 3.000 mm

**126-839-100** 3-polig / 3-pole 3 x 0,75 mm<sup>2</sup>

**126-813-100** 5-polig / 5-pole 5 x 1,5 mm<sup>2</sup>

**126-814-100** 7-polig / 7-pole 7 x 1,5 mm<sup>2</sup>

Aluminium eloxiert / Aluminium anodised

L 3.000 mm

**126-839-200** 3-polig / 3-pole 3 x 0,75 mm<sup>2</sup>

**126-813-200** 5-polig / 5-pole 5 x 1,5 mm<sup>2</sup>

**126-814-200** 7-polig / 7-pole 7 x 1,5 mm<sup>2</sup>



**Stahlseilaufhängung,**

kürzbar L 3.000 mm (je 1,5 m)

Steel cable suspension,

shortable L 3.000 mm (per 1.5 m)

weiß / white

**126-816-100**

Aluminium eloxiert

Aluminium anodised

**126-816-200**



**Eckverbinder 90°**

Angle connector 90°

200 x 200 mm

PUBLIC

inkl. Acrylabdeckung satiniert

incl. acrylic cover satinised

weiß / white

**126-803-100**

Aluminium eloxiert

Aluminium anodised

**126-803-200**

OFFICE

inkl. prismatischer Abdeckung

incl. prismatic diffuser

weiß / white

**126-834-100**

Aluminium eloxiert

Aluminium anodised

**126-834-200**

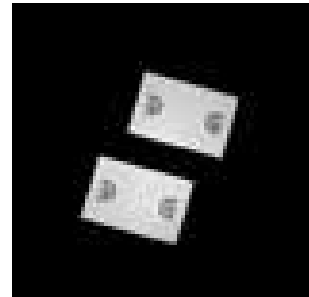

**Linienverbinder**

Line connector

**126-807-000**



**Wandbefestigung,**

Gesamtausladung mit Profil 80 mm

(je 1,5 m)

Wall fastening

depth (incl. profile) 80 mm (per 1.5 m)

weiß / white

**126-818-100**

Aluminium eloxiert

Aluminium anodised

**126-818-200**



# STRONG 1,2,3 / TENDO 2

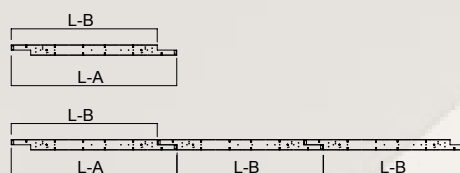
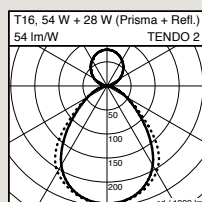
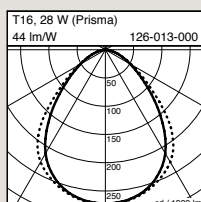
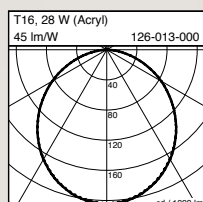
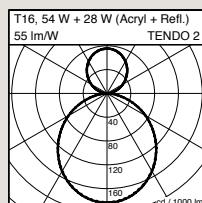
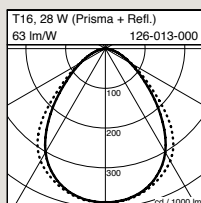
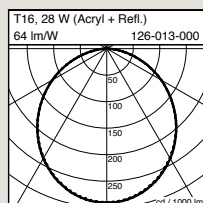

## Leuchteneinheit T16 mit 5 poliger Durchgangsverdrahtung, diagonal überlappend

Lighting unit T16 with 5 pole electrical connection, diagonally overlapping

L-A	L-B	T16	ON/OFF	DIM 1-10V	DIM DALI	kg	Reflektor
580 mm	495 mm	1 x T16, 14/24 W, EVG	<b>126-011-000</b>	<b>126-011-010</b>	<b>126-011-020</b>	0,8	<b>126-823-000</b>
880 mm	770 mm	1 x T16, 21/39 W, EVG	<b>126-012-000</b>	<b>126-012-010</b>	<b>126-012-020</b>	1,0	<b>126-824-000</b>
1.180 mm	1.070 mm	1 x T16, 28/54 W, EVG	<b>126-013-000</b>	<b>126-013-010</b>	<b>126-013-020</b>	1,3	<b>126-825-000</b>
1.480 mm	1.370 mm	1 x T16, 35/49 W, EVG	<b>126-014-000</b>	<b>126-014-010</b>	<b>126-014-020</b>	1,5	<b>126-826-000</b>

## Leuchteneinheit T16 für Einzelleuchten, gerade

Lighting unit T16 for single luminaires, straight

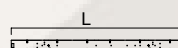

L	T16	ON/OFF	DIM 1-10V	DIM DALI	KG	Reflektor
880 mm	1 x T16, 21/39 W, EVG	<b>126-040-000</b>	<b>126-040-010</b>	<b>126-040-020</b>	1,0	<b>126-829-000</b>
1.180 mm	1 x T16, 28/54 W, EVG	<b>126-041-000</b>	<b>126-041-010</b>	<b>126-041-020</b>	1,3	<b>126-830-000</b>
1.480 mm	1 x T16, 35/49 W, EVG	<b>126-042-000</b>	<b>126-042-010</b>	<b>126-042-020</b>	1,5	<b>126-831-000</b>



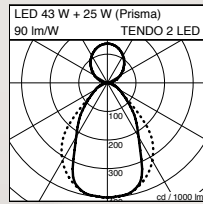
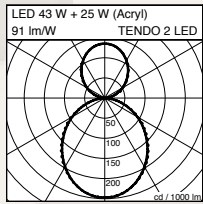
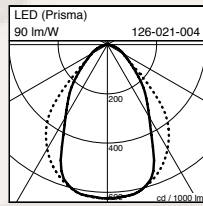
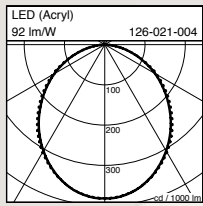

L-A

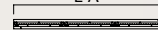

**Leuchteinheit LED mit 5 poliger Durchgangsverdrahtung (LED Leistung ca. 2400 lm/m) Ra > 80**

Lighting unit LED with 5 pole electrical connection (LED power appr. 2400 lm/m) Ra > 80



		3000K					4000K				
L-A	L-B	W	PUBLIC	OFFICE	ON /OFF	DIM DALI	PUBLIC	OFFICE	ON /OFF	DIM DALI	kg
850 mm	841 mm	16 W	80 lm/W	78 lm/W	<b>126-031-003</b>	<b>126-031-023</b>	82 lm/W	80 lm/W	<b>126-031-004</b>	<b>126-031-024</b>	0,6
990 mm	981 mm	18 W	83 lm/W	81 lm/W	<b>126-035-003</b>	<b>126-035-023</b>	85 lm/W	83 lm/W	<b>126-035-004</b>	<b>126-035-024</b>	0,7
1.130 mm	1.121 mm	20 W	85 lm/W	83 lm/W	<b>126-032-003</b>	<b>126-032-023</b>	88 lm/W	86 lm/W	<b>126-032-004</b>	<b>126-032-024</b>	0,8
1.410 mm	1.401 mm	25 W	85 lm/W	83 lm/W	<b>126-033-003</b>	<b>126-033-023</b>	88 lm/W	86 lm/W	<b>126-033-004</b>	<b>126-033-024</b>	1,0
1.690 mm	1.681 mm	29 W	88 lm/W	86 lm/W	<b>126-034-003</b>	<b>126-034-023</b>	91 lm/W	89 lm/W	<b>126-034-004</b>	<b>126-034-024</b>	1,2

L-A

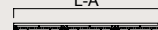

**Leuchteinheit LED mit 5 poliger Durchgangsverdrahtung (LED Leistung ca. 4300 lm/m) Ra > 80**

Lighting unit LED with 5 pole electrical connection (LED power appr. 4300 lm/m) Ra > 80

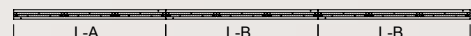

		3000K					4000K				Tunable white 3000-6000K	
L-A	L-B	W	PUBLIC	OFFICE	ON /OFF	DIM DALI	PUBLIC	OFFICE	ON /OFF	DIM DALI	DIM DALI	kg
850 mm	841 mm	27 W	87 lm/W	85 lm/W	<b>126-020-003</b>	<b>126-020-023</b>	89 lm/W	88 lm/W	<b>126-020-004</b>	<b>126-020-024</b>	<b>126-020-029*</b>	0,6
990 mm	981 mm	31 W	88 lm/W	86 lm/W	<b>126-024-003</b>	<b>126-024-023</b>	91 lm/W	89 lm/W	<b>126-024-004</b>	<b>126-024-024</b>		0,7
1.130 mm	1.121 mm	35 W	89 lm/W	87 lm/W	<b>126-021-003</b>	<b>126-021-023</b>	92 lm/W	90 lm/W	<b>126-021-004</b>	<b>126-021-024</b>	<b>126-021-029*</b>	0,8
1.410 mm	1.401 mm	43 W	91 lm/W	89 lm/W	<b>126-022-003</b>	<b>126-022-023</b>	94 lm/W	92 lm/W	<b>126-022-004</b>	<b>126-022-024</b>	<b>126-022-029*</b>	1,0
1.690 mm	1.681 mm	51 W	92 lm/W	90 lm/W	<b>126-023-003</b>	<b>126-023-023</b>	95 lm/W	93 lm/W	<b>126-023-004</b>	<b>126-023-024</b>		1,2

**PUBLIC** Acrylabdeckung satiniert / Acrylic cover satinised

**OFFICE** Prismatische Abdeckung / Prismatic diffuser

\* DALI DT8 (Device Type B) erforderlich / required

# SIZE / STRONG 1,2,3 / TENDO 2

## Schnellrechentabelle Easy planning guide

### Leuchteneinheiten T16 diagonal überlappend

Lighting units T16 diagonally overlapping

Systemlänge* System length*	Leuchteneinheit Lighting units							
	14/24 W		21/39 W		28/54 W		35/49 W	
	Anzahl Quantity	Länge Length	Anzahl Quantity	Länge Length	Anzahl Quantity	Länge Length	Anzahl Quantity	Länge Length
1.000 mm	1	580 mm	1	880 mm				
1.500 mm	2	1.075 mm			1	1.180 mm	1	1.480 mm
2.000 mm	3	1.570 mm	2	1.650 mm				
2.500 mm	4	2.065 mm	3	2.420 mm	2	2.250 mm		
3.000 mm	5	2.560 mm					2	2.850 mm
3.500 mm	6	3.055 mm	4	3.190 mm	3	3.320 mm		
4.000 mm	7	3.550 mm	5	3.960 mm				
4.500 mm	8	4.045 mm			4	4.390 mm	3	4.220 mm
5.000 mm	9	4.540 mm	6	4.730 mm				
5.500 mm	10	5.035 mm	7	5.500 mm	5	5.460 mm		
6.000 mm	11	5.530 mm	7	5.500 mm			4	5.590 mm
6.500 mm	12	6.025 mm	8	6.270 mm	6	6.530 mm		
7.000 mm	13	6.520 mm					5	6.960 mm
7.500 mm	14	7.015 mm	9	7.040 mm				
8.000 mm	15	7.510 mm	10	7.810 mm	7	7.600 mm		
8.500 mm	17	8.500 mm					6	8.330 mm
9.000 mm	18	8.995 mm	11	8.580 mm	8	8.670 mm		
9.500 mm	19	9.490 mm	12	9.350 mm				
10.000 mm	20	9.985 mm			9	9.740 mm	7	9.700 mm
10.500 mm	21	10.480 mm	13	10.120 mm				
11.000 mm	22	10.975 mm	14	10.890 mm	10	10.810 mm		
11.500 mm	23	11.470 mm	15	11.660 mm			8	11.070 mm
12.000 mm	24	11.965 mm			11	11.880 mm		
12.500 mm	25	12.460 mm	16	12.430 mm			9	12.440 mm
13.000 mm	26	12.955 mm			12	12.950 mm		
13.500 mm	27	13.450 mm	17	13.200 mm				
14.000 mm	28	13.945 mm	18	13.970 mm			10	13.810 mm
14.500 mm	29	14.440 mm			13	14.020 mm		
15.000 mm	30	14.935 mm	19	14.740 mm				
15.500 mm	31	15.430 mm			14	15.090 mm	11	15.180 mm
16.000 mm	32	15.925 mm	20	15.510 mm				
16.500 mm	33	16.420 mm	21	16.280 mm	15	16.160 mm		
17.000 mm	34	16.915 mm					12	16.550 mm
17.500 mm	35	17.410 mm	22	17.050 mm	16	17.230 mm		
18.000 mm	36	17.905 mm	23	17.820 mm			13	17.920 mm
18.500 mm	37	18.400 mm			17	18.300 mm		
19.000 mm	38	18.895 mm	24	18.590 mm				
19.500 mm	39	19.390 mm	25	19.360 mm	18	19.370 mm	14	19.290 mm
20.000 mm	40	19.885 mm						

## Leuchteneinheiten LED

Lighting units LED

### 3.000 K / 4.000 K

Systemlänge* System length*	Anzahl der LED-Leuchteneinheiten Number of LED lighting units				
	841 mm	981 mm	1.121 mm	1.401 mm	1.681 mm
850 mm	1				
990 mm		1			
1.130 mm			1		
1.410 mm				1	
1.690 mm					1
1.831 mm	1	1			
1.971 mm	1		1		
2.111 mm		1	1		
2.251 mm			2		
2.391 mm		1		1	
2.531 mm			1	1	
2.671 mm		1			1
2.811 mm			1		1
2.952 mm	1	1	1		
3.091 mm				1	1
3.232 mm		1	2		
3.371 mm					2
3.512 mm		1	1	1	
3.652 mm			2	1	
3.792 mm		1		2	
3.932 mm			2		1
4.072 mm		1		1	1
4.212 mm				3	
4.352 mm		1			2
4.492 mm				2	1
4.633 mm	1	1	1		1
4.772 mm				1	2
4.913 mm		1	2		1
5.052 mm					3
5.473 mm		1		2	1
5.333 mm			1	3	
5.613 mm			2		2

Systemlänge* System length*	Anzahl der LED-Leuchteneinheiten Number of LED lighting units				
	841 mm	981 mm	1.121 mm	1.401 mm	1.681 mm
5.753 mm		1		1	2
5.893 mm				3	1
6.033 mm		1			3
6.173 mm				2	2
6.314 mm		1	2	1	1
6.453 mm				1	3
6.594 mm	1	1		1	2
6.733 mm					4
6.874 mm	1	1			3
7.014 mm				5	
7.154 mm		1	1		3
7.294 mm				4	1
7.434 mm		1		1	3
7.574 mm				3	2
7.714 mm		1			4
7.854 mm				2	3
7.995 mm	1	1	1		3
8.134 mm				1	4
8.275 mm		1	2		3
8.414 mm					5
8.555 mm		1	1	1	3
8.695 mm				5	1
8.835 mm		1	1		4
8.975 mm				4	2
9.115 mm		1		1	4
9.255 mm				3	3
9.395 mm		1			5
9.535 mm				2	4
9.676 mm	1	1	1		4
9.815 mm				1	5
9.956 mm		1	2		4
10.095 mm					6

### Tunable White

Systemlänge* System length*	Anzahl der LED-Leuchteneinheiten Number of LED lighting units		
	844 mm	1.121 mm	1.401 mm
850 mm	1		
1.130 mm		1	
1.410 mm			1
1.691 mm	2		
1.971 mm	1	1	
2.251 mm	1		1
2.531 mm		1	1
2.811 mm			2
3.092 mm	1	2	
3.372 mm		3	
3.652 mm		2	1
3.932 mm		1	2
4.212 mm			3
4.493 mm	1	2	1
4.773 mm		3	1
5.053 mm		2	2
5.333 mm		1	3
5.613 mm			4
5.894 mm	1	2	2
6.174 mm		3	2
6.454 mm		2	3
6.734 mm		1	4
7.014 mm			5
7.295 mm	1	2	3
7.575 mm		3	3
7.855 mm		2	4
8.135 mm		1	5
8.415 mm			6
8.696 mm		4	3
8.976 mm		3	4
9.256 mm		2	5
9.536 mm		1	6
9.816 mm			7

\* Alle Systemlängen ohne Enddeckel. / All system lengths excluding end caps.



Das Lichtsystem SIZE begleitet als Wandleuchte Verkehrswege oder setzt einzelne Flächen ins rechte Licht. Das Design ist dabei betont minimalistisch: Hinter einer Blende aus eloxiertem Aluminium scheint beidseitig Licht hervor. Erzeugt wird dieser Effekt durch ein Acryl-Profil als Leuchtenkörper, auf dem die Blende scheinbar vor der Wand schwebt. Die Leuchte lässt sich durch unterschiedlich lange LED- und T16-Leuchtenmodule und Linienverbinder variabel verlängern. Bei der Bestückung mit T16 Leuchtstofflampen ermöglichen versetzte Leuchtmittel über die gesamte Systemlänge eine nahezu schattenfreie Ausleuchtung.

The SIZE range is a wall lighting system to accompany traffic routes or present selected areas in their best light. The design is deliberately minimalist: Light emanates from opposite sides of an anodised aluminium panel. This effect is created by an acrylic housing on which the panel seemingly floats in front of the wall. The lighting system can be extended as desired with LED and T16 lighting modules of different lengths using line connectors. When equipped with fluorescent T16 tubes, virtually shadow-free illumination can be achieved by staggering the illuminants across the entire length of the system.

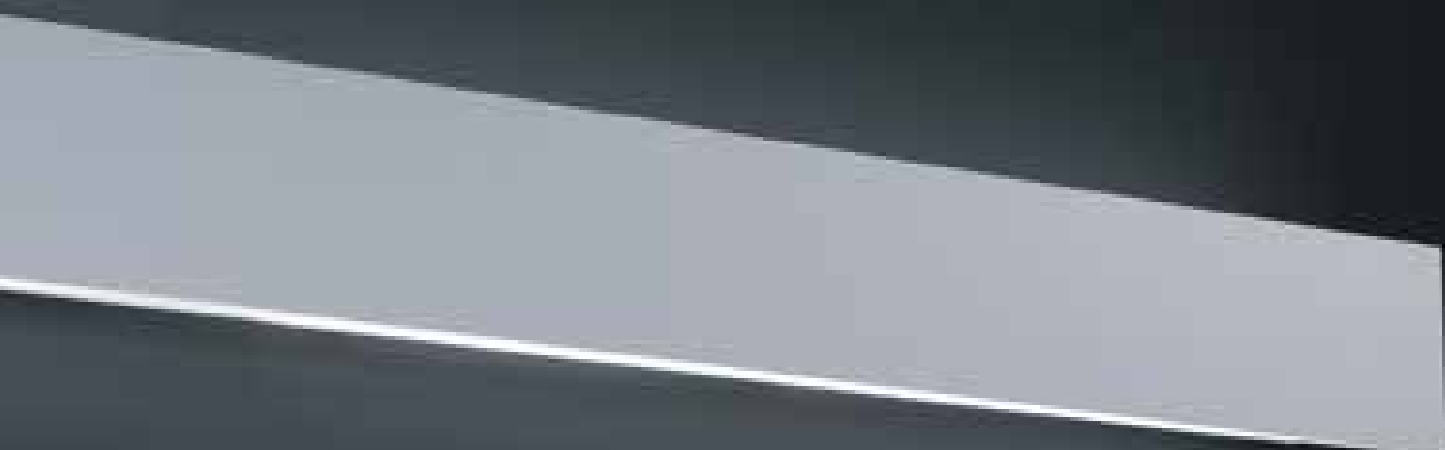

SIZE

# SIZE

## System

- › Wandsystem
- › Acrylprofil satiniert mit Frontabdeckung Aluminium eloxiert
- › Passgenaue LED und T16 Leuchteneinheiten in unterschiedlichen Längen
- › Werkzeuglose Montage der Leuchteneinheiten im Acrylprofil
- › Lichtverteilung indirekt
- › Energieeffiziente Low-Power-LEDs



## System

- › Wall system
- › Acrylic profile satinised with front cover aluminium anodised
- › Matching LED and T16 lighting units in several different lengths
- › Tool-free assembly of the lighting units in the acrylic profile
- › Indirect light distribution
- › Energy-efficient low power LEDs



**Acrylprofil satiniert mit Frontabdeckung Aluminium eloxiert L max. 3.000 mm**  
 Acrylic profile satinised with front cover aluminium anodised L max. 3.000 mm

**138-001-200-xxxx (mm)**

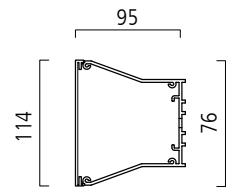

Bitte ergänzen Sie die Artikelnummer mit der gewünschten Profillänge: L = xxxx (mm). Die Profillänge errechnet sich aus der Addition der LED oder T16-Leuchteneinheiten. Die erforderlichen Leuchteneinheiten bitte separat bestellen.

Please complete the article number with the length of the profile: L = xxxx (mm). The profile length is calculated by adding the lengths of the LED or T16 lighting units. Please order the lighting units separately.

## Zubehör / Accessories



### 2 Enddeckel

2 End caps  
 silber grau / silver grey  
**138-801-200**

für Wand zu Wand Installation, silber grau  
 for wall to wall installation, silver grey  
**138-802-200**

### Linienverbinder

Line connector  
**138-800-200**



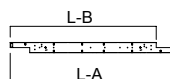
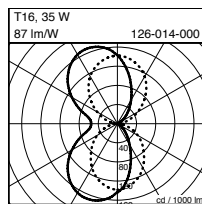
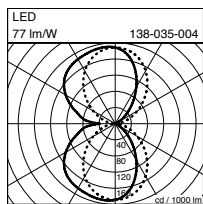

**Leuchteneinheit T16 mit 5 poliger Durchgangsverdrahtung , diagonal überlappend**  
 Lighting unit T16 with 5 pole electrical connection, diagonally overlapping



L-A	L-B	T16	ON/OFF	DIM 1-10V	DIM DALI	kg
580mm	495mm	1 x T16, 14/24W	<b>126-011-000</b>	<b>126-011-010</b>	<b>126-011-020</b>	0,8
880mm	770mm	1 x T16, 21/39W	<b>126-012-000</b>	<b>126-012-010</b>	<b>126-012-020</b>	1,0
1.180mm	1.070mm	1 x T16, 28/54W	<b>126-013-000</b>	<b>126-013-010</b>	<b>126-013-020</b>	1,3
1.480mm	1.370mm	1 x T16, 35/49W	<b>126-014-000</b>	<b>126-014-010</b>	<b>126-014-020</b>	1,5

**Leuchteneinheit T16 für Einzelleuchten, gerade**  
 Lighting unit T16 for single luminaires, straight

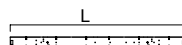

L	T16	ON/OFF	DIM 1-10V	DIM DALI	KG
880mm	1 x T16, 21/39W	<b>126-040-000</b>	<b>126-040-010</b>	<b>126-040-020</b>	1,0
1.180mm	1 x T16, 28/54W	<b>126-041-000</b>	<b>126-041-010</b>	<b>126-041-020</b>	1,3
1.480mm	1 x T16, 35/49W	<b>126-042-000</b>	<b>126-042-010</b>	<b>126-042-020</b>	1,5

**Leuchteneinheit LED mit 5 poliger Durchgangsverdrahtung**  
 (LED Leistung ca. 2400 lm/m) Ra > 80

Lighting unit LED with 5 pole electrical connection  
 (LED power appr. 2400 lm/m) Ra > 80

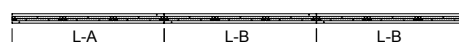
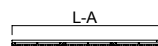

L-A	L-B	W	lm/W	3000K		lm/W	4000K		kg
				ON/OFF	DIM DALI		ON/OFF	DIM DALI	
850 mm	841mm	16	65	<b>138-021-003</b>	<b>138-021-023</b>	67	<b>138-021-004</b>	<b>138-021-024</b>	1,2
980 mm	971mm	18	67	<b>138-022-003</b>	<b>138-022-023</b>	69	<b>138-022-004</b>	<b>138-022-024</b>	1,3
1.130 mm	1.121mm	20	69	<b>138-023-003</b>	<b>138-023-023</b>	71	<b>138-023-004</b>	<b>138-023-024</b>	1,5
1.410 mm	1.401mm	25	69	<b>138-024-003</b>	<b>138-024-023</b>	71	<b>138-024-004</b>	<b>138-024-024</b>	1,9
1.690 mm	1.681mm	29	71	<b>138-025-003</b>	<b>138-025-023</b>	74	<b>138-025-004</b>	<b>138-025-024</b>	2,3

**Leuchteneinheit LED mit 5 poliger Durchgangsverdrahtung**  
 (LED Leistung ca. 4300 lm/m) Ra > 80

Lighting unit LED with 5 pole electrical connection  
 (LED power appr. 4300 lm/m) Ra > 80



L-A	L-B	W	lm/W	3000K		lm/W	4000K		kg
				ON/OFF	DIM DALI		ON/OFF	DIM DALI	
850 mm	841mm	27	70	<b>138-031-003</b>	<b>138-031-023</b>	73	<b>138-031-004</b>	<b>138-031-024</b>	1,2
980 mm	971mm	31	71	<b>138-032-003</b>	<b>138-032-023</b>	74	<b>138-032-004</b>	<b>138-032-024</b>	1,3
1.130 mm	1.121mm	35	72	<b>138-033-003</b>	<b>138-033-023</b>	75	<b>138-033-004</b>	<b>138-033-024</b>	1,5
1.410 mm	1.401mm	43	73	<b>138-034-003</b>	<b>138-034-023</b>	76	<b>138-034-004</b>	<b>138-034-024</b>	1,9
1.690 mm	1.681mm	51	74	<b>138-035-003</b>	<b>138-035-023</b>	77	<b>138-035-004</b>	<b>138-035-024</b>	2,3



Flächenbündigkeit als großes Gestaltungsthema in der Architektur findet sich auch in neuen Leuchtenkonzepten wieder. TZ-T fügt sich nahtlos in abgehängte Decken – Beleuchtung findet so nicht mehr vor Wand oder Decke statt, sondern wird in die Architektur integriert. Der rahmenlose Einbau bietet ein Höchstmaß an Reduktion und gestalterischer Perfektion, ebenso ist aber auch ein Einbau mit Rahmen möglich.

Recessed installation as a major design topic is also reflected in new lighting concepts. The TZ-T fits seamlessly into suspended ceilings – the illumination is no longer in front of the wall or ceiling but is integrated into the architecture. The frameless installation offers a maximum degree of reduction to stylistic perfection, but it can just as well be installed with a frame.



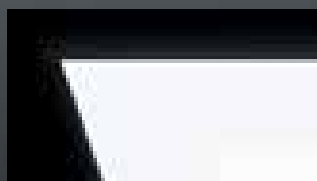
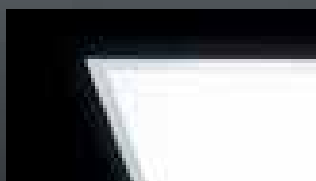
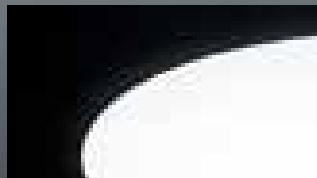
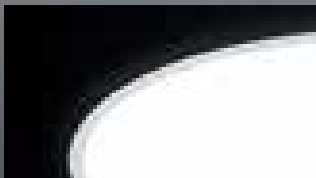

TZ-T





TZ-T

# TZ-T | TZ-T LED

## Deckenleuchte

- › Einbauleuchte für den randlosen Einbau in Gipskartondecken
- › Metall-Einbaugehäuse, weiß
- › Abdeckung opal für homogene Ausleuchtung
- › Lichtverteilung direkt
- › Energieeffiziente Leuchtstofflampen oder Low-Power-LEDs
- ›  XXX-E01 = Leuchte mit Notlicht (Batterie 3h), weitere Notlichtvarianten auf Anfrage möglich

LED IP20

## Ceiling light

- › Frameless recessed light fixture for seamless installation in plasterboard ceilings
- › Metal plaster-in housing, white
- › Cover opal for uniform illumination
- › Direct light distribution
- › Energy-efficient fluorescent lights or low-power LEDs
- ›  XXX-E01 = lamp with emergency light (battery 3H), other emergency light variants available on request

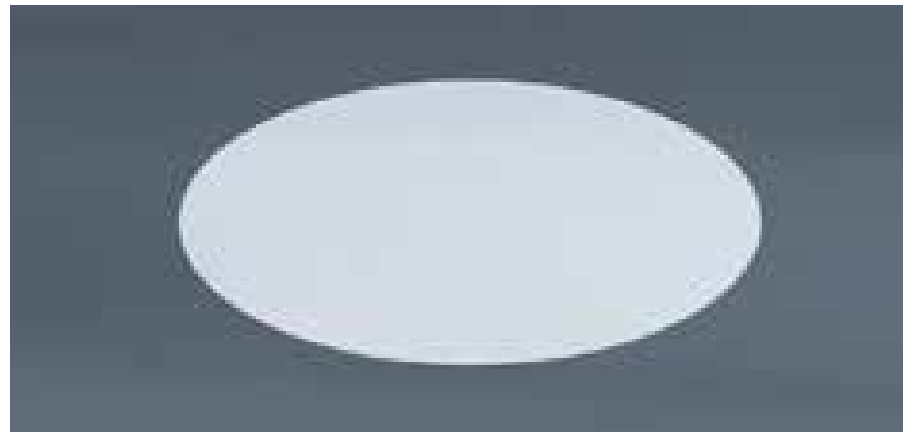

## TZ-T

### Ø 220 x 125 mm

1 x TC-F, 18 W, 2GX10 3,0 kg

**15337.14** ON/OFF

**15337.141** DIM 1-10V

**15337.142** DIM DALI

[Einbaugehäuse / Plaster-in housing](#)

**122-013-100**

### Ø 350 x 100 mm

1 x T16-R, 22 W, 2GX13 +

1 x T16-R, 40 W, 2GX13 5,0 kg

**25334.14** ON/OFF

**25334.141** DIM 1-10V

**25334.142** DIM DALI

[Einbaugehäuse / Plaster-in housing](#)

**122-014-100**

### Ø 450 x 125 mm

1 x T16-R, 22 W, 2GX13 +

1 x T16-R, 40 W, 2GX13 8,0 kg

**25331.14** ON/OFF

**25331.141** DIM 1-10V

**25331.142** DIM DALI

[Einbaugehäuse / Plaster-in housing](#)

**122-015-100**

## TZ-T LED

### Ø 220 x 125 mm

3000 K, 14 W, 61 lm/W, Ra > 80 3,5 kg

**122-012-103** ON/OFF

**122-012-123** DIM DALI

4000 K, 14 W, 65 lm/W, Ra > 80 3,5 kg

**122-012-104** ON/OFF

**122-012-124** DIM DALI

[Einbaugehäuse / Plaster-in housing](#)

**122-013-100**

### Ø 350 x 100 mm

3000 K, 18 W, 68 lm/W, Ra > 80 5,5 kg

**122-001-103** ON/OFF

**122-001-123** DIM DALI

4000 K, 18 W, 73 lm/W, Ra > 80 5,5 kg

**122-001-104** ON/OFF

**122-001-124** DIM DALI

[Einbaugehäuse / Plaster-in housing](#)

**122-014-100**

### Ø 450 x 125 mm

3000 K, 31 W, 70 lm/W, Ra > 80 8,0 kg

**122-002-103** ON/OFF 

**122-002-123** DIM DALI 

4000 K, 31 W, 76 lm/W, Ra > 80 8,0 kg

**122-002-104** ON/OFF 

**122-002-124** DIM DALI 

3000 K, 46 W, 71 lm/W, Ra > 80 8,0 kg

**122-022-103** ON/OFF 

**122-022-123** DIM DALI 

4000 K, 46 W, 75 lm/W, Ra > 80 8,0 kg

**122-022-104** ON/OFF 

**122-022-124** DIM DALI 

[Einbaugehäuse / Plaster-in housing](#)

**122-015-100**

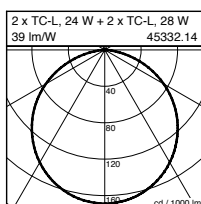
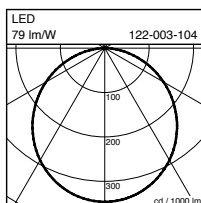
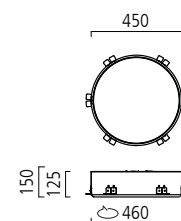
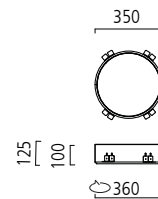
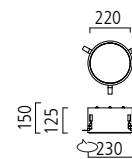

**Einbauleuchte und Einbaugehäuse bitte separat bestellen.**

Please order the lighting unit and plaster-in housing separately.

## TZ-T

### Ø 650 x 125 mm

2 x TC-L, 24 W, 2G11 +

2 x TC-L, 28 W, 2GX11 13,5 kg

<b>45332.14</b>	ON/OFF
<b>45332.141</b>	DIM 1-10V
<b>45332.142</b>	DIM DALI

Einbaugehäuse / Plaster-in housing

**122-016-100**

### Ø 950 x 125 mm

4 x T16, 14/24 W, G5 +

2 x T16, 21/39 W, G5 25,0 kg

<b>65333.14</b>	ON/OFF
<b>65333.141</b>	DIM 1-10V
<b>65333.142</b>	DIM DALI



Einbaugehäuse / Plaster-in housing

**122-017-100**



## TZ-T LED

### Ø 650 x 125 mm

3000 K, 62 W, 73 lm/W, Ra > 80 13,5 kg

<b>122-003-103</b>	ON/OFF	
<b>122-003-123</b>	DIM DALI	

4000 K, 62 W, 79 lm/W, Ra > 80 13,5 kg



<b>122-003-104</b>	ON/OFF	
<b>122-003-124</b>	DIM DALI	

Einbaugehäuse / Plaster-in housing



**122-016-100**

### Ø 950 x 125 mm

3000 K, 117 W, 71 lm/W, Ra > 80 25,0 kg

<b>122-004-103</b>	ON/OFF	
<b>122-004-123</b>	DIM DALI	

4000 K, 117 W, 77 lm/W, Ra > 80 25,0 kg

<b>122-004-104</b>	ON/OFF	
<b>122-004-124</b>	DIM DALI	

Einbaugehäuse / Plaster-in housing

**122-017-100**

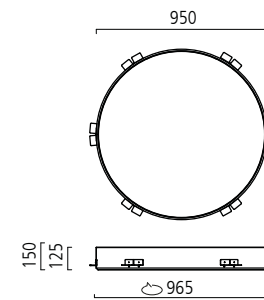
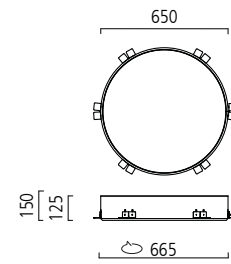

# TZ-T | TZ-T LED

## Deckenleuchte

- › Einbauleuchte für den randlosen Einbau in Gipskartondecken
- › Metall-Einbaugehäuse, weiß
- › Abdeckung opal für homogene Ausleuchtung
- › Lichtverteilung direkt
- › Energieeffiziente T16-Leuchtstofflampen oder Low-Power-LEDs
- ›  XXX-E01 = Leuchte mit Notlicht (Batterie 3h), weitere Notlichtvarianten auf Anfrage möglich

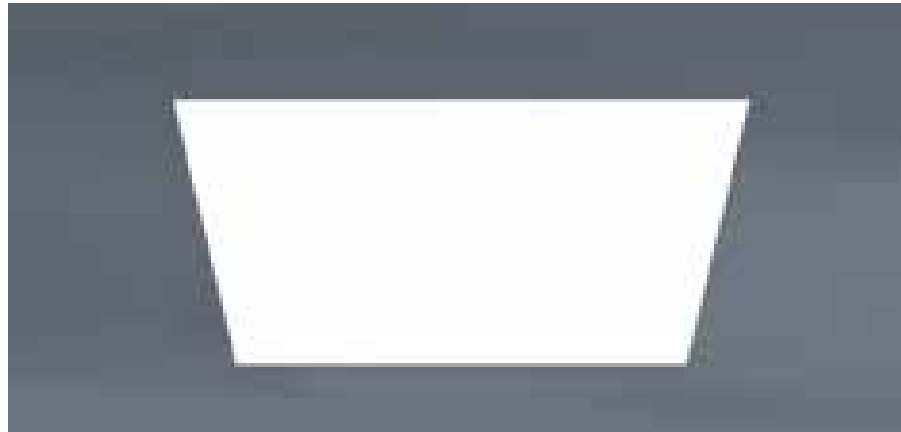

LED IP20

## Ceiling light

- › Frameless recessed light fixture for seamless installation in plasterboard ceilings
- › Metal plaster-in housing, white
- › Cover opal for uniform illumination
- › Direct light distribution
- › Energy-efficient T16 fluorescent lights or low-power LEDs
- ›  XXX-E01 = lamp with emergency light (battery 3H), other emergency light variants available on request

## TZ-T

### 337 x 337 x 100 mm

1 x T16-R, 22 W, 2GX13 +  
1 x T16-R, 40 W, 2GX13 4,4 kg

**122-005-100** ON/OFF  
**122-005-110** DIM 1-10V  
**122-005-120** DIM DALI

[Einbaugehäuse / Plaster-in housing](#)

**122-018-100**

### 460 x 460 x 125 mm

1 x T16-R, 22 W, 2GX13 +  
1 x T16-R, 40 W, 2GX13 8,0 kg

**122-006-100** ON/OFF  
**122-006-110** DIM 1-10V  
**122-006-120** DIM DALI

[Einbaugehäuse / Plaster-in housing](#)

**122-019-100**

### 630 x 630 x 125 mm

4 x T16, 14/24 W, G5 13,9 kg

**122-007-100** ON/OFF  
**122-007-110** DIM 1-10V  
**122-007-120** DIM DALI

[Einbaugehäuse / Plaster-in housing](#)

**122-020-100**

### 920 x 920 x 125 mm

6 x T16, 21/39 W, G5 25,5 kg



**122-008-100** ON/OFF  
**122-008-110** DIM 1-10V  
**122-008-120** DIM DALI

[Einbaugehäuse / Plaster-in housing](#)

**122-021-100**

## TZ-T LED

### 337 x 337 x 100 mm



3000 K, 12 W, 88 lm/W, Ra > 80 4,4 kg  
**122-009-103** ON/OFF   
**122-009-123** DIM DALI 



4000 K, 12 W, 91 lm/W, Ra > 80 4,4 kg  
**122-009-104** ON/OFF   
**122-009-124** DIM DALI 

[Einbaugehäuse / Plaster-in housing](#)

**122-018-100**

### 460 x 460 x 125 mm

3000 K, 33 W, 84 lm/W, Ra > 80 6,8 kg  
**122-023-103** ON/OFF   
**122-023-123** DIM DALI 



4000 K, 33 W, 89 lm/W, Ra > 80 6,8 kg  
**122-023-104** ON/OFF   
**122-023-124** DIM DALI 



[Einbaugehäuse / Plaster-in housing](#)

**122-019-100**

### 630 x 630 x 125 mm

3000 K, 43 W, 98 lm/W, Ra > 80 13,9 kg

**122-010-103** ON/OFF   
**122-010-123** DIM DALI   
4000 K, 43 W, 101 lm/W, Ra > 80 13,9 kg



**122-010-104** ON/OFF   
**122-010-124** DIM DALI 



[Einbaugehäuse / Plaster-in housing](#)

**122-020-100**

### 920 x 920 x 125 mm

3000 K, 94 W, 101 lm/W, Ra > 80 25,5 kg

**122-011-103** ON/OFF   
**122-011-123** DIM DALI   
4000 K, 94 W, 104 lm/W, Ra > 80 25,5 kg

**122-011-104** ON/OFF   
**122-011-124** DIM DALI 

[Einbaugehäuse / Plaster-in housing](#)

**122-021-100**

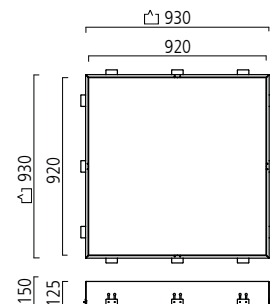
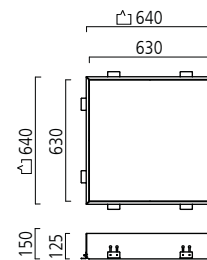
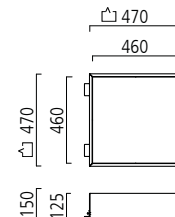
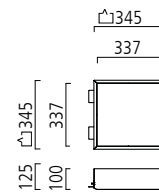
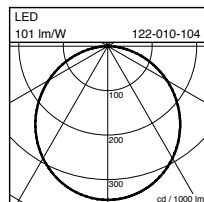
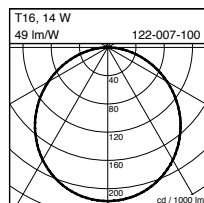

**Einbauleuchte und Einbaugehäuse bitte separat bestellen.**  
Please order the lighting unit light and plaster-in housing separately.



# TZ-T | TZ-T LED

## Deckenleuchte

- › Einbauleuchte mit Einbau-rahmen für den Einbau in Gipskartondecken
- › Metall-Einbaugehäuse, weiß
- › Abdeckung opal für homogene Ausleuchtung
- › Lichtverteilung direkt
- › Energieeffiziente Leuchtstofflampen oder Low-Power-LEDs
- ›  XXX-E01 = Leuchte mit Notlicht (Batterie 3h), weitere Notlichtvarianten auf Anfrage möglich



LED IP20

## Ceiling light

- › Recessed light fixture with mounting frame for installation in plasterboard ceilings
- › Metal plaster-in housing, white
- › Cover opal for uniform illumination
- › Direct light distribution
- › Energy-efficient fluorescent lights or low-power LEDs
- ›  XXX-E01 = lamp with emergency light (battery 3H), other emergency light variants available on request

## TZ-T

**Ø 236 x 125 mm**  
1 x TC-F, 18 W, 2G10 3,4 kg

**122-024-100** ON/OFF  
**122-024-120** DIM DALI

**Ø 370 x 130 mm**  
1 x T16-R, 22 W, 2GX13 +  
1 x T16-R, 40 W, 2GX13 5,9 kg

**122-025-100** ON/OFF  
**122-025-120** DIM DALI

**Ø 470 x 150 mm**  
1 x T16-R, 22 W, 2GX13 +  
1 x T16-R, 40 W, 2GX13 8,4 kg

**122-026-100** ON/OFF  
**122-026-120** DIM DALI

**Ø 672 x 150 mm**  
2 x TC-L, 24 W, 2G11 +  
2 x TC-L, 28 W, 2GX11 13,9 kg

**122-027-100** ON/OFF  
**122-027-120** DIM DALI

**Ø 972 x 150 mm**  
4 x T16, 14/24 W, G5 +  
2 x T16, 21/39 W, G5 25,4 kg

**122-028-100** ON/OFF  
**122-028-120** DIM DALI

## TZ-T LED





**Ø 236 x 125 mm**  
3000 K, 14 W, 61 lm/W, Ra > 80 3,9 kg

**122-033-103** ON/OFF  
**122-033-123** DIM DALI  
4000 K, 14 W, 65 lm/W, Ra > 80 3,9 kg  
**122-033-104** ON/OFF  
**122-033-124** DIM DALI





**Ø 370 x 130 mm**  
3000 K, 18 W, 68 lm/W, Ra > 80 5,9 kg

**122-034-103** ON/OFF  
**122-034-123** DIM DALI  
4000 K, 18 W, 73 lm/W, Ra > 80 5,9 kg  
**122-034-104** ON/OFF  
**122-034-124** DIM DALI





**Ø 470 x 150 mm**  
3000 K, 31 W, 70 lm/W, Ra > 80 8,4 kg

**122-035-103** ON/OFF   
**122-035-123** DIM DALI   
4000 K, 31 W, 76 lm/W, Ra > 80 8,4 kg  
**122-035-104** ON/OFF   
**122-035-124** DIM DALI 





3000 K, 46 W, 71 lm/W, Ra > 80 8,4 kg

**122-036-103** ON/OFF   
**122-036-123** DIM DALI   
4000 K, 46 W, 75 lm/W, Ra > 80 8,4 kg  
**122-036-104** ON/OFF   
**122-036-124** DIM DALI 

**Ø 672 x 150 mm**  
3000 K, 62 W, 73 lm/W, Ra > 80 13,9 kg

**122-037-103** ON/OFF   
**122-037-123** DIM DALI   
4000 K, 62 W, 79 lm/W, Ra > 80 13,9 kg  
**122-037-104** ON/OFF   
**122-037-124** DIM DALI 

**Ø 972 x 150 mm**  
3000 K, 117 W, 71 lm/W, Ra > 80 25,4 kg

**122-038-103** ON/OFF   
**122-038-123** DIM DALI   
4000 K, 117 W, 77 lm/W, Ra > 80 25,4 kg  
**122-038-104** ON/OFF   
**122-038-124** DIM DALI 

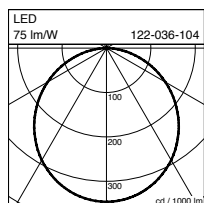
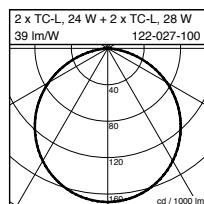
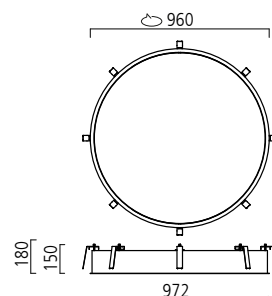
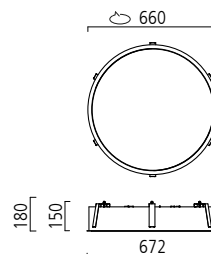
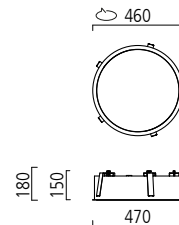
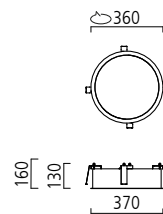
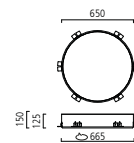



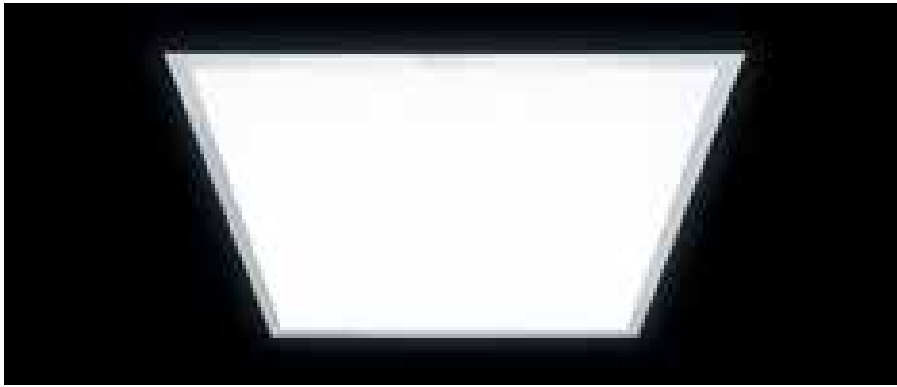

## TZ-T

### 353 x 353 x 130 mm

1 x T16-R, 22 W, 2GX13 +	
1 x T16-R, 40 W, 2GX13	4,8 kg
<b>122-029-100</b>	ON/OFF
<b>122-029-120</b>	DIM DALI

### 477 x 477 x 150 mm

1 x T16-R, 22 W, 2GX13 +	
1 x T16-R, 40 W, 2GX13	8,4 kg
<b>122-030-100</b>	ON/OFF
<b>122-030-120</b>	DIM DALI

### 647 x 647 x 150 mm

4 x T16, 14/24 W, G5	14,3 kg
<b>122-031-100</b>	ON/OFF
<b>122-031-120</b>	DIM DALI

### 938 x 938 x 150 mm

6 x T16, 21/39 W, G5	25,9 kg
<b>122-032-100</b>	ON/OFF
<b>122-032-120</b>	DIM DALI

## TZ-T LED

### 353 x 353 x 130 mm

3000 K, 12 W, 88 lm/W, Ra > 80	4,8 kg	
<b>122-039-103</b>	ON/OFF	
<b>122-039-123</b>	DIM DALI	
4000 K, 12 W, 91 lm/W, Ra > 80	4,8 kg	
<b>122-039-104</b>	ON/OFF	
<b>122-039-124</b>	DIM DALI	

### 477 x 477 x 150 mm

3000 K, 33 W, 84 lm/W, Ra > 80	7,2 kg	
<b>122-040-103</b>	ON/OFF	
<b>122-040-123</b>	DIM DALI	
4000 K, 33 W, 89 lm/W, Ra > 80	7,2 kg	
<b>122-040-104</b>	ON/OFF	
<b>122-040-124</b>	DIM DALI	

### 647 x 647 x 150 mm

3000 K, 43 W, 98 lm/W, Ra > 80	14,3 kg	
<b>122-041-103</b>	ON/OFF	
<b>122-041-123</b>	DIM DALI	
4000 K, 43 W, 101 lm/W, Ra > 80	14,3 kg	
<b>122-041-104</b>	ON/OFF	
<b>122-041-124</b>	DIM DALI	

### 938 x 938 x 150 mm

3000 K, 94 W, 101 lm/W, Ra > 80	25,9 kg	
<b>122-042-103</b>	ON/OFF	
<b>122-042-123</b>	DIM DALI	
4000 K, 94 W, 104 lm/W, Ra > 80	25,9 kg	
<b>122-042-104</b>	ON/OFF	
<b>122-042-124</b>	DIM DALI	

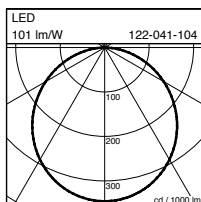
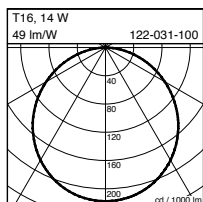
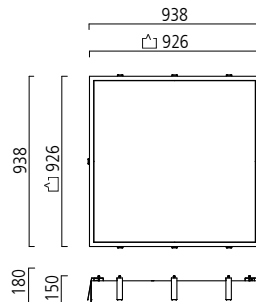
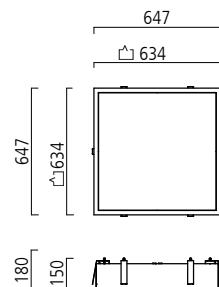
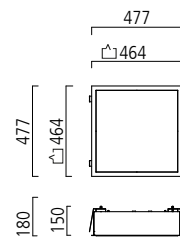
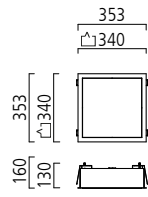



Wie beleuchtet man Funktionsräume mit abgehängter Decke ebenso einfach wie funktional? Indem man ein Deckenelement der Rasterdecke gegen eine Leuchte austauscht. Mit den passenden Abmessungen und Ausführungsvarianten erfüllt TECTO diese Anforderungen ideal und bietet eine zuverlässige sowie funktionale Beleuchtung.

How can functional rooms with suspended ceilings be illuminated both simply and functionally? By replacing one element of the ceiling grid with a light fitting. With suitable dimensions and model variants, TECTO ideally fulfils the requirements for this task, providing reliable and functional illumination.

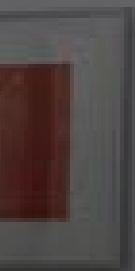

# TECTO

## Deckenleuchte

- › Einbauleuchte für Rasterdecken  
625 x 625 mm
- › oder für Gipskartondecken /  
Deckenausschnitt  
605 x 605 mm
- › Abdeckung opal oder mit  
blendreduzierender Prismatik
- › Werkzeugloser  
Leuchtmittelwechsel
- › Lichtverteilung direkt
- › Notbeleuchtung auf Anfrage



## Ceiling light

- › Recessed light for grid ceilings  
625 x 625 mm
- › or plasterboard ceilings,  
cut-out 605 x 605 mm
- › Cover opal or glare reduced  
prismatic cover
- › Tool-free change of bulbs
- › Direct light distribution
- › Emergency lighting on request



### PUBLIC

Mit Abdeckung opal  
With cover opal

**625 x 625 x 110 mm**  
4 x T16, 14/24 W, G5 10,2 kg

- 45174.07** ON/OFF
- 45174.071** DIM 1-10V
- 45174.072** DIM DALI

### OFFICE

Mit blendreduzierender Prismatik  
With glare reducing prismatic cover

**625 x 625 x 110 mm**  
4 x T16, 14/24 W, G5 10,2 kg

- 45173.07** ON/OFF
- 45173.071** DIM 1-10V
- 45173.072** DIM DALI

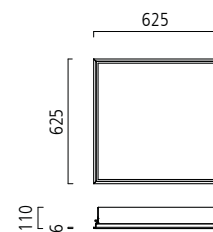
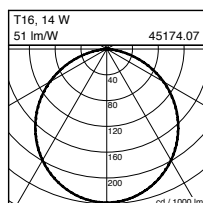
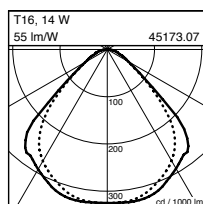





Mit den vorgefertigten Gipsmodulen der Einbauleuchte TZ-4 lassen sich Gipskartondecken oder -wände modern und kreativ gestalten. Wahlweise rund oder eckig und mit der charakteristischen hinterleuchteten Abdeckung und weichen Kontur setzen sie als Reihe oder flächiges Raster einen besonderen Akzent in Fluren, Entrees oder großen Räumen.

The prefabricated plaster modules of the TZ-4 recessed luminaires enable modern, creative design of plasterboard ceilings or walls. Either round or angular and with their characteristic backlit cover and soft contours, they create special highlights in corridors, entrance areas or large rooms arranged in rows or as a planar grid.



TZ-4

# TZ-4

## Wand- und Deckenleuchte

- › Einbauleuchte für Gipskarton decken und -wände
- › Deckenausschnitt 595 x 595 mm oder 620 x 620 mm
- › Abdeckung Aluminium eloxiert für blendfreie Ausleuchtung
- › Lichtverteilung indirekt
- › Notbeleuchtung auf Anfrage
- › Gipsmodul und Leuchteneinheit bitte separat bestellen



## Wall- and ceiling light

- › Recessed light for gypsum ceilings and walls
- › Ceiling cutout 595 x 595 mm or 620 x 620 mm
- › Cover aluminium anodised for glare-free illumination
- › Light distribution direct
- › Emergency lighting on request
- › Please order gypsum module and lighting unit separately

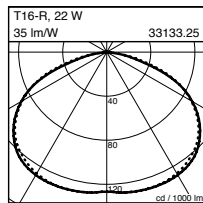
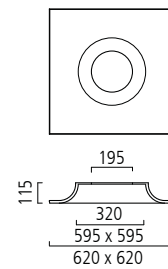
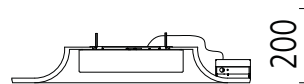

### Leuchteneinheit

Lighting unit

Ø 265 x 60 mm

1 x T16-R, 22 W, 2GX13 4,8 kg

**33133.25** ON/OFF

**33133.251** DIM 1-10V

**33133.252** DIM DALI

### Gipsmodul roh

Gypsum module unpainted

595 x 595 x 115 mm 3,2 kg

**33001.00**

620 x 620 x 115 mm 3,7 kg

**33002.00**





# TZ-4

## Wand- und Deckenleuchte

- › Einbauleuchte für Gipskartondecken und -wände
- › Deckenausschnitt 595 x 595 mm oder 620 x 620 mm
- › Abdeckung Aluminium eloxiert für blendfreie Ausleuchtung
- › Lichtverteilung indirekt
- › Notbeleuchtung auf Anfrage
- › Gipsmodul und Leuchteneinheit bitte separat bestellen



## Wall- and ceiling light

- › Recessed light for gypsum ceilings and walls
- › Ceiling cutout 595 x 595 mm or 620 x 620 mm
- › Cover aluminium anodised for glare-free illumination
- › Light distribution direct
- › Emergency lighting on request
- › Please order gypsum module and lighting unit separately

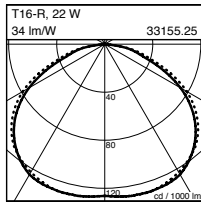
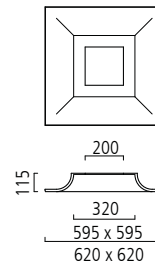
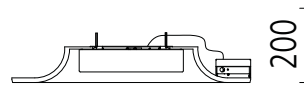

### Leuchteneinheit

Lighting unit

#### 270 x 270 x 60 mm

1 x T16-R, 22 W, 2GX13 5 kg

**33155.25** ON/OFF

**33155.251** DIM 1-10V

**33155.252** DIM DALI

### Gipsmodul roh

Gypsum module unpainted

595 x 595 x 115 mm 3,5 kg

**33003.00**

620 x 620 x 115 mm 4,0 kg

**33004.00**





Dank der zweiteiligen Gipsmodule hält scheinbar der Himmel in geschlossenen Räumen Einzug. Sie werden randlos in Gipskartondecken eingebaut. LEDs leuchten die innere Gipshaube mit weißem oder farbigem Licht homogen aus. Mit diesem Gipseinbausystem bekommen Decken mit geringem Aufwand eine neue gestalterische Dimension.

Thanks to two-part gypsum modules, the sky seems to have entered closed interiors. They are seamlessly integrated into plasterboard ceilings. LEDs illuminate the inner gypsum dome evenly with white or coloured light. This gypsum installation system gives ceilings a new dimension in design with only moderate expense.



TZ-4 LED





# TZ-4 LED

# TZ-4 LED

## Deckenleuchte

- › Einbauleuchte für Gipskartondecken
- › Bestehend aus Gipsmodulhaube und -unterteil
- › Deckenausschnitt 620 x 620 mm oder 1245 x 1245 mm
- › Lichtverteilung indirekt
- › LED weiß oder RGB
- › Wahlweise schaltbar ON/OFF oder steuerbar mit Fernbedienung



## Ceiling light

- › Recessed light for gypsum ceilings
- › Gypsum module consisting of 2 parts: Upper dome and subframe
- › Ceiling cutout 620 x 620 mm or 1245 x 1245 mm
- › Light distribution indirect
- › LED white or RGB
- › Optionally switchable ON/OFF or with radio remote control

## Zubehör / Accessories



**Netzteil, 24 V DC**  
Power supply, 24 V DC  
92242 60 W  
92267 120 W



**Funkfernbedienung**  
Radio remote control  
92245



**Funksteuergerät**  
Radio control unit  
92246



## Dimm-Modul Dim Module

**LED weiß / white**  
1-10 V, 24 V DC, max. 120 W, ohne Netzteil  
1-10 V, 24 V DC,  
max. 120 W, without power supply  
**92327**  
DALI 24 V DC, max. 120 W, ohne Netzteil  
DALI 24 V DC,  
max. 120 W, without power supply  
**92328**

**LED RGB**  
DALI 24 V DC, mit Netzteil 75 W  
DALI 24 V DC,  
including power supply 75 W  
**92329**  
DMX 24 V DC, max. 140 W, ohne Netzteil  
DMX 24 V DC,  
max. 140 W, without power supply  
**92330**

Das erforderliche Netzteil, das Dimm-Modul, die Funkfernbedienung, das Funksteuergerät bitte separat bestellen.  
Please order the necessary power supply, dim module, radio remote control and radio control unit separately.



**Gipsmodul 2-teilig inklusive LED**  
 Gypsum module 2 parts including LED

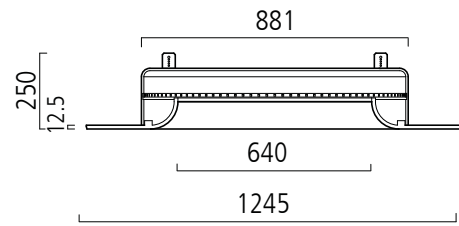
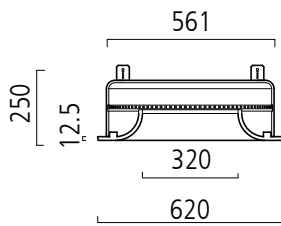

**LED weiß / white**  
 36 W, 3000 K, 41 lm/W, Ra>80  
**15543.00** ca. 620 x 620 mm 8,0 kg  
 36 W, 4000 K, 41 lm/W, Ra>80  
**15270.00** ca. 620 x 620 mm 8,0 kg

**LED RGB**  
 34 W  
**15271.00** ca. 620 x 620 mm 8,0 kg



**LED weiß / white**  
 55 W, 3000 K, 43 lm/W, Ra>80  
**15544.00** ca. 1.245 x 1.245 mm 22 kg  
 55 W, 4000 K, 43 lm/W, Ra>80  
**15272.00** ca. 1.245 x 1.245 mm 22 kg

**LED RGB**  
 51 W  
**15273.00** ca. 1.245 x 1.245 mm 22 kg



In Bodennähe eingelassen, beleuchten die Wandeinbauleuchten TZ-5 LED gezielt Böden, Flure und Treppen. Die Gipsmodule in unterschiedlichem, reduziertem Design lassen sich flächenbündig und randlos in Gipskartonwänden einbauen. Die Beleuchtung sorgt nicht nur für mehr Sicherheit, sondern bietet alle Voraussetzungen für eine effektvolle Lichtgestaltung.

Installed close to the floor, TZ-5 LED recessed wall lights provide targeted illumination for floors, corridors and stairs. The gypsum modules in varying minimalistic designs can be integrated seamlessly in plasterboard walls. This illumination not only provides added safety, but also offers extensive scope for effective lighting design.



# TZ-5 LED

# TZ-5 LED

## Wandleuchte

- › Einbauleuchte für Gipskartonwände
- › Bestehend aus Gipsmodul und LED-Einheit
- › Lichtverteilung direkt
- › Energieeffiziente LEDs



## Wall light

- › Recessed light for plasterboard walls
- › Consisting of gypsum module and LED unit
- › Indirect light distribution
- › Energy-efficient LEDs

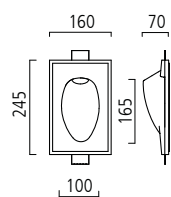

### 245 x 160 x 70 mm

3000 K, 1 W, Ra>80	0,7 kg
<b>18252.00</b>	ON/OFF
4000 K, 1 W, Ra>80	0,7 kg
<b>18257.00</b>	ON/OFF

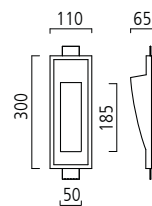

### 300 x 110 x 65 mm

3000 K, 1 W, Ra>80	1 kg
<b>18253.00</b>	ON/OFF
4000 K, 1 W, Ra>80	1 kg
<b>18259.00</b>	ON/OFF

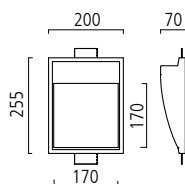

### 255 x 200 x 70 mm

3000 K, 1 W, Ra>80	1,3 kg
<b>18254.00</b>	ON/OFF
4000 K, 1 W, Ra>80	1,3 kg
<b>18258.00</b>	ON/OFF





Das klassische Downlight bekommt durch das Gipsmodul zum randlosen Einbau in Gipskartondecken buchstäblich eine neue Dimension – je nach Ausführung als Vertiefung oder Ausstülpung in der Decke. Die dreh- und schwenkbare Leuchteneinheit und die direkte Lichtverteilung sorgen für bedarfsgerechte Beleuchtung. Unterschiedliche Formen, Größen und Bestückungen schaffen gestalterische Flexibilität.

With its gypsum module for seamless installation in plasterboard ceilings, the classic downlight literally takes up a new dimension as a recess or protrusion in the ceiling, depending on the mode of installation. Its rotatable and tiltable luminaire and direct light distribution ensure appropriate lighting. A choice of different forms, sizes and luminants provides creative flexibility.



TZ-6







TZ-6

# TZ-6

## Deckenleuchte

- › Einbauleuchte für Gipskartondecken
- › Gipsmodul mit Kardanringen
- › Einsatz von SCHMITZ LED Modulen oder Halogenleuchtmitteln möglich
- › Dreh- und schwenkbar
- › Lichtverteilung direkt
- › Das erforderliche Zubehör bitte separat bestellen



## Ceiling light

- › Integrated light for plasterboard ceilings
- › Gypsum module with gimbals
- › For use with SCHMITZ LED modules or halogen lamps
- › Rotatable and tiltable
- › Direct light distribution
- › Please order the necessary accessories separately

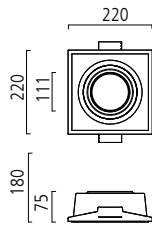

**220 x 220 x 75 mm**

1 x LED 13 W oder / or  
 1 x QR-LP111 max. 50 W, G53 1,3 kg  
**15264.00**

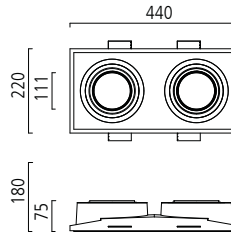

**440 x 220 x 75 mm**

2 x LED 13 W oder / or  
 2 x QR-LP111 max. 50 W, G53 2,9 kg  
**25266.00**

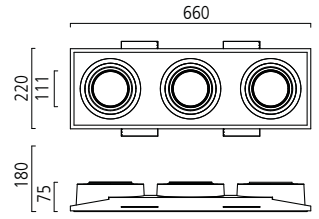

**660 x 220 x 75 mm**

3 x LED 13 W oder / or  
 3 x QR-LP111 max. 50 W, G53 4,7 kg  
**35268.00**

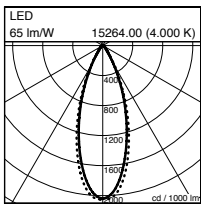

## SCHMITZ LED Module SCHMITZ LED modules

### LED Module

LED modules

3000 K, 13 W, 925 lm, 40°, RA > 92

**141-801-003**

4000 K, 13 W, 975 lm, 40°, RA > 92

**141-801-004**

### Netzteile

Power supplies

**92269** ON/OFF (1 module)

**92270** ON/OFF (2/3 modules)

**92271** DIM DALI (1 module)

**92272** DIM DALI (2/3 modules)

LED Einsätze oder Halogenleuchtmittel möglich. Treiber immer separat auswählen.

LED units or halogen lamps possible. Always choose driver separately.

## Zubehör für QR-LP111 Leuchtmittel Accessories for QR-LP111 lamps



### Trafo

Power supply

**92257** 35-105 VA

**92258** 50-105 VA



### Zuleitung komplett für QR-LP111

Supply line complete for QR-LP111

**92259**



# TZ-6

## Deckenleuchte

- › Einbauleuchte für Gipskartondecken
- › Gipsmodul mit Kardanringen
- › Einsatz von SCHMITZ LED Modulen oder Halogenleuchtmitteln möglich
- › Dreh- und schwenkbar
- › Lichtverteilung direkt
- › Das erforderliche Zubehör bitte separat bestellen



## Ceiling light

- › Integrated light for plasterboard ceilings
- › Gypsum module with gimbals
- › For use with SCHMITZ LED modules or halogen lamps
- › Rotatable and tiltable
- › Direct light distribution
- › Please order the necessary accessories separately

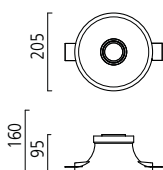

Ø 205 x 95 mm

1 x QR-CBC51, 35/50 W, GU5,3 0,8 kg  
**15289.00**

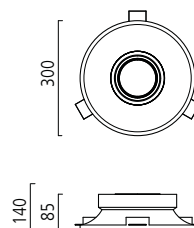
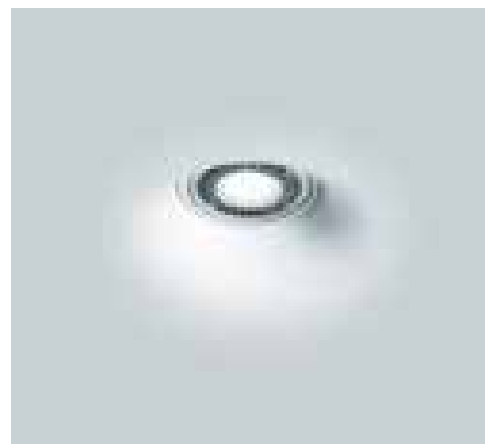

Ø 300 x 85 mm

1 x LED 13 W oder / or  
 1 x QR-LP111 max. 50 W, G53 2,0 kg  
**15290.00**

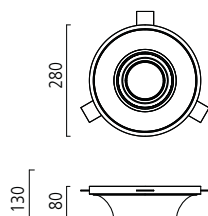
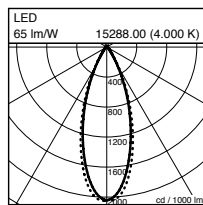
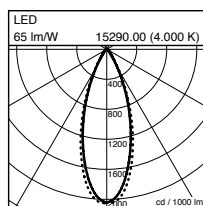

Ø 280 x 80 mm

1 x LED 13 W oder / or  
 1 x QR-LP111 max. 50 W, G53 1,8 kg  
**15288.00**

LED Einsätze oder Halogenleuchtmittel möglich. Treiber immer separat auswählen.

LED units or halogen lamps possible. Always choose driver separately.

Seite / page 246



# TZ-6

## Deckenleuchte

- › Einbauleuchte für Gipskartondecken
- › Gipsmodul inklusive Leuchteneinheit
- › Abdeckung opal für homogene Ausleuchtung
- › Lichtverteilung direkt



## Ceiling light

- › Integrated light for plasterboard ceilings
- › Gypsum module including lighting unit
- › Cover opal for uniform illumination
- › Direct light distribution



**Ø 335 x 165 mm**

2 x TC-DEL, 26 W, G24q-3 2,8 kg

**25291.00** ON/OFF

**25291.001** DIM 1-10V

**25291.002** DIM DALI

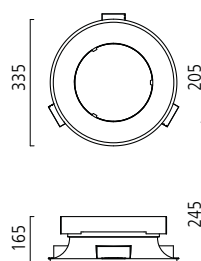

**Ø 360 x 165 mm**

2 x TC-DEL, 26 W, G24q-3 3 kg

**25286.00** ON/OFF

**25286.001** DIM 1-10V

**25286.002** DIM DALI

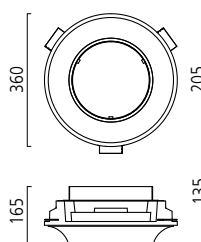





Der Gipseinbaukanal mit abgerundeten seitlichen Kanten verleiht der linearen Beleuchtung einen sanften Touch. Er wird bündig in die Gipskartondecke eingebaut, die passgenaue Leuchte – optional mit T16 Leuchtstofflampe oder LED bestückt – verschwindet komplett hinter der satinierten oder prismatischen Acrylabdeckung. Wie alle linearen Beleuchtungssysteme, ist auch TZ-50 | TZ-51 in der Länge absolut flexibel.

The gypsum installation channel with rounded lateral edges gives this linear light a soft touch. Recessed into the plasterboard ceiling, the tight-fitting luminaire – equipped as desired either with a T16 fluorescent tube or with LEDs – disappears completely behind the satinised or prismatic acrylic cover. As applies to all linear lighting systems, TZ-50 | TZ-51 is also absolutely flexible in length.





TZ-50 | TZ-51

# TZ-50 | TZ-51

## System

- › Einbaukanal aus Gipskarton für den randlosen Einbau in Gipskartondecken und -wände
- › Passgenaue LED / T16 Leuchteneinheiten in unterschiedlichen Längen
- › Wahlweise satinierte Abdeckung PUBLIC oder blendfreie Optik OFFICE
- › Werkzeuglose Montage der Leuchteneinheiten im Aluminiumprofil
- › Lichtverteilung direkt
- › Energieeffiziente Low-Power-LEDs

## Einbaukanal aus Gips / Recessed mounting channel made of gypsum



TZ-50

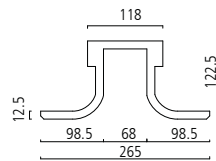

<b>44001.00</b>	1.000 mm	5,8 kg
<b>44002.00</b>	2.000 mm	11,8 kg

TZ-51

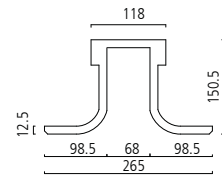

<b>44003.00</b>	1.000 mm	6,0 kg
<b>44004.00</b>	2.000 mm	12,0 kg



## System

- › Recessed gypsum mounting channel for seamless integration in plasterboard ceilings or walls
- › Matching LED / T16 lighting units in several different lengths
- › Choice between satinised cover PUBLIC and glare-free OFFICE optic
- › Tool-free assembly of the lighting units in the aluminium profile
- › Direct light distribution
- › Energy-efficient low power LEDs

## Aluminiumprofil (L max. 3.000 mm) weiß / Aluminium profile (L max. 3.000 mm) white

TZ-50

126-002-100-xxxx (mm)

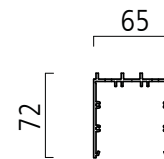

TZ-51

126-003-100-xxxx (mm)

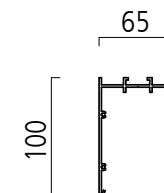

### Leuchteneinheiten, Bestellbeispiel und Schnellrechentabellen:

Lighting units, order example and easy planning guide:

Seite / page 272 - 275

Gipskanal, Aluminiumprofil, Zubehör + Leuchteneinheit bitte separat bestellen

Please order the gypsum channel, aluminium profile, accessories + lighting units separately

Bitte ergänzen Sie die Artikelnummer mit der gewünschten Profillänge: L = xxxx (mm).  
Please complete the article number with the length of the profile: L = xxxx (mm).

## Zubehör / Accessories

Bitte ergänzen Sie die Artikelnummer mit der gewünschten Acryllänge/Abdeckungslänge: L = xxxx (mm)

Please complete the article number with the length of acrylic/blank element: L = xxxx (mm)



**PUBLIC**  
**Acrylabdeckung satiniert**  
 Acrylic cover satinised  
 L max. 3.000 mm  
**126-820-000-xxxx (mm) T16**  
**126-850-000-xxxx (mm) LED**



**OFFICE**  
**Prismatische Abdeckung**  
 Prismatic diffuser  
 L max. 3.000 mm  
**126-821-000-xxxx (mm) T16**  
**126-851-000-xxxx (mm) LED**

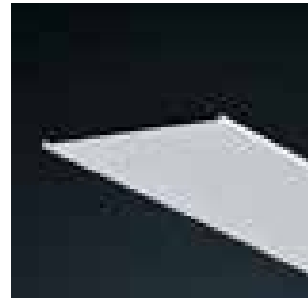

**Blindabdeckung**  
 Blank element  
 L max. 3.000 mm  
 weiß / white  
**126-822-100-xxxx (mm)**

Acrylabdeckungen werden grundsätzlich abzüglich Ausdehnungsfaktor geliefert  
 Acrylic covers are generally supplied less expansion factor



**Eckverbinder 90° inkl. Verbinder**  
 Angle connector 90° incl. connector  
 200 x 200 mm / weiß, white  
**TZ-50**  

---

**PUBLIC**  
 inkl. Acrylabdeckung satiniert  
 incl. acrylic cover satinised  
**126-802-100**  
**OFFICE**  
 inkl. prismatischer Abdeckung  
 incl. prismatic diffuser  
**126-833-100**



**Linienverbinder**  
 Line connector  
**TZ-50**  

---

**126-806-000**  
**TZ-51**  

---

**126-807-000**



**2 Enddeckel**  
 2 End caps  
 Tiefe, depth 2 mm / weiß, white  
**TZ-50**  

---

**126-810-100**  
**TZ-51**  

---

**126-811-100**





Dank des rechtwinkligen Querschnitts des Gipseinbaukanals kann in Wand und Decke nicht nur eine lineare, sondern eine geradlinige, flächenbündige und moderne Beleuchtung integriert werden. Die technische, funktionale und gestalterische Ausführung ist dabei vielfältig.

Thanks to the rectangular cross-section of the gypsum installation channel, not just a linear lighting, but a modern, straight-lined and recessed lighting system can be integrated in walls and ceilings. It offers extensive scope for technical, functional and creative design.

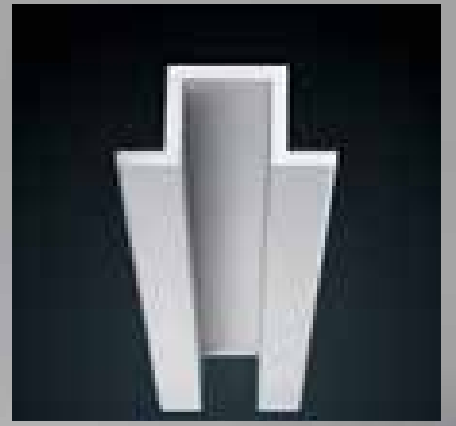

TZ-55 | TZ-56

# TZ-55 | TZ-56

## System

- › Einbaukanal aus Gipskarton für den randlosen Einbau in Gipskartondecken und -wände
- › Passgenaue LED / T16 Leuchteneinheiten in unterschiedlichen Längen
- › Wahlweise satinierte Abdeckung PUBLIC oder blendfreie Optik OFFICE
- › Werkzeuglose Montage der Leuchteneinheiten im Aluminiumprofil
- › Lichtverteilung direkt
- › Energieeffiziente Low-Power-LEDs



## System

- › Recessed gypsum mounting channel for seamless integration in plasterboard ceilings or walls
- › Matching LED / T16 lighting units in several different lengths
- › Choice between satinised cover PUBLIC and glare-free OFFICE optic
- › Tool-free assembly of the lighting units in the aluminium profile
- › Direct light distribution
- › Energy-efficient low power LEDs

## Einbaukanal aus Gips / Recessed mounting channel made of gypsum



### TZ-55

<b>40001.00</b>	1.000 mm	5,8 kg
<b>40002.00</b>	2.000 mm	11,8 kg
<b>40122.00</b>	Eckverbinder 90°, 2-teilig Corner connector 90°, 2-parts	11,8 kg

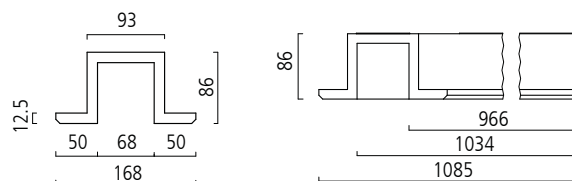

### TZ-56

<b>40003.00</b>	1.000 mm	6,0 kg
<b>40004.00</b>	2.000 mm	12,0 kg
<b>40123.00</b>	Eckverbinder. 2-teilig Corner connector 90°, 2-parts	12,0 kg

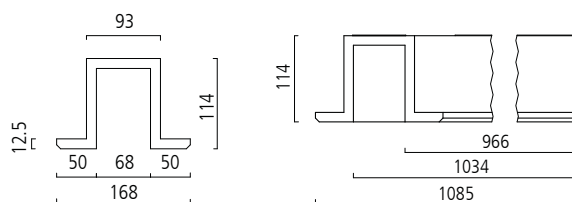

## Aluminiumprofil (L max. 3.000 mm) weiß / Aluminium profile (L max. 3.000 mm) white

### TZ-55

126-002-100-xxxx (mm)

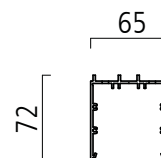
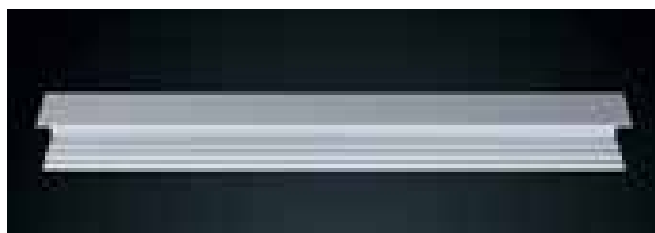

### TZ-56

126-003-100-xxxx (mm)

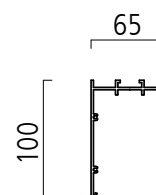
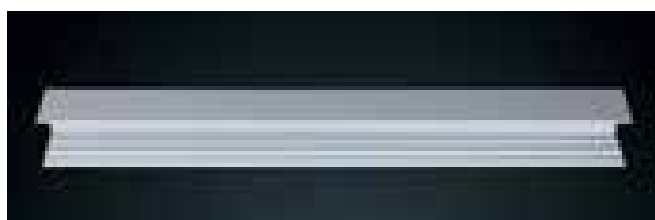

### Leuchteneinheiten, Bestellbeispiel und Schnellrechentabellen:

Lighting units, order example and easy planning guide:

Seite / page 272 - 275

Gipskanal, Aluminiumprofil, Zubehör + Leuchteneinheit bitte separat bestellen

Please order the gypsum channel, aluminium profile, accessories + lighting units separately

Bitte ergänzen Sie die Artikelnummer mit der gewünschten Profillänge: L = xxxx (mm).

Please complete the article number with the length of the profile: L = xxxx (mm).

## Zubehör / Accessories

Bitte ergänzen Sie die Artikelnummer mit der gewünschten Acryllänge/Abdeckungslänge: L = xxxx (mm)

Please complete the article number with the length of acrylic/blank element: L = xxxx (mm)



**PUBLIC**  
**Acrylabdeckung satiniert**  
 Acrylic cover satinised  
 L max. 3.000 mm  
**126-820-000-xxxx (mm) T16**  
**126-850-000-xxxx (mm) LED**



**OFFICE**  
**Prismatische Abdeckung**  
 Prismatic diffuser  
 L max. 3.000 mm  
**126-821-000-xxxx (mm) T16**  
**126-851-000-xxxx (mm) LED**

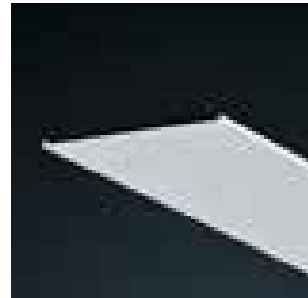

**Blindabdeckung**  
 Blank element  
 L max. 3.000 mm  
 weiß / white  
**126-822-100-xxxx (mm)**

Acrylabdeckungen werden grundsätzlich abzüglich Ausdehnungsfaktor geliefert  
 Acrylic covers are generally supplied less expansion factor



**Eckverbinder 90°**  
 Angle connector 90°  
 200 x 200 mm / weiß, white

**TZ-55**  
 PUBLIC  
 inkl. Acrylabdeckung satiniert  
 incl. acrylic cover satinised  
**126-802-100**  
 OFFICE  
 inkl. prismatischer Abdeckung  
 incl. prismatic diffuser  
**126-833-100**

**TZ-56**  
 PUBLIC  
 inkl. Acrylabdeckung satiniert  
 incl. acrylic cover satinised  
**126-803-100**  
 OFFICE  
 inkl. prismatischer Abdeckung  
 incl. prismatic diffuser  
**126-834-100**



**Linienverbinder**  
 Line connector

**TZ-55**  
**126-806-000**  
**TZ-56**  
**126-807-000**



**2 Enddeckel**  
 2 End caps  
 Tiefe, depth 2 mm / weiß, white

**TZ-55**  
**126-810-100**  
**TZ-56**  
**126-811-100**





Das Einbausystem TZ-57 mit abgewinkeltem Gipseinbaukanal ermöglicht einen besonderen architektonischen Effekt: Deckenbündig entlang der Wand oder wandbündig im Raumwinkel eingebaut, trennt die Beleuchtung die Bauteile. Das Licht verteilt sich homogen auf der Fläche und lässt eine Fuge entstehen. Bestückung und Länge sind variabel.

The TZ-57 installation system with an angled gypsum installation channel creates a special architectural effect. Recessed in the ceiling along the wall or recessed in the wall in the corner, this illumination separates the construction elements. The light is distributed evenly on the surface and creates a joint. Choice of luminants and lengths is available.





TZ-57

# TZ-57

## System

- › Einbaukanal aus Gipskarton für den randlosen Einbau in Gipskartondecken und -wände
- › Passgenaue LED / T16 Leuchteneinheiten in unterschiedlichen Längen
- › Wahlweise satinierte Abdeckung PUBLIC oder blendfreie Optik OFFICE
- › Werkzeuglose Montage der Leuchteneinheiten im Aluminiumprofil
- › Lichtverteilung direkt
- › Energieeffiziente Low-Power-LEDs



## System

- › Recessed gypsum mounting channel for seamless integration in plasterboard ceilings or walls
- › Matching LED / T16 lighting units in several different lengths
- › Choice between satinised cover PUBLIC and glare-free OFFICE optic
- › Tool-free assembly of the lighting units in the aluminium profile
- › Direct light distribution
- › Energy-efficient low power LEDs

## Einbaukanal aus Gips / Recessed mounting channel made of gypsum



TZ-57

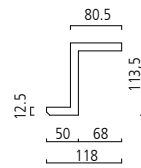

52001.00	1.000 mm	4,0 kg
52002.00	2.000 mm	8,0 kg

## Aluminiumprofil (L max. 3.000 mm) weiß Aluminium profile (L max. 3.000 mm) white

TZ-57

126-003-100-xxxx (mm)

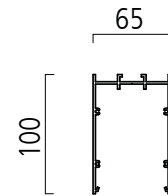
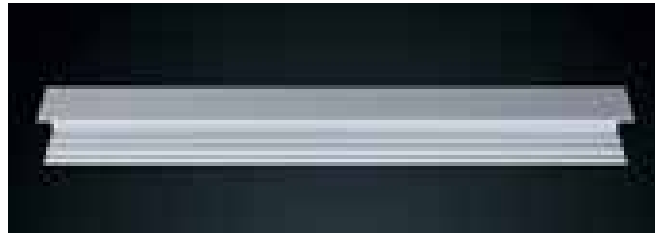

Bitte ergänzen Sie die Artikelnummer mit der gewünschten Acryllänge/Abdeckungsgröße: L = xxxx (mm)  
Please complete the article number with the length of acrylic/blank element: L = xxxx (mm)

## Zubehör / Accessories



**PUBLIC**  
**Acrylabdeckung satiniert**  
Acrylic cover satinised  
L max. 3.000 mm  
**126-820-000-xxxx (mm) T16**  
**126-850-000-xxxx (mm) LED**



**OFFICE**  
**Prismatische Abdeckung**  
Prismatic diffuser  
L max. 3.000 mm  
**126-821-000-xxxx (mm) T16**  
**126-851-000-xxxx (mm) LED**

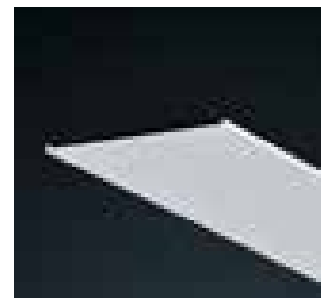

**Blindabdeckung**  
**Blank element**  
L max. 3.000 mm  
weiß / white  
**126-822-100-xxxx (mm)**

### Leuchteneinheiten, Bestellbeispiel und Schnellrechenabellen:

Lighting units, order example and easy planning guide:

Seite / page 272 - 275

Gipskanal, Aluminiumprofil, Zubehör + Leuchteneinheit bitte separat bestellen

Please order the gypsum channel, aluminium profile, accessories + lighting units separately

Acrylabdeckungen werden grundsätzlich abzüglich Ausdehnungsfaktor geliefert  
Acrylic covers are generally supplied less expansion factor



**Eckverbinder 90°**

Angle connector 90°

200 x 200 mm / weiß, white

PUBLIC

inkl. Acrylabdeckung satiniert

incl. acrylic cover satinised

**126-803-100**

OFFICE

inkl. prismatischer Abdeckung

incl. prismatic diffuser

**126-834-100**



**Linienverbinder**

Line connector

TZ-57

**126-807-000**



**2 Enddeckel**

2 End caps

Tiefe, depth 2 mm / weiß, white

TZ-57

**126-811-100**





Der hervorstehende Gipseinbaukanal mit abgerundeten Konturen setzt die lineare Beleuchtung besonders in Szene. Randlos in die Gipskartonkonstruktion von Decke oder Wand eingebaut, entsteht eine Ausstülpung, die die Leuchte aufnimmt. Bestückung, Abdeckung und Länge sind variabel.

The protruding gypsum installation channel with rounded contours specially emphasizes the linear lighting. Seamlessly integrated in the plasterboard structure of a wall or ceiling, a protrusion is created to contain the light. Luminants, covers and lengths are variable.



TZ-60

# TZ-60

## System

- › Einbaukanal aus Gipskarton für den randlosen Einbau in Gipskartondecken und -wände
- › Passgenaue LED / T16 Leuchteneinheiten in unterschiedlichen Längen
- › Wahlweise satinierte Abdeckung PUBLIC oder blendfreie Optik OFFICE
- › Werkzeuglose Montage der Leuchteneinheiten im Aluminiumprofil
- › Lichtverteilung direkt
- › Energieeffiziente Low-Power-LEDs



## System

- › Recessed gypsum mounting channel for seamless integration in plasterboard ceilings or walls
- › Matching LED / T16 lighting units in several different lengths
- › Choice between satinised cover PUBLIC and glare-free OFFICE optic
- › Tool-free assembly of the lighting units in the aluminium profile
- › Direct light distribution
- › Energy-efficient low power LEDs

## Einbaukanal aus Gips / Recessed mounting channel made of gypsum



### TZ-60

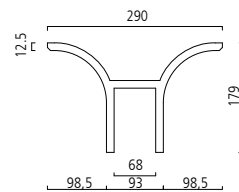

<b>50002.00</b>	2.000 mm, Einbaukanal aus Gips / gypsum installation channel	19,7 kg
<b>50129.00</b>	Endstück aus Gipskarton / End cap made of plasterboard	0,2 kg
<b>50130.00</b>	Endstück aus Gips / End cap made of gypsum	1,0 kg

## Aluminiumprofil (L max. 3.000 mm) weiß / Aluminium profile (L max. 3.000 mm) white

### TZ-60

126-003-100-xxxx (mm)

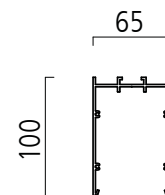
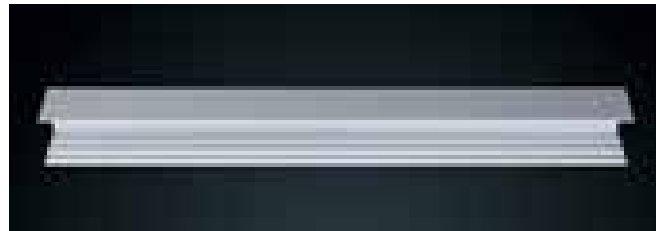

Bitte ergänzen Sie die Artikelnummer mit der gewünschten Profillänge: L = xxxx (mm).  
Please complete the article number with the length of the profile: L = xxxx (mm).

## Zubehör / Accessories

### Leuchteneinheiten, Bestellbeispiel und Schnellrechentabellen:

Lighting units, order example and easy planning guide:

Seite / page 272 - 275

Gipskanal, Aluminiumprofil, Zubehör + Leuchteneinheit bitte separat bestellen

Please order the gypsum channel, aluminium profile, accessories + lighting units separately



**PUBLIC**  
Acrylabdeckung satiniert

Acrylic cover satinised  
L max. 3.000 mm  
**126-820-000-xxxx (mm) T16**  
**126-850-000-xxxx (mm) LED**



**OFFICE**  
Prismatische Abdeckung

Prismatic diffuser  
L max. 3.000 mm  
**126-821-000-xxxx (mm) T16**  
**126-851-000-xxxx (mm) LED**



**Blindabdeckung**

Blank element  
L max. 3.000 mm  
weiß / white  
**126-822-100-xxxx (mm)**

Acrylabdeckungen werden grundsätzlich abzüglich Ausdehnungsfaktor geliefert  
Acrylic covers are generally supplied less expansion factor



**Eckverbinder 90°**

Angle connector 90°

200 x 200 mm / weiß, white

PUBLIC

inkl. Acrylabdeckung satiniert

incl. acrylic cover satinised

**126-803-100**

OFFICE

inkl. prismatischer Abdeckung

incl. prismatic diffuser

**126-834-100**



**Linienverbinder**

Line connector

TZ-60

**126-807-000**



**2 Enddeckel**

2 End caps

Tiefe, depth 2 mm / weiß, white

TZ-60

**126-811-100**





Mit dem Einbausystem TZ-100 | TZ-101 können interessante Effekte durch die blendfreie, indirekte Beleuchtung von Wänden, Decken und Böden erzielt werden. Die Form des randlos in Wand oder Decke eingebauten Gipseinbaukanals lässt das Licht indirekt auf die benachbarte Fläche strahlen. Bestückung und Länge sind variabel.

With the TZ-100 | TZ-101 installation system, interesting effects can be achieved with glare-free indirect illumination of walls, ceilings and floors. The form of the gypsum installation channel seamlessly recessed in a wall or ceiling causes the light to shine indirectly onto the adjacent surface. Choice of luminants and length is available.





TZ-100 | TZ-101

# TZ-100 | TZ-101

## System

- › Einbaukanal aus Gipskarton für den randlosen Einbau in Gipskartondecken und -wände
- › Passgenaue LED / T16 Leuchteneinheiten in unterschiedlichen Längen
- › Wahlweise satinierte Abdeckung PUBLIC oder blendfreie Optik OFFICE
- › Werkzeuglose Montage der Leuchteneinheiten im Aluminiumprofil
- › Lichtverteilung direkt
- › Energieeffiziente Low-Power-LEDs



## System

- › Recessed gypsum mounting channel for seamless integration in plasterboard ceilings or walls
- › Matching LED / T16 lighting units in several different lengths
- › Choice between satinised cover PUBLIC and glare-free OFFICE optic
- › Tool-free assembly of the lighting units in the aluminium profile
- › Direct light distribution
- › Energy-efficient low power LEDs

## Einbaukanal aus Gips / Recessed mounting channel made of gypsum



TZ-100

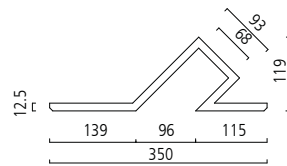

<b>41001.00</b>	1.000 mm	6,4 kg
<b>41002.00</b>	2.000 mm	13,0 kg

TZ-101

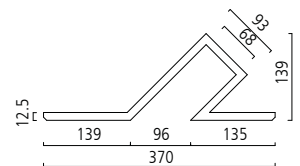

<b>41004.00</b>	1.000 mm	6,6 kg
<b>41005.00</b>	2.000 mm	13,2 kg

## Aluminiumprofil (L max. 3.000 mm) weiß / Aluminium profile (L max. 3.000 mm) white

TZ-100

126-002-100-xxxx (mm)

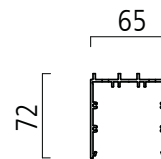

TZ-101

126-003-100-xxxx (mm)

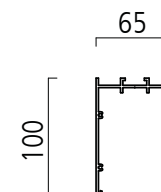

### Leuchteneinheiten, Bestellbeispiel und Schnellrechen tabellen:

Lighting units, order example and easy planning guide:

Seite / page 272 - 275

Bitte ergänzen Sie die Artikelnummer mit der gewünschten Profillänge: L = xxxx (mm).

Please complete the article number with the length of the profile: L = xxxx (mm).

Gipskanal, Aluminiumprofil, Zubehör + Leuchteneinheit bitte separat bestellen

Please order the gypsum channel, aluminium profile, accessories + lighting units separately

## Zubehör / Accessories

Bitte ergänzen Sie die Artikelnummer mit der gewünschten Acryllänge/Abdeckungslänge: L = xxxx (mm)

Please complete the article number with the length of acrylic/blank element: L = xxxx (mm)



**PUBLIC**  
**Acrylabdeckung satiniert**  
 Acrylic cover satinised  
 L max. 3.000 mm  
**126-820-000-xxxx (mm) T16**  
**126-850-000-xxxx (mm) LED**



**OFFICE**  
**Prismatische Abdeckung**  
 Prismatic diffuser  
 L max. 3.000 mm  
**126-821-000-xxxx (mm) T16**  
**126-851-000-xxxx (mm) LED**

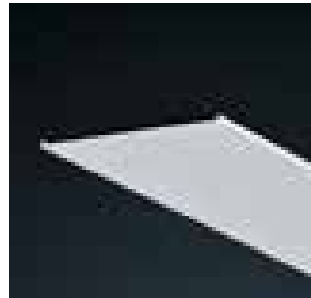

**Blindabdeckung**  
 Blank element  
 L max. 3.000 mm  
 weiß / white  
**126-822-100-xxxx (mm)**

Acrylabdeckungen werden grundsätzlich abzüglich Ausdehnungsfaktor geliefert  
 Acrylic covers are generally supplied less expansion factor



**Eckverbinder 90°**  
 Angle connector 90°  
 200 x 200 mm / weiß, white  
**TZ-100**

**PUBLIC**  
 inkl. Acrylabdeckung satiniert  
 incl. acrylic cover satinised  
**126-802-100**  
**OFFICE**  
 inkl. prismatischer Abdeckung  
 incl. prismatic diffuser  
**126-833-100**

**TZ-101**

**PUBLIC**  
 inkl. Acrylabdeckung satiniert  
 incl. acrylic cover satinised  
**126-803-100**  
**OFFICE**  
 inkl. prismatischer Abdeckung  
 incl. prismatic diffuser  
**126-834-100**



**Linienvorbinder**  
 Line connector

**TZ-100**

**126-806-000**  
**TZ-101**  
**126-807-000**



**2 Enddeckel**  
 2 End caps  
 Tiefe, depth 2 mm / weiß, white

**TZ-100**

**126-810-000**  
**TZ-101**  
**126-811-100**



# TZ-50 → TZ-101

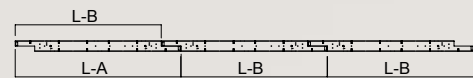
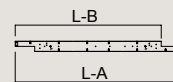
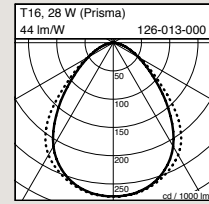
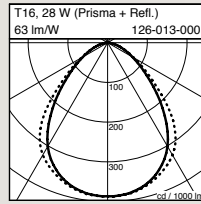
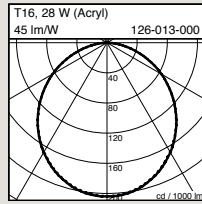
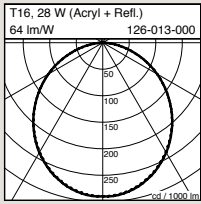

## Leuchteneinheit T16 mit 5 poliger Durchgangsverdrahtung, diagonal überlappend

Lighting unit T16 with 5 pole electrical connection, diagonally overlapping

L-A	L-B	T16	ON/OFF	DIM 1-10V	DIM DALI	kg	Reflektor
580 mm	495 mm	1 x T16, 14/24 W, EVG	<b>126-011-000</b>	<b>126-011-010</b>	<b>126-011-020</b>	0,8	<b>126-823-000</b>
880 mm	770 mm	1 x T16, 21/39 W, EVG	<b>126-012-000</b>	<b>126-012-010</b>	<b>126-012-020</b>	1,0	<b>126-824-000</b>
1.180 mm	1.070 mm	1 x T16, 28/54 W, EVG	<b>126-013-000</b>	<b>126-013-010</b>	<b>126-013-020</b>	1,3	<b>126-825-000</b>
1.480 mm	1.370 mm	1 x T16, 35/49 W, EVG	<b>126-014-000</b>	<b>126-014-010</b>	<b>126-014-020</b>	1,5	<b>126-826-000</b>

## Leuchteneinheit T16 für Einzelleuchten, gerade

Lighting unit T16 for single luminaires, straight

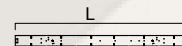

L	T16	ON/OFF	DIM 1-10V	DIM DALI	KG	Reflektor
880 mm	1 x T16, 21/39 W, EVG	<b>126-040-000</b>	<b>126-040-010</b>	<b>126-040-020</b>	1,0	<b>126-829-000</b>
1.180 mm	1 x T16, 28/54 W, EVG	<b>126-041-000</b>	<b>126-041-010</b>	<b>126-041-020</b>	1,3	<b>126-830-000</b>
1.480 mm	1 x T16, 35/49 W, EVG	<b>126-042-000</b>	<b>126-042-010</b>	<b>126-042-020</b>	1,5	<b>126-831-000</b>

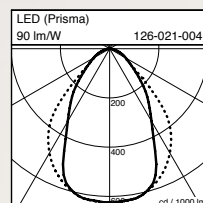
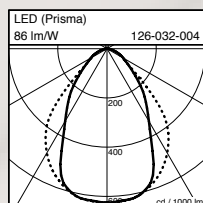
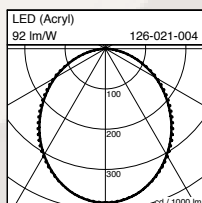
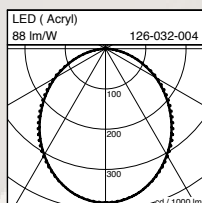

**Leuchteinheit LED mit 5 poliger Durchgangsverdrahtung (LED Leistung ca. 2400 lm/m) Ra > 80**

Lighting unit LED with 5 pole electrical connection (LED power appr. 2400 lm/m) Ra > 80

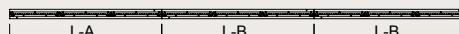

		3000K					4000K				
L-A	L-B	W	PUBLIC	OFFICE	ON /OFF	DIM DALI	PUBLIC	OFFICE	ON /OFF	DIM DALI	kg
850 mm	841 mm	16 W	80 lm/W	78 lm/W	<b>126-031-003</b>	<b>126-031-023</b>	82 lm/W	80 lm/W	<b>126-031-004</b>	<b>126-031-024</b>	0,6
990 mm	981 mm	18 W	83 lm/W	81 lm/W	<b>126-035-003</b>	<b>126-035-023</b>	85 lm/W	83 lm/W	<b>126-035-004</b>	<b>126-035-024</b>	0,7
1.130 mm	1.121 mm	20 W	85 lm/W	83 lm/W	<b>126-032-003</b>	<b>126-032-023</b>	88 lm/W	86 lm/W	<b>126-032-004</b>	<b>126-032-024</b>	0,8
1.410 mm	1.401 mm	25 W	85 lm/W	83 lm/W	<b>126-033-003</b>	<b>126-033-023</b>	88 lm/W	86 lm/W	<b>126-033-004</b>	<b>126-033-024</b>	1,0
1.690 mm	1.681 mm	29 W	88 lm/W	86 lm/W	<b>126-034-003</b>	<b>126-034-023</b>	91 lm/W	89 lm/W	<b>126-034-004</b>	<b>126-034-024</b>	1,2



**Leuchteinheit LED mit 5 poliger Durchgangsverdrahtung (LED Leistung ca. 4300 lm/m) Ra > 80**

Lighting unit LED with 5 pole electrical connection (LED power appr. 4300 lm/m) Ra > 80

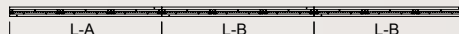

		3000K					4000K				Tunable white 3000-6000K	
L-A	L-B	W	PUBLIC	OFFICE	ON /OFF	DIM DALI	PUBLIC	OFFICE	ON /OFF	DIM DALI	DIM DALI	kg
850 mm	841 mm	27 W	87 lm/W	85 lm/W	<b>126-020-003</b>	<b>126-020-023</b>	89 lm/W	88 lm/W	<b>126-020-004</b>	<b>126-020-024</b>	<b>126-020-029*</b>	0,6
990 mm	981 mm	31 W	88 lm/W	86 lm/W	<b>126-024-003</b>	<b>126-024-023</b>	91 lm/W	89 lm/W	<b>126-024-004</b>	<b>126-024-024</b>		0,7
1.130 mm	1.121 mm	35 W	89 lm/W	87 lm/W	<b>126-021-003</b>	<b>126-021-023</b>	92 lm/W	90 lm/W	<b>126-021-004</b>	<b>126-021-024</b>	<b>126-021-029*</b>	0,8
1.410 mm	1.401 mm	43 W	91 lm/W	89 lm/W	<b>126-022-003</b>	<b>126-022-023</b>	94 lm/W	92 lm/W	<b>126-022-004</b>	<b>126-022-024</b>	<b>126-022-029*</b>	1,0
1.690 mm	1.681 mm	51 W	92 lm/W	90 lm/W	<b>126-023-003</b>	<b>126-023-023</b>	95 lm/W	93 lm/W	<b>126-023-004</b>	<b>126-023-024</b>		1,2

**PUBLIC** Acrylabdeckung satiniert / Acrylic cover satinised

**OFFICE** Prismatische Abdeckung / Prismatic diffuser

\* DALI DT8 (Device Type 8) erforderlich / required

# TZ-50 → TZ-101

## Schnellrechentabelle Easy planning guide

### Leuchteneinheiten T16 diagonal überlappend

Lighting units T16 diagonally overlapping

Systemlänge* System length*	Leuchteneinheit Lighting unit							
	14/24 W		21/39 W		28/54 W		35/49 W	
	Anzahl Quantity	Länge Length	Anzahl Quantity	Länge Length	Anzahl Quantity	Länge Length	Anzahl Quantity	Länge Length
1.000 mm	1	580 mm	1	880 mm				
1.500 mm	2	1.075 mm			1	1.180 mm	1	1.480 mm
2.000 mm	3	1.570 mm	2	1.650 mm				
2.500 mm	4	2.065 mm	3	2.420 mm	2	2.250 mm		
3.000 mm	5	2.560 mm					2	2.850 mm
3.500 mm	6	3.055 mm	4	3.190 mm	3	3.320 mm		
4.000 mm	7	3.550 mm	5	3.960 mm				
4.500 mm	8	4.045 mm			4	4.390 mm	3	4.220 mm
5.000 mm	9	4.540 mm	6	4.730 mm				
5.500 mm	10	5.035 mm	7	5.500 mm	5	5.460 mm		
6.000 mm	11	5.530 mm	7	5.500 mm			4	5.590 mm
6.500 mm	12	6.025 mm	8	6.270 mm	6	6.530 mm		
7.000 mm	13	6.520 mm					5	6.960 mm
7.500 mm	14	7.015 mm	9	7.040 mm				
8.000 mm	15	7.510 mm	10	7.810 mm	7	7.600 mm		
8.500 mm	17	8.500 mm					6	8.330 mm
9.000 mm	18	8.995 mm	11	8.580 mm	8	8.670 mm		
9.500 mm	19	9.490 mm	12	9.350 mm				
10.000 mm	20	9.985 mm			9	9.740 mm	7	9.700 mm
10.500 mm	21	10.480 mm	13	10.120 mm				
11.000 mm	22	10.975 mm	14	10.890 mm	10	10.810 mm		
11.500 mm	23	11.470 mm	15	11.660 mm			8	11.070 mm
12.000 mm	24	11.965 mm			11	11.880 mm		
12.500 mm	25	12.460 mm	16	12.430 mm			9	12.440 mm
13.000 mm	26	12.955 mm			12	12.950 mm		
13.500 mm	27	13.450 mm	17	13.200 mm				
14.000 mm	28	13.945 mm	18	13.970 mm			10	13.810 mm
14.500 mm	29	14.440 mm			13	14.020 mm		
15.000 mm	30	14.935 mm	19	14.740 mm				
15.500 mm	31	15.430 mm			14	15.090 mm	11	15.180 mm
16.000 mm	32	15.925 mm	20	15.510 mm				
16.500 mm	33	16.420 mm	21	16.280 mm	15	16.160 mm		
17.000 mm	34	16.915 mm					12	16.550 mm
17.500 mm	35	17.410 mm	22	17.050 mm	16	17.230 mm		
18.000 mm	36	17.905 mm	23	17.820 mm			13	17.920 mm
18.500 mm	37	18.400 mm			17	18.300 mm		
19.000 mm	38	18.895 mm	24	18.590 mm				
19.500 mm	39	19.390 mm	25	19.360 mm	18	19.370 mm	14	19.290 mm
20.000 mm	40	19.885 mm						

## Leuchteneinheiten LED

Lighting units LED

### 3.000 K / 4.000 K

Systemlänge* System length*	Anzahl der LED-Leuchteneinheiten Number of LED lighting units				
	841 mm	981 mm	1.121 mm	1.401 mm	1.681 mm
850 mm	1				
990 mm		1			
1.130 mm			1		
1.410 mm				1	
1.690 mm					1
1.831 mm	1	1			
1.971 mm	1		1		
2.111 mm		1	1		
2.251 mm			2		
2.391 mm		1		1	
2.531 mm			1	1	
2.671 mm		1			1
2.811 mm			1		1
2.952 mm	1	1	1		
3.091 mm				1	1
3.232 mm		1	2		
3.371 mm					2
3.512 mm		1	1	1	
3.652 mm			2	1	
3.792 mm		1		2	
3.932 mm			2		1
4.072 mm		1		1	1
4.212 mm				3	
4.352 mm		1			2
4.492 mm				2	1
4.633 mm	1	1	1		1
4.772 mm				1	2
4.913 mm		1	2		1
5.052 mm					3
5.473 mm		1		2	1
5.333 mm			1	3	
5.613 mm			2		2

Systemlänge* System length*	Anzahl der LED-Leuchteneinheiten Number of LED lighting units				
	841 mm	981 mm	1.121 mm	1.401 mm	1.681 mm
5.753 mm		1		1	2
5.893 mm				3	1
6.033 mm		1			3
6.173 mm				2	2
6.314 mm		1	2	1	1
6.453 mm				1	3
6.594 mm	1	1		1	2
6.733 mm					4
6.874 mm	1	1			3
7.014 mm				5	
7.154 mm		1	1		3
7.294 mm				4	1
7.434 mm		1		1	3
7.574 mm				3	2
7.714 mm		1			4
7.854 mm				2	3
7.995 mm	1	1	1		3
8.134 mm				1	4
8.275 mm		1	2		3
8.414 mm					5
8.555 mm		1	1	1	3
8.695 mm				5	1
8.835 mm		1	1		4
8.975 mm				4	2
9.115 mm		1		1	4
9.255 mm				3	3
9.395 mm		1			5
9.535 mm				2	4
9.676 mm	1	1	1		4
9.815 mm				1	5
9.956 mm		1	2		4
10.095 mm					6

### Tunable White

Systemlänge* System length*	Anzahl der LED-Leuchteneinheiten Number of LED lighting units		
	844 mm	1.121 mm	1.401 mm
850 mm	1		
1.130 mm		1	
1.410 mm			1
1.691 mm	2		
1.971 mm	1	1	
2.251 mm	1		1
2.531 mm		1	1
2.811 mm			2
3.092 mm	1	2	
3.372 mm		3	
3.652 mm		2	1
3.932 mm		1	2
4.212 mm			3
4.493 mm	1	2	1
4.773 mm		3	1
5.053 mm		2	2
5.333 mm		1	3
5.613 mm			4
5.894 mm	1	2	2
6.174 mm		3	2
6.454 mm		2	3
6.734 mm		1	4
7.014 mm			5
7.295 mm	1	2	3
7.575 mm		3	3
7.855 mm		2	4
8.135 mm		1	5
8.415 mm			6
8.696 mm		4	3
8.976 mm		3	4
9.256 mm		2	5
9.536 mm		1	6
9.816 mm			7

\* Alle Systemlängen ohne Enddeckel. / All system lengths excluding end caps.



Besonders in großen Räumen ermöglicht das Voutensystem eine kreative Deckengestaltung. Die Voutenelemente aus Gips mit abgerundeten Konturen werden randlos in Gipskartondecken eingebaut und bilden eine homogene und schattenfrei ausgeleuchtete Lichtvoute ohne sichtbare Ecken oder Kanten. Aus Geraden und Viertelbögen mit unterschiedlichen Radien lassen sich Kreise, Ovale oder andere freie Formen gestalten. Bei einer Bestückung mit RGB-LED sind auf Wunsch farbige Lichteffekte möglich.

The cove lighting system enables creative design of ceilings especially in large rooms. The gypsum cove elements with rounded contours are seamlessly integrated in plasterboard ceilings and form a homogeneously illuminated light cove without shadows or visible sharp edges or corners. Straight lines and quarter circles with varying radii, full circles, ovals or other free forms can be created. With LED luminaires, coloured light effects are possible if desired.





TZ-200

# TZ-200

## System

- › Gipsvoutenelemente für den randlosen Einbau in Gipskartondecken
- › Gleichbleibend hohe Qualität durch vorgefertigte Gips-Module
- › Schattenfreie Ausleuchtung, auch in den Radien
- › Passgenaue LED Stripes / T16 Leuchteneinheiten in unterschiedlichen Längen
- › T16 Einlegeleuchten mit steckerfertigen Anschluss- und Verbindungsleitungen
- › LED-Stripe weiß oder RGB wahlweise mit Funkfernbedienung
- › Lichtverteilung indirekt



## System

- › Cove element, made of gypsum for seamless installation in plasterboard ceilings
- › Consistent high quality by use of prefabricated gypsum modules
- › Shadow-free illumination, also in the curves
- › Matching LED stripes / T16 lighting units in several different lengths
- › T16 lighting units with plug and play connection cables
- › LED stripe white or RGB with optional radio remote control
- › Indirect light distribution

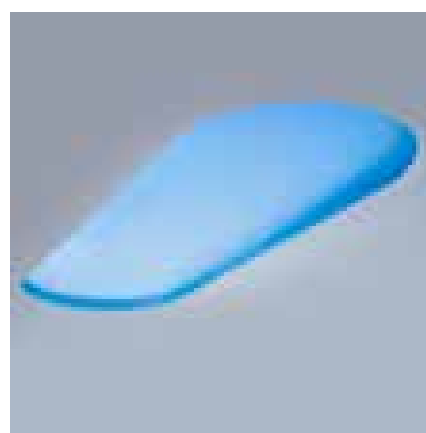



# TZ-200

## System

- › Bestehend aus Ober- und Unterteil mit Führung für LED-Stripes und für T16 Einlegeleuchten



## System

- › Consisting of upper and lower part, including track for LED stripes and T16 luminaires

## Voutenelemente aus Gips / Cove elements made of gypsum

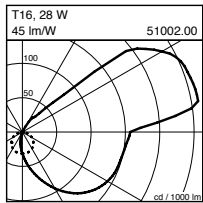

### Gerade / Straight

	L	L-LED Stripe	L-T16	kg
51002.00	2.000 mm	2.000 mm	2.000 mm	24

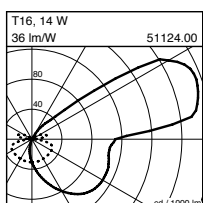
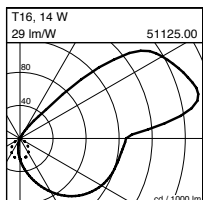
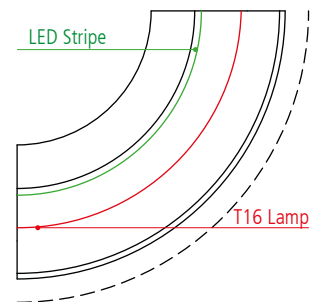
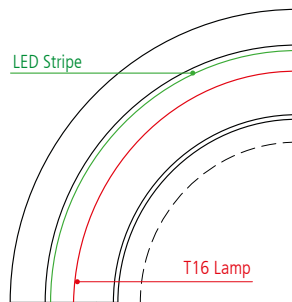
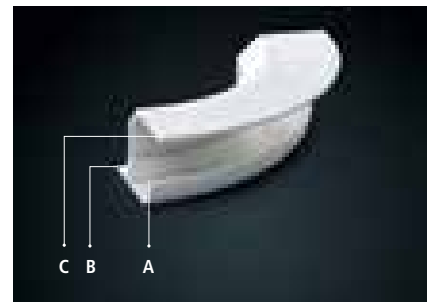
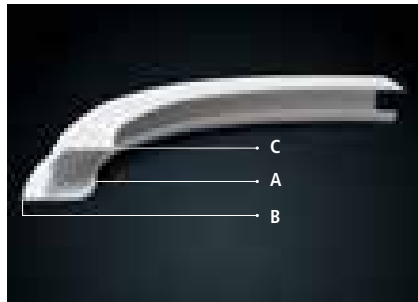
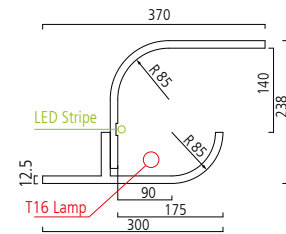

### Viertelbogen, Innenradius

Quarter bend, inside radius

	A	B	C	L-LED Stripe	L-T16	kg
51125.00	500 mm	800 mm	430 mm	1.068 mm	990 mm (14/24 W)	12
51122.00	800 mm	1.100 mm	730 mm	1.539 mm	1.461 mm (14/24 W)	18
51123.00	1.200 mm	1.500 mm	1.130 mm	2.168 mm	2.089 mm (14/24 W) (21/39 W)	27

### Viertelbogen, Außenradius

Quarter bend, outside radius

	A	B	C	L-LED Stripe	L-T16	kg
51124.00	600 mm	300 mm	670 mm	660 mm	738 mm	11

SB-Service



BW | Bank



# TZ-200

## System

- › T16 Einlegeleuchte glanzweiß
- › Steckerfertige Anschluss- und Verbindungsleitungen bitte separat bestellen
- › T16 Einlegeleuchten und LED Einheiten dürfen aus thermischen Gründen nicht gleichzeitig betrieben werden

## System

- › T16 Recessed light glossy-white
- › Please order Plug and play connection cables separately
- › T16 recessed lights and LED units must not be operated simultaneously for thermal reasons

## Leuchteneinheiten / Lighting units



Länge Length	Lamp	kg	ON/OFF	DIM 1-10V	DIM DALI
580 mm	T16 / T16 Seamless, 14/24 W, G5	1,0	<b>51501.14</b>	<b>51501.141</b>	<b>51501.142</b>
880 mm	T16 / T16 Seamless, 21/39 W, G5	1,4	<b>51502.14</b>	<b>51502.141</b>	<b>51502.142</b>
1.880 mm	T16 / T16 Seamless, 28/54 W, G5	1,7	<b>51503.14</b>	<b>51503.141</b>	<b>51503.142</b>

## Zubehör / Accessories



**Anschlussleitung 3-polig** (3 x 1,5 mm<sup>2</sup>)  
 3-Pole power supply cable (3 x 1,5 mm<sup>2</sup>)  
**92247** L 250 mm

**Anschlussleitung 5-polig** (3 x 1,5 mm<sup>2</sup> + 2 x 0,75 mm<sup>2</sup>)  
 5-Pole power supply cable (3 x 1,5 mm<sup>2</sup> + 2 x 0,75 mm<sup>2</sup>)  
**92251** L 250 mm

**Verbindungsleitung 3-polig** (3 x 1,5 mm<sup>2</sup>)  
 3-Pole connection line (3 x 1,5 mm<sup>2</sup>)  
**92248** L 500 mm  
**92249** L 1.000 mm  
**92250** L 2.000 mm

**Verbindungsleitung 5-polig** (3 x 1,5 mm<sup>2</sup> + 2 x 0,75 mm<sup>2</sup>)  
 5-Pole connection line (3 x 1,5 mm<sup>2</sup> + 2 x 0,75 mm<sup>2</sup>)  
**92252** L 500 mm  
**92253** L 1.000 mm  
**92254** L 2.000 mm

## Zubehör / Accessories



**Netzteil, 24 V DC**  
Power supply, 24 V DC  
**92242** 60 W  
**92267** 120 W  
**92268** 240 W



**Funkfernbedienung**  
Radio remote control  
**92245**



**Funksteuergerät**  
Radio control unit  
**92246**



**Dimm-Modul**  
Dim Module

LED weiß / white  
1-10 V, 24 V DC,  
max. 120 W, exklusiv Netzteil  
1-10 V, 24 V DC,  
max. 120 W, without power supply  
**92327**

---

LED weiß / white  
DALI 24 V DC,  
max. 120 W, exklusiv Netzteil  
DALI 24 V DC,  
max. 120 W, without power supply  
**92328**

---

LED RGB  
DALI 24 V DC, inklusiv Netzteil 75 W  
DALI 24 V DC, including power supply 75 W  
**92329**

---

LED RGB  
DMX 24 V DC,  
max. 140 W, exklusiv Netzteil  
DMX 24 V DC,  
max. 140 W, without power supply  
**92330**

---

# TZ-200

## System

- › LED-Stripe weiß oder LED-Stripe RGB
- › LED-Stripe kürzbar alle 100 mm



## System

- › LED stripe white or LED stripe RGB
- › LED stripe can be shortened every 100 mm

## LED Einheiten / LED units



### LED-Stripe weiß / white

96 W (19 W/m), 3000 K

**92331** L 5.000 mm

96 W (19 W/m), 4000 K

**92255** L 5.000 mm

### LED-Stripe RGB / coloured

72 W (18 W/m)

**92266** L 4.000 mm

## Die Anordnung von LED Einheiten in der Lichtvoute

LED Stripes werden mit der rückwandigen Klebefolie des Stripes in die dafür vorgesehene Führung des Lichtvouten-Oberteils geklebt. Entsprechende Netzteile und Steuergeräte werden in das Unterteil der Lichtvoute gelegt.

LED Einheiten und T16/T16 Seamless Einlegeleuchten dürfen aus thermischen Gründen nicht gleichzeitig betrieben werden (nur getrennt schaltbar). LED Stripes werden nur direkt am Netzteil angeschlossen und dürfen nicht verlängert bzw. hintereinander geschaltet werden.

## The arrangement of LED units in cove light

Using the adhesive film of the stripes, the LED stripes are glued into the prepared track in the cove element. Corresponding power supply units and control units are placed in the lower part of the cove element.

LED units and T16/T16 seamless recessed lights must not be operated simultaneously to avoid thermal overload (switchable separately only). LED stripes are connected to the power supply unit directly only and may not be extended and/or connected one after another.

Das erforderliche Zubehör für LED-Stripe weiß (Netzteil, Dimm-Modul) oder für LED-Stripe RGB (Netzteil, Dimm-Modul, Funkfernbedienung, Funksteuergerät) bitte separat bestellen, Seite 283.

Please order the necessary accessories for LED stripe white (power supply, dim module) or for the LED stripe RGB (power supply unit, dim module, radio remote control, radio control unit) separately, page 283.



### System

- › Vollkreis bestehend aus Gipsmodul-Viertelbögen, bestückt mit T16 Einlegeleuchten oder LED-Einheiten.

### System

- › Full circle consisting of gypsum module quarter bends, equipped with T16 recessed lights or LED units.

T16 Einlegeleuchten oder LED Einheiten bitte separat bestellen.  
Please order T16 recessed lights or LED units separately.

### Vollkreis Ø 1.000 mm / Full circle Ø 1.000 mm

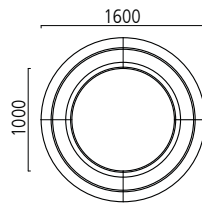

<b>51126.00</b>	4 x Gipsmodul-Viertelbogen, Innenradius 500 mm 4 x Gypsum module quarter bend, inside radius 500 mm
<b>51131.14</b>	6 x T16/T16 Seamless, 14/24 W, G5, ON/OFF
<b>51131.141</b>	6 x T16/T16 Seamless, 14/24 W, G5, DIM 1 -10 V
<b>51131.142</b>	6 x T16/T16 Seamless, 14/24 W, G5, DIM DALI
<b>51132.00</b>	1 x LED Stripe weiß / white 5 m, 4000 K Netzteil / power supply
<b>51140.00</b>	1 x LED Stripe weiß / white 5 m, 3000 K Netzteil / power supply
<b>51133.00</b>	1 x LED-Stripe RGB 4 m Netzteil / power Funkfernbedienung / radio remote control Funksteuergerät / radio control unit

### Vollkreis Ø 1.600 mm / Full circle Ø 1.600 mm

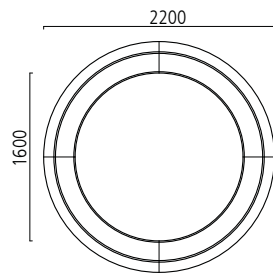

<b>51127.00</b>	4 x Gipsmodul-Viertelbogen, Innenradius 800 mm 4 x Gypsum module quarter bend, inside radius 800 mm
<b>51134.14</b>	9 x T16/T16 Seamless, 14/24 W, G5, ON/OFF
<b>51134.141</b>	9 x T16/T16 Seamless, 14/24 W, G5, DIM 1 -10 V
<b>51134.142</b>	9 x T16/T16 Seamless, 14/24 W, G5, DIM DALI
<b>51135.00</b>	2 x LED Stripe weiß / white 5 m, 4000 K Netzteil / power supply
<b>51141.00</b>	2 x LED Stripe weiß / white 5 m, 3000 K Netzteil / power supply
<b>51136.00</b>	2 x LED-Stripe RGB 4 m Netzteil / power Funkfernbedienung / radio remote control Funksteuergerät / radio control unit

### Vollkreis Ø 2.400 mm / Full circle Ø 2.400 mm

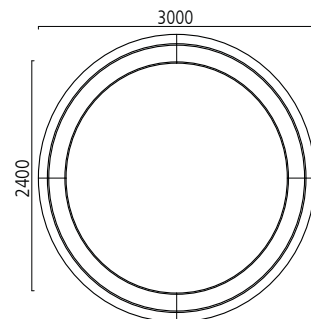

<b>51128.00</b>	4 x Gipsmodul-Viertelbogen, Innenradius 1.200 mm 4 x Gypsum module quarter bend, inside radius 1,200 mm
<b>51137.14</b>	9 x T16/T16 Seamless, 21/39 W, G5, ON/OFF
<b>51137.141</b>	9 x T16/T16 Seamless, 21/39 W, G5, DIM 1 -10 V
<b>51137.142</b>	9 x T16/T16 Seamless, 21/39 W, G5, DIM DALI
<b>51138.00</b>	2 x LED Stripe weiß / white 5 m, 4000 K Netzteil / power supply
<b>51142.00</b>	2 x LED Stripe weiß / white 5 m, 3000 K Netzteil / power supply
<b>51139.00</b>	3 x LED-Stripe RGB 4 m Netzteil / power Funkfernbedienung / radio remote control Funksteuergerät / radio control unit

# TZ-200

## Die Anordnung von Leuchten in der Lichtvoute

T16 / T16 Seamless Einlegeleuchten werden in den unteren Teil der Lichtvoute gelegt. Leuchten werden mittels 3- oder 5-poliger Anschluss- bzw. Verbindungsleitung (mit Stecker und und Buchse) elektrifiziert und miteinander verbunden.

## The arrangement of lights in the cove units

T16 / T16 seamless recessed lights are placed into the lower part of the gypsum element. Lights are electrified and connected with 3-pole or 5-pole connecting lines (with plug and socket).

T16 Einlegeleuchte in der Geraden  
T16 recessed light in a straight



T16 Einlegeleuchte im Radius  
T16 recessed lights in the radius



Einspeisung der T16 Einlegeleuchte  
Power feed of the T16 luminaires



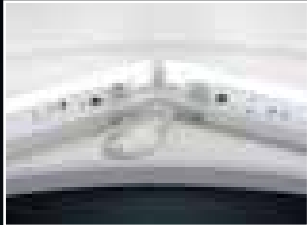

T16 Seamless Einlegeleuchte im Radius  
T16 seamless recessed lights in the radius

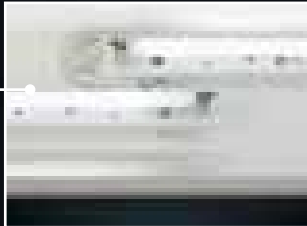

T16 Einlegeleuchte im Versatz  
Recessed lights T16 in offset arrangement

# MONTAGE / ASSEMBLY

## Einfach, schnell und sauber am Beispiel TZ-51

Leichteres Arbeiten für alle Gewerke: Einfach, schnell und sauber setzen Trockenbauer die vorgefertigten Gipselemente in die Deckenunterkonstruktion oder das Wandständerwerk ein. Die Gefahr von Fugen- oder Kantenrissen besteht praktisch nicht mehr. Nachdem die Fugen verspachtelt und die Wände bzw. Decken gestrichen sind, lassen sich die passgenauen Leuchten sehr einfach montieren und elektrifizieren.

## Simple, fast and clean using TZ-51 as an example

Easy work for all trades: Contractors simply install the prefabricated gypsum units in the ceiling substructure or wall posts. The risk of cracks appearing in joints or edges is virtually eliminated. After the joints have been plastered and the walls and/or ceilings have been painted, the light fixtures can be easily installed.



In diese Standard-Unterkonstruktionen wird das vorgefertigte Gipselement eingesetzt.

The prefabricated gypsum unit is installed in these standard substructures.



Einfach, schnell und sauber: Trockenbauer verschrauben den Gipskanal mit der Unterkonstruktion der Gipskartondecke.

Simple, fast and clean: Drywall contractors screw the gypsum channel onto the substructure of the gypsum plasterboard ceiling.



Passgenau: Die Leuchteinheit wird vom Elektriker in den Gipskanal eingesetzt ...

A perfect match: The lighting unit is installed in the gypsum channel by the electrician ...



... und anschließend verschraubt und elektrifiziert.

... and subsequently screwed in and wired up.



3 Die abgerundeten Kanalkonturen fügen sich randlos in die Gipskartondecke ein. Die verbleibende Wand / Decke wird mit Standard-Trockenbau-Platten verschlossen.

The rounded channel contours seamlessly fit into the gypsum plasterboard ceiling. The remaining wall / ceiling is covered with standard sheets of dry wall.



4 Anschließend werden die Fugen verspachtelt ...

Then the joints are trowelled ...



5 ... und die Gipskartondecke wird gestrichen.

... and the gypsum plasterboard ceiling is painted.



8 Die Abdeckung wird eingeklipst – fertig!

The cover is clipped on – finished!

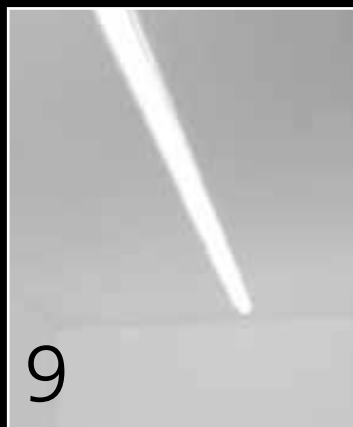

9 Alles aus einer Hand: Mit der Komplettlösung sparen Bauherren Zeit und Kosten.

Everything from one source: The complete solution saves time and money.



**Unser Ziel: Leuchten nach Maß.**

Individuelle Architektur braucht individuelle Beleuchtungslösungen – deswegen bieten wir neben unserem Standardprogramm Sonderanfertigungen, die in Dimension und Oberfläche speziell auf Ihre Projekte abgestimmt werden können. Sprechen Sie uns an!

**Our goal: Lights made to measure.**

Individual architecture requires individual lighting solutions – this is why, in addition to our standard range, we offer customised designs with dimensions and surface finish specially attuned to your projects. Please contact us!



SERVICE

# SPECIALS



## Lichtplanung Light planning

Zur Lichtberechnung steht Ihnen die Profi-Software »RELUX« zur Verfügung – fordern Sie einfach die ReluxSuite-DVD mit unseren Leuchtendaten an, oder laden Sie die jeweils aktuelle Version herunter auf [www.relux.biz](http://www.relux.biz). Gerne unterstützen wir Sie bei der lichttechnischen Planung in allen Projektphasen persönlich.

Our professional »RELUX« software is available to you for light calculation – simply order the ReluxSuite DVD with our luminaire data or download the latest version on [www.relux.biz](http://www.relux.biz). We will support you personally in technical light planning throughout all phases of your project.

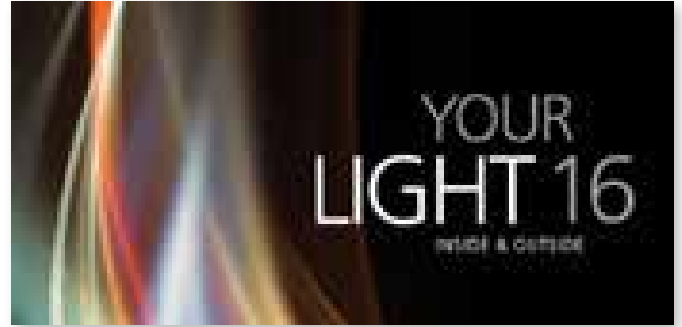

## Helestra Helestra

Mit dem Leuchtenprogramm unserer Tochterfirma Helestra bieten wir Ihnen als Ergänzung unserer Schmitz@Home Kollektion weitere designorientierte Innenleuchten sowie anspruchsvolle Außenleuchten der Marke „light is outside“.

With the lighting product range from our subsidiary Helestra, we offer additional design-oriented interior lighting products and premium “light is outside” outdoor lighting to complement our Schmitz@Home collection.



## Sonderanfertigungen nach Maß Customised designs made to measure

Maßgeschneiderte Lösungen für individuelle Planungsaufgaben: Auf Anfrage fertigen wir Leuchten in Sondergrößen nach Maß.

Tailored solutions for individual planning tasks: upon request we will produce lamps in special sizes to your specifications.



## Oberflächen in RAL-Farben Surface finish in RAL colours

Die Gehäuseoberflächen unserer Leuchten können wir auf Anfrage in fast allen RAL-Farben lackieren. So können innenarchitektonische Farbkonzepte in den Leuchtenkörpern fortgesetzt werden.

Upon request, we can paint the housing surfaces of our lights in virtually any RAL colour. This enables a perfect match of luminaires with the overall colour schemes of interior design.

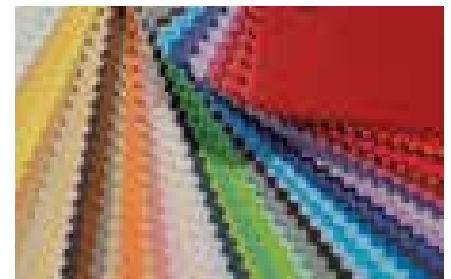

## Leuchtschirme in Sonderfarben Lamp shades in special colours

Wir bieten unsere Leuchtschirme in 30 Standardfarben an. Weitere Farben und Materialqualitäten können projektbezogen umgesetzt werden.

Our shades are offered in 30 standard colours. Additional colours and materials can be realized for special projects.



# INFORMATION

## Bitte beachten Sie:

Leuchten werden generell ohne Leuchtmittel geliefert. Konstruktionsänderungen behalten wir uns vor. Bei den Maßangaben handelt es sich um ca.-Abmessungen.

Lieferung erfolgt ab Fabrik.

Erfüllungsort und Gerichtsstand für beide Teile ist D-59823 Arnsberg. Es gelten grundsätzlich nur unsere Verkaufs- und Lieferbedingungen. Das Eigentumsrecht dieses Katalogs behalten wir uns vor.

## LED

In Schmitz LED-Leuchten werden nur hochwertige Komponenten verbaut. Trotzdem kann es innerhalb der Lebensdauer zu Ausfällen kommen. Da ein Ausfall von einigen wenigen LEDs die Funktion nicht beeinträchtigt, handelt es sich hier nicht um einen Reklamationsgrund. Sowohl bei den lichttechnischen als auch bei den elektrischen Leistungsangaben ist eine Toleranz von +/- 10 % zu beachten. Die Farbtemperatur unterliegt einer Toleranz von +/- 150 Kelvin.

Alle LED-Leuchten sind für Umgebungstemperaturen von 25 °C ausgelegt. Generell sind alle LED-Produkte für die Schaltung im ON/OFF-Modus und Steuerung mit DALI ausgelegt. Bis auf wenige Ausnahmen sind alle LED-Leuchten so aufgebaut, dass die Betriebsgeräte bzw. die LED-Module im Schadensfall ausgetauscht werden können.

Alle technischen Angaben zu LED-Leuchten beziehen sich immer auf die gesamte Leuchteneinheit.

Die aktuellsten Entwicklungen im Bereich der LED-Technologie finden Sie auf unserer Homepage.

## Ausgezeichnetes Design

Schon seit Jahren können sich Schmitz Leuchten bei renommierten nationalen und internationalen Designwettbewerben erfolgreich durchsetzen. Mehrfach ausgezeichnet für ihr herausragendes Design, verbinden Schmitz-Produkte eine anspruchsvolle Ästhetik mit großer Funktionalität und höchster Qualität.

## Please note:

Lamps are always supplied without bulbs. We reserve the right to design modifications. The measurement specifications refer to approximate dimensions.

Delivery is ex works.

Place of delivery and jurisdiction for both parties is D-59823 Arnsberg. As a rule, only our sales and supply conditions apply. We reserve ownership rights to this catalogue.

## LED

Only the best components are installed in Schmitz LEDs. On rare occasions, however, the LEDs may fail during their rated life. Since the failure of a few small LEDs does not impair overall function, their failure does not constitute grounds for a complaint. A tolerance of  $\pm 10\%$  is assumed for the rated lighting and electrical power. The color temperature is subject to a tolerance of  $\pm 150$  Kelvin.

All LED lights are designed for ambient temperatures of 25°C.

In general, all LED products are designed to be switched in ON/OFF mode and controlled by means of DALI. With a few exceptions, all LED lights are designed so that the units or LED modules can be exchanged when damaged.

All technical information regarding the LED lights always refers to the entire light unit.

Current developments in LED technology can be found on our homepage.

## Awarded Design

Schmitz Lighting has already been prevailing for a couple of years in well-known national and international design contests. Schmitz products have been awarded several times for their artistic designs. They combine a demanding aesthetic with functionality and quality of the highest standard.



DESIGN PLUS



# INDEX

Artikelnummer Article no.	Seite Page	EEC EEC	Artikelnummer Article no.	Seite Page	EEC EEC	Artikelnummer Article no.	Seite Page	EEC EEC
4100	270		18259.xxx	240	A++,A+,A	30201.xxx	187	
4160	140		18868.xxx	132	A++,A+,A,B	30202.xxx	187	
			18869.xxx	132	A+,A,B	30300.xxx	187	
6604	71		18870.xxx	132	A+,A,B	30301.xxx	187	
6606	140		18871.xxx	132	A+,A,B	30501.xxx	186	A,A+,B
			18970.xxx	78	A++,A+,A,B	30502.xxx	186	A,A+,B
			18971.xxx	78	A++,A+,A,B	30503.xxx	186	A,A+,B
<b>15000</b>			18972.xxx	86	A+,A,B	30504.xxx	186	A,A+,B
15167.xxx	80	A+,A,B	18996.xxx	106	A+,A,B	30505.xxx	186	A,A+,B
15264.xxx	246	A+,A,B,C	18997.xxx	106	A+,A,B	30506.xxx	186	A,A+,B
15270.xxx	237	A++,A+,A				30507.xxx	186	A,A+,B
15271.xxx	237	A++,A+,A	<b>25000</b>			30508.xxx	186	A,A+,B
15272.xxx	237	A++,A+,A	25266.xxx	246	A+,A,B,C	30509.xxx	186	A,A+,B
15273.xxx	237	A++,A+,A	25267.xxx	72	A+,A,B	30510.xxx	186	A,A+,B
15288.xxx	248	A+,A,B,C	25269.xxx	72	A,B			
15289.xxx	248	A+,A,B,C	25286.xxx	250	A,B	<b>33000</b>		
15290.xxx	248	A+,A,B,C	25291.xxx	250	A,B	33001.xxx	228	
15299.xxx	99	A+,A,B	25331.xxx	216	A+,A,B	33002.xxx	228	
15300.xxx	99	A+,A,B	25334.xxx	216	A+,A,B	33003.xxx	230	
15301.xxx	99	A+,A,B	25879.xxx	128	A+,A,B	33004.xxx	230	
15302.xxx	99	A+,A,B	25880.xxx	128	A+,A,B	33133.xxx	228	A+,A,B
15337.xxx	216	A,B	25881.xxx	128	A+,A,B	33155.xxx	230	A+,A,B
15462.xxx	133	A+,A,B	25887.xxx	78	A++,A+,A,B	<b>35000</b>		
15463.xxx	133	A+,A,B	25888.xxx	78	A+,A,B	35169.xxx	80	A++,A+,A,B
15464.xxx	133	A+,A,B	25889.xxx	78	A++,A+,A,B	35268.xxx	246	A+,A,B,C
15543.xxx	237	A++,A+,A	25890.xxx	70	A+,A,B	35889.xxx	78	A++,A+,A,B
15544.xxx	237	A++,A+,A	25891.xxx	70	A,B	35988.xxx	90	A+,A,B
15856.xxx	98	A+,A,B	25989.xxx	90	A+,A,B			
15857.xxx	98	A+,A,B				<b>36000</b>		
15858.xxx	98	A+,A,B	<b>26000</b>			36212.xxx	111	A+,A,B
15859.xxx	98	A+,A,B	26209.xxx	110	A++,A+,A,B	36214.xxx	111	A+,A,B
15885.xxx	78	A,B	26210.xxx	110	A++,A+,A,B	36269.xxx	124	A++,A+,A,B
15886.xxx	78	A+,A,B	26211.xxx	110	A+,A,B	36287.xxx	83	A++,A+,A,B
15890.xxx	70	A,B	26213.xxx	110	A+,A,B			
15891.xxx	70	A+,A,B	26267.xxx	124	A++,A+,A,B	<b>40000</b>		
15990.xxx	90	A+,A,B	26268.xxx	124	A++,A+,A,B	40001.xxx	258	
			26278.xxx	75	A,B	40002.xxx	258	
<b>16000</b>			26279.xxx	75	A+,A,B	40003.xxx	258	
16079.xxx	134	A+,A,B	26284.xxx	83	A++,A+,A,B	40004.xxx	258	
16080.xxx	134	A+,A,B	26285.xxx	83	A+,A,B	40122.xxx	258	
16207.xxx	110	B	26286.xxx	83	A++,A+,A,B	40123.xxx	258	
16232.xxx	140	A+,A,B	26289.xxx	83	A+,A,B			
16234.xxx	140	A+,A,B	<b>28000</b>			<b>41000</b>		
16265.xxx	124	A	28103.xxx	96	A++,A+,A,B	41001.xxx	270	
16266.xxx	124	A	28104.xxx	96	A++,A+,A,B	41002.xxx	270	
16276.xxx	75	A,B	28105.xxx	140	A++,A+,A,B	41004.xxx	270	
16277.xxx	75	A+,A,B	28264.xxx	118	A++,A+,A,B	41005.xxx	270	
16278.xxx	83	A,B	28265.xxx	118	A+,A,B			
16282.xxx	83	A+,A,B	28266.xxx	118	A+,A,B	<b>44000</b>		
16283.xxx	83	A+,A,B	28267.xxx	118	A+,A,B	44001.xxx	254	
			28972.xxx	78	A+,A,B	44002.xxx	254	
<b>18000</b>						44003.xxx	254	
18137.xxx	102	A+,A,B	<b>30000</b>			44004.xxx	254	
18241.xxx	132	A+,A,B	30105.xxx	187		<b>45000</b>		
18246.xxx	86	A+,A,B	30120.xxx	187		45170.xxx	80	A+,A,B
18247.xxx	86	A,B	30122.xxx	187		45173.xxx	224	A+,A,B
18248.xxx	86	A++,A+,A,B	30129.xxx	187		45174.xxx	224	A+,A,B
18252.xxx	240	A++,A+,A	30132.xxx	187		45332.xxx	217	A++,A+,A,B
18253.xxx	240	A++,A+,A	30135.xxx	187		45545.xxx	118	A+,A,B
18254.xxx	240	A++,A+,A	30200.xxx	187		45913.xxx	78	A+,A,B
18255.xxx	166	A++,A+,A						
18257.xxx	240	A++,A+,A						
18258.xxx	240	A++,A+,A						

Artikelnummer Article no.	Seite Page	EEC EEC	Artikelnummer Article no.	Seite Page	EEC EEC	Artikelnummer Article no.	Seite Page	EEC EEC
<b>46000</b>			<b>86000</b>			<b>122-000-000</b>		
46270.xxx	124	A++,A+,A,B	86281.xxx	75	A++,A+,A,B	122-001-xxx	216	A++,A+,A
46288.xxx	83	A+,A,B				122-002-xxx	216	A++,A+,A
46460.xxx	116	A++,A+,A,B	<b>92000</b>			122-003-xxx	217	A++,A+,A
46461.xxx	116	A++,A+,A,B	92242	236/283		122-004-xxx	217	A++,A+,A
46462.xxx	116	A+,A,B	92245	236/283		122-005-xxx	218	A+,A,B
46463.xxx	116	A+,A,B	92246	236/283		122-006-xxx	218	A+,A,B
46464.xxx	116	A+,A,B	92247	282		122-007-xxx	218	A+,A,B
46465.xxx	116	A+,A,B	92248	282		122-008-xxx	218	A+,A,B
46466.xxx	116	A+,A,B	92249	282		122-009-xxx	218	A++,A+,A
46467.xxx	116	A+,A,B	92250	282		122-010-xxx	218	A++,A+,A
			92251	282		122-011-xxx	218	A++,A+,A
<b>48000</b>			92252	282		122-012-xxx	216	A++,A+,A
48970.xxx	86	A+,A,B	92253	282		122-013-xxx	216	
			92254	282		122-014-xxx	216	
<b>50000</b>			92255	284		122-015-xxx	216	
50002.xxx	266		92257	246		122-016-xxx	217	
50129.xxx	266		92258	246		122-017-xxx	217	
50130.xxx	266		92259	246		122-018-xxx	218	
			92266	284		122-019-xxx	218	
<b>51000</b>			92267	236		122-020-xxx	218	
51002.xxx	280		92268	283		122-021-xxx	218	
51122.xxx	280		92269	246		122-022-xxx	216	A++,A+,A
51123.xxx	280		92270	246		122-023-xxx	218	A++,A+,A
51124.xxx	280		92271	246		122-024-xxx	220	A,B
51125.xxx	280		92272	246		122-025-xxx	220	A+,A,B
51126.xxx	285		92327	283		122-026-xxx	220	A+,A,B
51127.xxx	285		92328	283		122-027-xxx	220	A++,A+,A,B
51128.xxx	285		92329	283		122-028-xxx	220	A+,A,B
51131.xxx	285	A+,A,B	92330	283		122-029-xxx	221	A+,A,B
51132.xxx	285	A++,A+,A	92331	284		122-030-xxx	221	A+,A,B
51133.xxx	285	A++,A+,A				122-031-xxx	221	A+,A,B
51134.xxx	285	A+,A,B	<b>121-000-000</b>			122-032-xxx	221	A+,A,B
51135.xxx	285	A++,A+,A	121-001-xxx	68	A++,A+,A	122-033-xxx	220	A++,A+,A
51136.xxx	285	A++,A+,A	121-002-xxx	68	A++,A+,A	122-034-xxx	220	A++,A+,A
51137.xxx	285	A+,A,B	121-003-xxx	68	A++,A+,A	122-035-xxx	220	A++,A+,A
51138.xxx	285	A++,A+,A	121-004-xxx	76	A++,A+,A	122-036-xxx	220	A++,A+,A
51139.xxx	285	A++,A+,A	121-005-xxx	68	A++,A+,A	122-037-xxx	220	A++,A+,A
51140.xxx	285	A++,A+,A	121-006-xxx	76	A++,A+,A	122-038-xxx	220	A++,A+,A
51141.xxx	285	A++,A+,A	121-007-xxx	80	A++,A+,A	122-039-xxx	221	A++,A+,A
51142.xxx	285	A++,A+,A	121-008-xxx	80	A++,A+,A	122-040-xxx	221	A++,A+,A
51501.xxx	282	A+,A,B	121-009-xxx	72	A++,A+,A	122-041-xxx	221	A++,A+,A
51502.xxx	282	A+,A,B	121-010-xxx	72	A++,A+,A	122-042-xxx	221	A++,A+,A
51503.xxx	282	A+,A,B	121-011-xxx	76	A++,A+,A			
			121-012-xxx	72	A++,A+,A	<b>123-000-000</b>		
<b>52000</b>			121-013-xxx	68	A++,A+,A	123-001-xxx	154	A++,A+,A
52001.xxx	262		121-014-xxx	76	A++,A+,A	123-002-xxx	155	A++,A+,A
52002.xxx	262		121-015-xxx	76	A++,A+,A	123-003-xxx	155	A++,A+,A
			121-016-xxx	76	A++,A+,A	123-004-xxx	155	A++,A+,A
<b>65000</b>			121-017-xxx	82	A++,A+,A	123-801-xxx	155	
65283.xxx	72	A++,A+,A,B	121-018-xxx	82	A++,A+,A			
65333.xxx	217	A+,A,B	121-019-xxx	82	A++,A+,A	<b>124-000-000</b>		
65889.xxx	70	A++,A+,A,B	121-020-xxx	82	A++,A+,A	124-001-xxx	96	A++,A+,A
			121-021-xxx	74	A++,A+,A	124-002-xxx	96	A++,A+,A
<b>66000</b>			121-022-xxx	74	A++,A+,A			
66280.xxx	75	A++,A+,A,B	121-023-xxx	74	A++,A+,A	<b>126-000-000</b>		
			121-024-xxx	74	A++,A+,A	126-001-xxx	198	
<b>85000</b>			121-025-xxx	80	A++,A+,A	126-002-xxx	200/254	
85284.xxx	72	A++,A+,A,B	121-026-xxx	74	A++,A+,A	126-003-xxx	202/254	
85889.xxx	70	A++,A+,A,B	121-027-xxx	76	A++,A+,A	126-004-xxx	192	
						126-011-xxx	204/211	A+,A,B
						126-012-xxx	204/211	A+,A,B

# INDEX

Artikelnummer Article no.	Seite Page	EEC EEC	Artikelnummer Article no.	Seite Page	EEC EEC	Artikelnummer Article no.	Seite Page	EEC EEC
126-013-xxx	204/211	A+,A,B	129-003-xxx	54	A++,A+,A	135-013-xxx	164	A++,A+,A
126-014-xxx	204/211	A+,A,B	129-004-xxx	56	A++,A+,A	135-014-xxx	164	A++,A+,A
126-020-xxx	205/273	A++,A+,A	129-005-xxx	56	A++,A+,A	135-017-xxx	164	A++,A+,A
126-021-xxx	205/273	A++,A+,A	129-006-xxx	54	A++,A+,A	135-018-xxx	164	A++,A+,A
126-022-xxx	205/273	A++,A+,A	129-007-xxx	54	A++,A+,A	135-019-xxx	164	A++,A+,A
126-023-xxx	205/273	A++,A+,A	129-008-xxx	54	A++,A+,A	135-020-xxx	160	A++,A+,A
126-024-xxx	205/273	A++,A+,A	129-009-xxx	56	A++,A+,A	135-021-xxx	164	A++,A+,A
126-031-xxx	205/273	A++,A+,A	129-010-xxx	56	A++,A+,A			
126-032-xxx	205/273	A++,A+,A	129-011-xxx	54	A++,A+,A	<b>136-000-000</b>		
126-033-xxx	205/273	A++,A+,A	129-012-xxx	54	A++,A+,A	136-001-xxx	178	
126-034-xxx	205/273	A++,A+,A	129-013-xxx	54	A++,A+,A	136-002-xxx	180	
126-035-xxx	205/273	A++,A+,A	129-014-xxx	56	A++,A+,A	136-003-xxx	182	
126-040-xxx	204/211	A+,A,B	129-015-xxx	56	A++,A+,A	136-004-xxx	183	
126-041-xxx	204/211	A+,A,B				136-005-xxx	178	
126-042-xxx	204/211	A+,A,B	<b>130-000-000</b>			136-006-xxx	180	
126-801-xxx	198		130-001-xxx	62	A++,A+,A	136-007-xxx	182	
126-802-xxx	201/255		130-002-xxx	62	A++,A+,A	136-008-xxx	183	
126-803-xxx	203/255		130-003-xxx	62	A++,A+,A	136-010-xxx	179	
126-804-xxx	193		130-004-xxx	62	A++,A+,A	136-011-xxx	181	
126-806-xxx	198/201					136-012-xxx	179	
126-807-xxx	203/255		<b>131-000-000</b>			136-013-xxx	181	
126-808-xxx	193		131-001-xxx	48	A++,A+,A	136-021-xxx	174	A++,A+,A
126-809-xxx	198		131-002-xxx	48	A++,A+,A	136-022-xxx	174	A++,A+,A
126-810-xxx	201/255		131-003-xxx	48	A++,A+,A	136-023-xxx	174	A++,A+,A
126-811-xxx	203/255		131-004-xxx	48	A++,A+,A	136-024-xxx	174	A++,A+,A
126-812-xxx	193					136-025-xxx	174	A++,A+,A
126-813-xxx	201/203		<b>133-000-000</b>			136-026-xxx	174	A++,A+,A
126-814-xxx	201/203		133-001-xxx	42	A++,A+,A	136-031-xxx	174	A++,A+,A
126-815-xxx	193		133-002-xxx	42	A++,A+,A	136-032-xxx	174	A++,A+,A
126-816-xxx	201/203		133-003-xxx	42	A++,A+,A	136-033-xxx	174	A++,A+,A
126-817-xxx	193		133-004-xxx	42	A++,A+,A	136-034-xxx	174	A++,A+,A
126-818-xxx	201/203		133-005-xxx	42	A++,A+,A	136-035-xxx	174	A++,A+,A
126-819-xxx	193		133-006-xxx	42	A++,A+,A	136-036-xxx	174	A++,A+,A
126-820-xxx	192/198		133-007-xxx	42	A++,A+,A	136-041-xxx	175	A++,A+,A
126-821-xxx	192/198		133-008-xxx	42	A++,A+,A	136-042-xxx	175	A++,A+,A
126-822-xxx	192/198		133-009-xxx	42	A++,A+,A	136-043-xxx	175	A++,A+,A
126-827-xxx	193		133-010-xxx	40	A++,A+,A	136-044-xxx	175	A++,A+,A
126-829-xxx	204/272		133-011-xxx	40	A++,A+,A	136-045-xxx	175	A++,A+,A
126-830-xxx	204/272		133-012-xxx	40	A++,A+,A	136-046-xxx	175	A++,A+,A
126-831-xxx	204/272		133-013-xxx	40	A++,A+,A	136-051-xxx	175	A++,A+,A
126-832-xxx	198		133-014-xxx	40	A++,A+,A	136-052-xxx	175	A++,A+,A
126-833-xxx	201/255		133-015-xxx	40	A++,A+,A	136-053-xxx	175	A++,A+,A
126-834-xxx	203/255		133-101-xxx	41		136-054-xxx	175	A++,A+,A
126-835-xxx	193		133-102-xxx	41		136-055-xxx	175	A++,A+,A
126-839-xxx	201/203		133-103-xxx	41		136-056-xxx	175	A++,A+,A
126-840-xxx	193		133-104-xxx	43		136-121-xxx	174	A++,A+,A
126-850-xxx	192/198		133-105-xxx	43		136-122-xxx	174	A++,A+,A
126-851-xxx	192/198		133-106-xxx	43		136-123-xxx	174	A++,A+,A
			133-107-xxx	43		136-124-xxx	174	A++,A+,A
			133-108-xxx	43		136-125-xxx	174	A++,A+,A
			133-109-xxx	43		136-126-xxx	174	A++,A+,A
<b>128-000-000</b>						136-131-xxx	174	A++,A+,A
128-001-xxx	142	A++,A+,A,B	<b>135-000-000</b>			136-132-xxx	174	A++,A+,A
128-002-xxx	142	A++,A+,A,B	135-001-xxx	160	A++,A+,A	136-133-xxx	174	A++,A+,A
128-003-xxx	142	A++,A+,A	135-002-xxx	160	A++,A+,A	136-134-xxx	174	A++,A+,A
128-004-xxx	142	A++,A+,A	135-007-xxx	158	A++,A+,A	136-135-xxx	174	A++,A+,A
128-801-xxx	30/142	A++,A+,A	135-008-xxx	158	A++,A+,A	136-136-xxx	174	A++,A+,A
128-802-xxx	30/142	A++,A+,A	135-009-xxx	162	A++,A+,A	136-141-xxx	175	A++,A+,A
			135-010-xxx	162	A++,A+,A	136-142-xxx	175	A++,A+,A
<b>129-000-000</b>			135-011-xxx	162	A++,A+,A	136-143-xxx	175	A++,A+,A
129-001-xxx	54	A++,A+,A	135-012-xxx	162	A++,A+,A	136-144-xxx	175	A++,A+,A
129-002-xxx	54	A++,A+,A						

Artikelnummer Article no.	Seite Page	EEC EEC
136-145-xxx	175	A++,A+,A
136-146-xxx	175	A++,A+,A
136-151-xxx	175	A++,A+,A
136-152-xxx	175	A++,A+,A
136-153-xxx	175	A++,A+,A
136-154-xxx	175	A++,A+,A
136-155-xxx	175	A++,A+,A
136-156-xxx	175	A++,A+,A
136-801-xxx	178	
136-802-xxx	179	
136-803-xxx	179/181	
136-804-xxx	179/181	
136-805-xxx	182	
136-806-xxx	183	
136-807-xxx	179/181	
136-808-xxx	179/181	
136-809-xxx	180	
136-810-xxx	179/182	
136-811-xxx	181/183	
<b>137-000-000</b>		
137-001-xxx	30	A++,A+,A
137-002-xxx	28	A++,A+,A
137-003-xxx	28	A++,A+,A
137-004-xxx	30	A++,A+,A
137-801-xxx	30/142	
<b>138-000-000</b>		
138-001-xxx	210	
138-021-xxx	211	A++,A+,A
138-022-xxx	211	A++,A+,A
138-023-xxx	211	A++,A+,A
138-024-xxx	211	A++,A+,A
138-025-xxx	211	A++,A+,A
138-031-xxx	211	A++,A+,A
138-032-xxx	211	A++,A+,A
138-033-xxx	211	A++,A+,A
138-034-xxx	211	A++,A+,A
138-035-xxx	211	A++,A+,A
138-800-xxx	210	
138-801-xxx	210	
138-802-xxx	210	
<b>139-000-000</b>		
139-001-xxx	148	A++,A+,A
139-002-xxx	148	A++,A+,A
139-003-xxx	150	
139-004-xxx	150	
139-005-xxx	150	
139-006-xxx	150	
139-007-xxx	150	
139-008-xxx	151	
139-009-xxx	151	
139-010-xxx	151	
139-011-xxx	151	
139-012-xxx	151	
139-801-xxx	148	
<b>141-000-000</b>		
141-801-xxx	246	A++,A+,A



Fördergemeinschaft Gutes Licht  
Association for the Promotion  
of Good Light



Zentralverband Elektrotechnik- und  
Elektronikindustrie e. V.  
German Electrical and Electronic  
Manufacturers' Association



Deutsche Lichttechnische  
Gesellschaft e. V.  
German lighting technology society



Verband der Elektrotechnik  
Elektronik Informationstechnik e. V.  
Association for Electrical, Electronic  
and Information Technologies



Lichtforum NRW e. V.  
Light Forum NRW Association



Lichtplanung  
Light planning



Messe / Fair  
light+building  
Frankfurt, Germany  
13.03.2016 – 18.03.2016

### Legende / legend



Schutzart  
protective rating



Leuchtmittel  
lamps



Energieeffizienzklasse  
energy efficiency classification



Werkzeuglose Montage  
installation without tools



Insektendicht  
insect proof





Index nach Leuchtennamen  
auf der Klappeninnenseite.

Index by name on the back.