

Knapstein

G E R M A N Y

Inhalt: Stehleuchten · *floor lamps*
Seite · *page* 24 – 43

Stehleuchten

Leseleuchten · *reading lamps*
Seite · *page* 44 – 67

Leseleuchten

Deckenfluter · *uplights*
Seite · *page* 68 – 89

Deckenfluter

Tischleuchten · *table lamps*
Klemmleuchten · *clamp lamps*
Seite · *page* 90 – 117

Tischleuchten

Deckenleuchten · *ceiling lamps*
Seite · *page* 118 – 143

Deckenleuchten

Pendelleuchten · *pendants lamps*
Seite · *page* 144 – 163

Pendelleuchten

Wandleuchten · *wall lamps*
Bilderleuchten · *picture lamps*
Seite · *page* 164 – 189

Wandleuchten

Zubehör · *accessoires*
Seite · *page* 190 – 191

Zubehör

Leuchtmittelübersicht · *lamp overview*
Energieetikettierung · *energy labeling*
Seite · *page* 192 – 193

Leuchtmittel

Artikel/Seitenangabe · *article/page indication*
Seite · *page* 194 – 199

Artikelnummern-Schlüssel

key of article numbers

Leuchtentyp

type of lamp

41.890.03

fortlaufende Artikelnummer

continued article numbering

41.**890**.03

Oberfläche/Farbe

finish/colouring

41.890.**03**

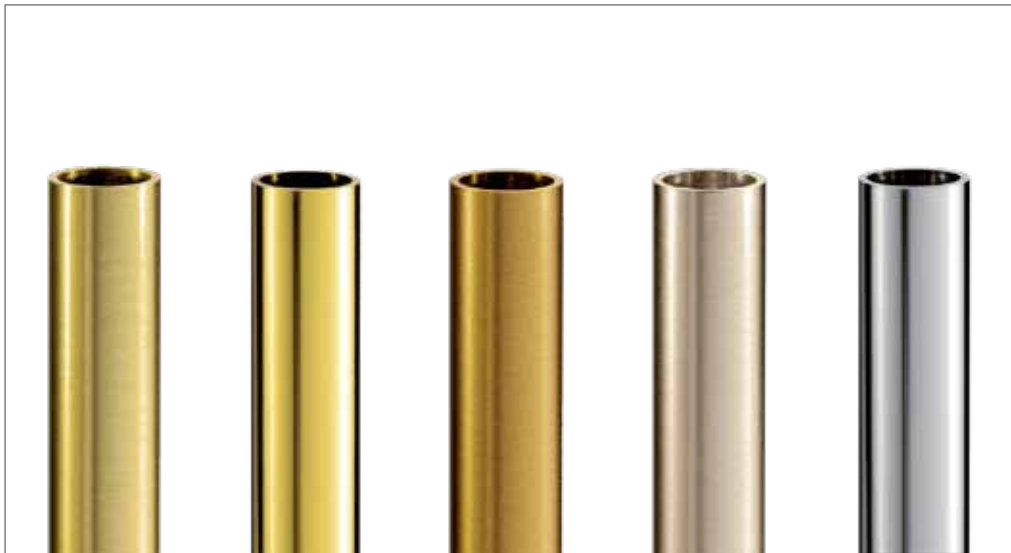

03
Messing matt,
brass dull

01
Messing poliert,
brass polished

04
bronze,
bronze

05
mattnickel,
nickel dull

06
Chrom,
chrome

Nehmen Sie sich Zeit...

Licht in Vollendung ist unser Handwerk.

Wir arbeiten für das perfekte Zusammenspiel von Tradition und Innovation, für den Einklang von Altem und Neuem.

Licht aus Meisterhand hat bei uns Tradition.

Wir bearbeiten reines Messing. Wir begreifen es und nutzen seine unendlichen Möglichkeiten, um hochwertige Wohnraum- und Objektleuchten für Sie zu fertigen.

Seit mehr als 60 Jahren verbinden wir meisterliche Handwerkskunst, moderne Technologie und zeitloses Design in vollendeter Harmonie.

Präzision und Atmosphäre.

Light in all its perfection is our business.

We work to achieve the perfect match between tradition and innovation, the compatibility of old and new.

Master-crafted light is part of our tradition.

We work with pure brass. We are able to comprehend it and make use of its endless possibilities in order to bring you high-quality living room and house lamps.

For more than 60 years we have been combining masterly, hand-crafted art, modern technology and timeless design, all in perfect harmony.

Precision and atmosphere.

...für eine gute Entscheidung



Knapstein
G E R M A N Y

Diese Leseleuchte mit Kugel- und Dreh- Kippgelenk ermöglicht eine maximale Beweglichkeit und dadurch eine gute Lichtpositionierung, bei hoher Standsicherheit. Ein besonderes Feature sind die getrennt einstellbaren Möglichkeiten der Lichtfarbe und Helligkeit. Die Leuchte wird mit separatem Stecker geliefert.

This reading light with a ball-and-trick tilting joint allows a maximum in mobility and thereby a good light positioning with high stability of the lamp. A special feature are the separately adjustable possibilities in light colour and brightness. The lamp is delivered with a separate plug.















Knapstein Leuchten im Golfhotel
Les Hauts de Gstaad & Spa, CH - Saanenmöser









Knapstein Leuchten im relexa hotel, München
Konzeption und Design:
Angelika Dreyer, Berlin
Annette Oberwittler, Nottuln



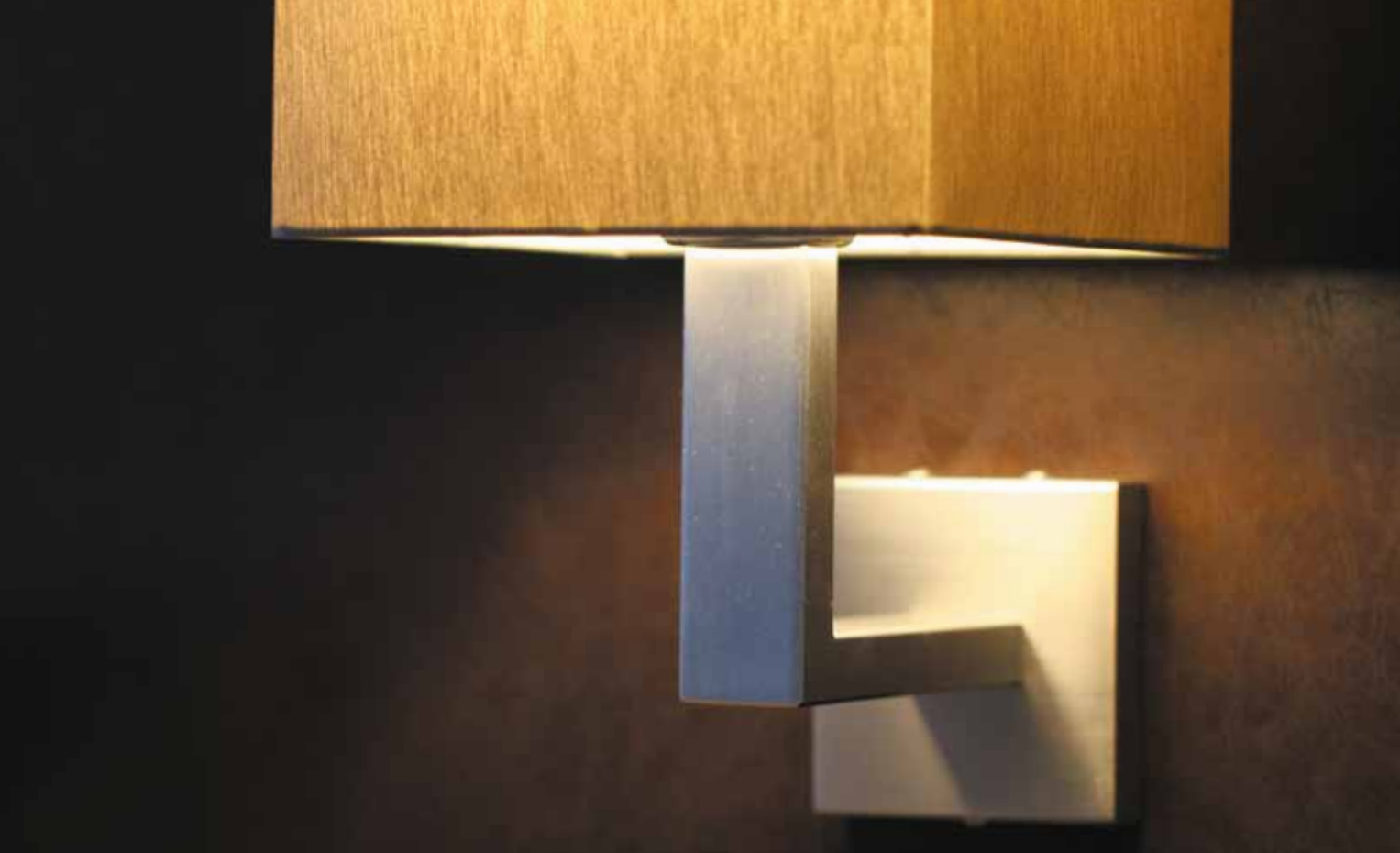

Knapstein Leuchten im »Hotel im Schulhaus«, Lorch am Rhein





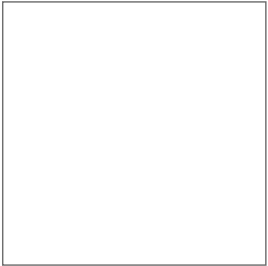

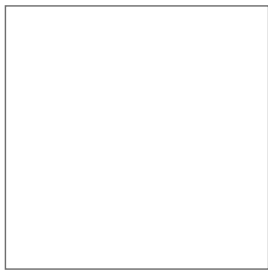
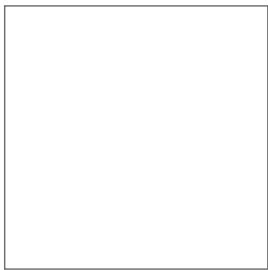



41.950.05 LED

24 W LED-Stripe
2.700 K, 1.900 lm
Energieeffizienzklasse A
Energy Efficiency Class A
mit Tastdimmer
with touch dimmer
Schaft dreh- und schwenkbar
shaft rotatable and pivotable

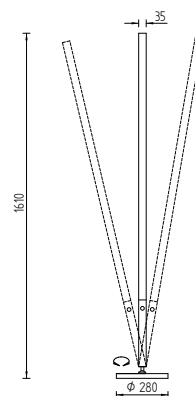

41.952.03-xx Messing matt, brass dull

41.952.05-xx mattnickel, nickel dull

Uplight:
13 W LED
2.900 K, 2.000 lm

Zentral / central
20 W LED
2.700 K, 1.500 lm

Lesearm / reading lamp
8,5 W LED
2.900 K, 965 lm

Energieeffizienzklasse A+
Energy Efficiency Class A+

Uplight und Zentrallicht
über Tastdimmer im Schaft
getrennt dimmbar
Uplight and Central separate
dimmable with touch dimmer

Leselicht über Tastdimmer im
Reflektor dimmbar
reading light
dimmable in reflector
with integrated touch dimmer

Varianten / versions

Glas opal matt weiß
glass opal dull white
41.952.xx-1

Glas opal matt amber
glass opal dull amber
41.952.xx-3

Stoffschild Chintz weiß
shade chintz white
41.952.xx-10

Stoffschild Chintz dark taupe
shade chintz dark taupe
41.952.xx-11

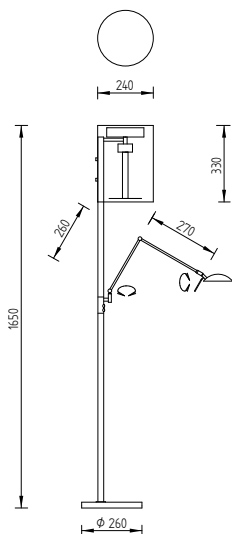



41.933.05-1

41.933.03-xx

Messing matt, brass dull

41.933.05-xx

mattnickel, nickel dull

1 x R 7 S (78 mm) max. 120 W ECO incl.
1 x E 27 max. 100 W Halolux ECO
und 1 x GY 6,35 12V, 50W incl.

R 7 S + E 27 getrennt schaltbar
mit Zugschalter

R 7 S + E 27 separate switchable
with pullswitch

alle Lichtquellen mit Tastdimmer
getrennt dimmbar
all sources of light separate dimmable
with touch dimmer

Varianten / versions

Glas opal matt weiß
glass opal dull white
41.933.xx-1

Glas opal matt amber
glass opal dull amber
41.933.xx-3

Stoffschirm Chintz weiß
shade chintz white
41.933.xx-10

Stoffschirm Chintz dark taupe
shade chintz dark taupe
41.933.xx-11

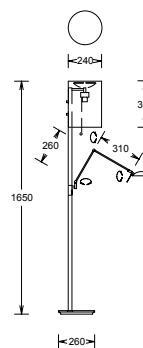

- 41.888.02-xx Messing poliert/matt
brass polished/dull
- 41.888.03-xx Messing matt, brass dull
- 41.888.05-xx mattnickel, nickel dull
- 41.888.19-xx **mattnickel/Chrom
nickel dull/chrome**
- 41.888.30-xx Messing matt/poliert
brass dull/polished

1 x R 7 S (78 mm) max. 120W ECO incl.
 1 x E 27 max. 100W Halolux ECO
 und 1 x GY 6,35 12V, 50W incl.
 R 7 S + E 27 getrennt schaltbar
 mit Zugschalter
 R 7 S + E 27 separate switchable
 with pullswitch
 alle Lichtquellen mit Tastdimmer
 getrennt dimmbar
 all sources of light separate dimmable
 with touch dimmer

Varianten / versions

- Glas opal matt weiß
glass opal dull white
41.888.xx-1
- Glas opal matt amber
glass opal dull amber
41.888.xx-3
- Stoffschirm Chintz weiß
shade chintz white
41.888.xx-10
- Stoffschirm Chintz dark taupe
shade chintz dark taupe
41.888.xx-11

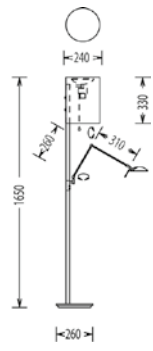

41.888.19-1

41.953.03-xx

Messing matt, brass dull

41.953.05-xx

mattnickel, nickel dull



41.953.05-1 LED

Uplight:
13 W LED
2.900 K, 2.000 lm

Zentral / central
20 W LED
2.700 K, 1.500 lm

Energieeffizienzklasse A+
Energy Efficiency Class A+

Uplight und Zentrallicht
über Tastdimmer im Schaft
getrennt dimmbar
Uplight and Central separate
dimmable with touch dimmer

Varianten / versions

Glas opal matt weiß
glass opal dull white
41.953.xx-1

Glas opal matt amber
glass opal dull amber
41.953.xx-3

Stoffschirm Chintz weiß
shade chintz white
41.953.xx-10

Stoffschirm Chintz dark taupe
shade chintz dark taupe
41.953.xx-11

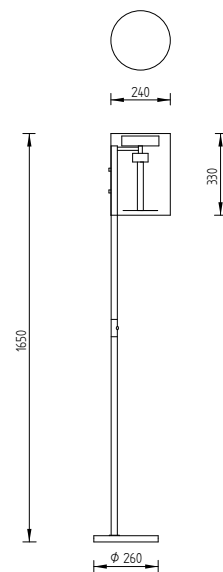

41.956.03-xx

Messing matt, brass dull

41.956.05-xx

mattnickel, nickel dull

Uplight:

16 W LED

2.700 K, 1.590 lm

Zentral / central

1 x E 27 Fassung

für schraubbares LED

for E 27 LED

Energieeffizienzklasse A+

Energy Efficiency Class A+

Uplight und Zentrallicht
über Zugserienschalter einzeln
schaltbar

Uplight and Central separate
switchable with pull switch

Varianten / versions

Glas opal matt weiß

glass opal dull white

41.956.xx-1

Glas opal matt amber

glass opal dull amber

41.956.xx-3

Stoffschild Chintz weiß

shade chintz white

41.956.xx-10

Stoffschild Chintz dark taupe

shade chintz dark taupe

41.956.xx-11

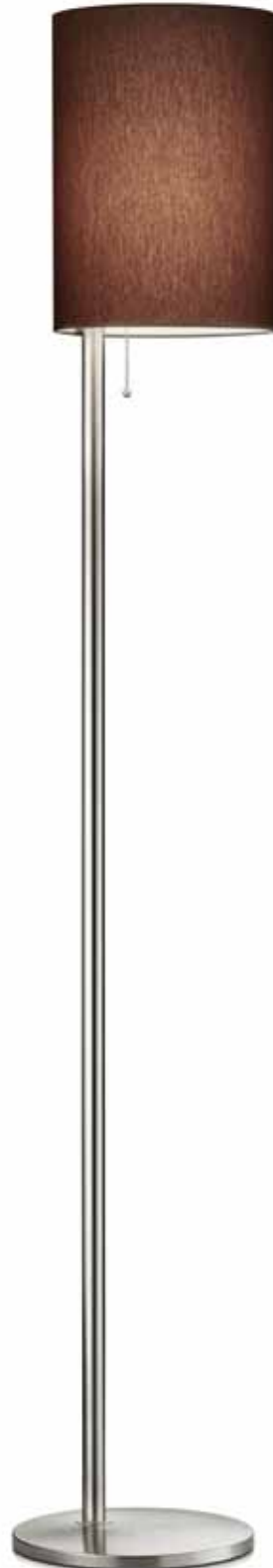
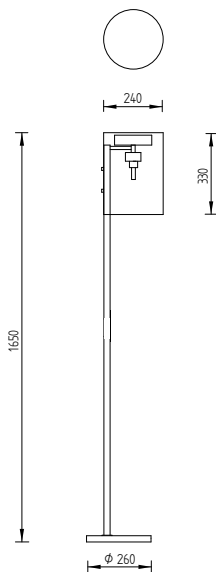

41.956.05-11 LED

Stehleuchten · floor lamps



- 41.890.03-xx Messing matt, brass dull
- 41.890.05-xx **mattnickel, nickel dull**
- 41.890.19-xx mattnickel/Chrom
nickel dull/chrome
- 41.890.30-xx Messing matt/poliert
brass dull/polished

1 x R 7 S (78 mm) max. 120W
ECO incl.
1 x E 27 max. 100W Halolux ECO
R 7 S + E 27 getrennt schaltbar mit
Zugschalter
R 7 S + E 27 separate
switchable with pullswitch
dimmbar mit Tastdimmer
dimmable with touch dimmer

Varianten / versions

Glas opal matt weiß
glass opal dull white
41.890.xx-1

Glas opal matt amber
glass opal dull amber
41.890.xx-3

Stoffschirm Chintz weiß
shade chintz white
41.890.xx-10

Stoffschirm Chintz dark taupe
shade chintz dark taupe
41.890.xx-11

41.890.05-1

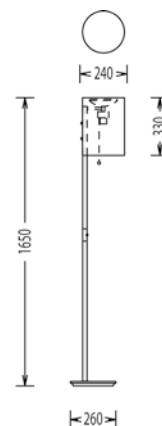

41.894.05 mattnickel, nickel dull

1 x E 27 max. 100W Halolux ECO
mit Fußtastdimmer
with touch dimmer
Glas opal matt weiß
glass opal dull white

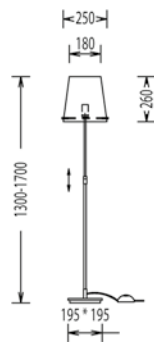

41.894.05

41.947.05 mattnickel, nickel dull

1 x E 27 max. 77W Halogen
Classic ECO
mit Fußtretschanter
with switch
Schirm, shade
Chintz weiß, white
25x25/50 cm

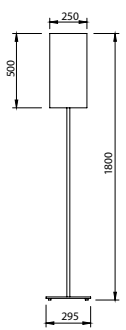

41.947.05



Das klassische Dreibein steht immer und überall auf jedem Fussboden. Mit unserem Tastdimmer versehen, läßt sich das Licht auf die gewünschte Helligkeit dimmen. Diese Leuchte ist immer ein Blickfang ob ein- oder ausgeschaltet. Der textile Schirm gibt der Stehleuchte eine wohnliche Atmosphäre. Kein störendes Kabel im oberen Leuchtenbereich. Wie bei allen Knapstein Produkten haben Sie auch hier die Möglichkeiten für Sonderwünsche. zB. Schirmfarbe etc.

41.948.05-xx mattnickel, nickel dull

41.948.06-xx Chrom, chrome

1 x E27, max. 77 W
Halogen Classic ECO
mit Tastdimmer
with touch dimmer

Varianten / versions

Schirm zylindrisch
shade cylindrical
Chintz schwarz, innen silber
chintz black, inside silver
50/50/30 cm
41.948.xx-11

Schirm zylindrisch
shade cylindrical
Chintz weiss, innen weiß
shade cylindrical
chintz white
50/50/30 cm
41.948.xx-12

Schirm konisch
shade conical
Chintz weiß, chintz white
33/42/33 cm
41.948.xx-10

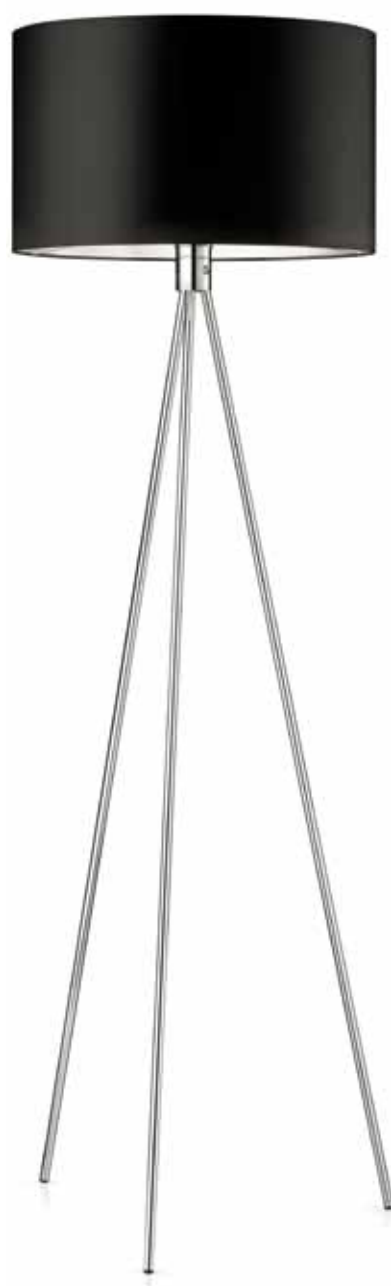

41.948.06-11



41.948.05-10

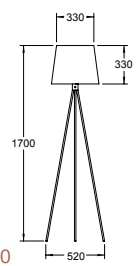
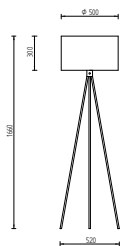



41.903.23 mattnickel, nickel dull

Schirm, shade

Chintz weiß, white

30/30/100 cm

2 x E 27

max. je 77W Halogen Classic ECO

mit Fußstastdimmer
with touch dimmer

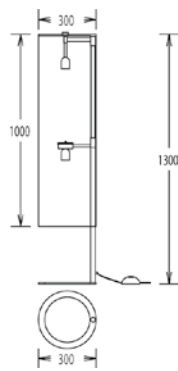

41.903.23

41.850.03-xx Messing matt, brass dull

41.850.05-xx mattnickel, nickel dull

1 x E27, max. 77 W
Halogen Classic ECO

mit Fußtrittschalter
with foot switch

Varianten / versions

Schirm zylindrisch
Chintz schwarz, innen gold
shade cylindrical
chintz black, inside gold
35/35/27 cm

41.850.xx-11

Schirm zylindrisch
Chintz weiss, innen weiss
shade cylindrical
chintz white, inside white
35/35/27 cm
41.850.xx-12



41.850.03-11

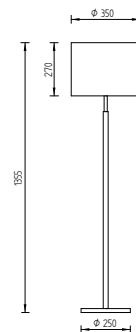

41.844.03 Messing matt, brass dull
 Schirm, shade
 Silkana crème
 28/40/24 cm

41.844.05 mattenickel, nickel dull
 Schirm, shade
 Silkana rohweiß, raw white
 28/40/24

2 x E 27 max. je 77W Halogen
 Classic ECO
 mit Zugschalter und Fußschiebedimmer,
 with pullswitch and dimmer

41.687.01 Messing poliert/Plexiglas
 brass polished/acrylic glass
 Schirm, shade
 Silkolite schneeweiß, silkolite snow
 33/58/39 cm

3 x E 27 max. je 77W Halogen Classic ECO
 + Deckenstrahler, ceiling spot
 1 x E 27 max. 100W Halolux ECO
 mit Zugschalter, with pullswitch

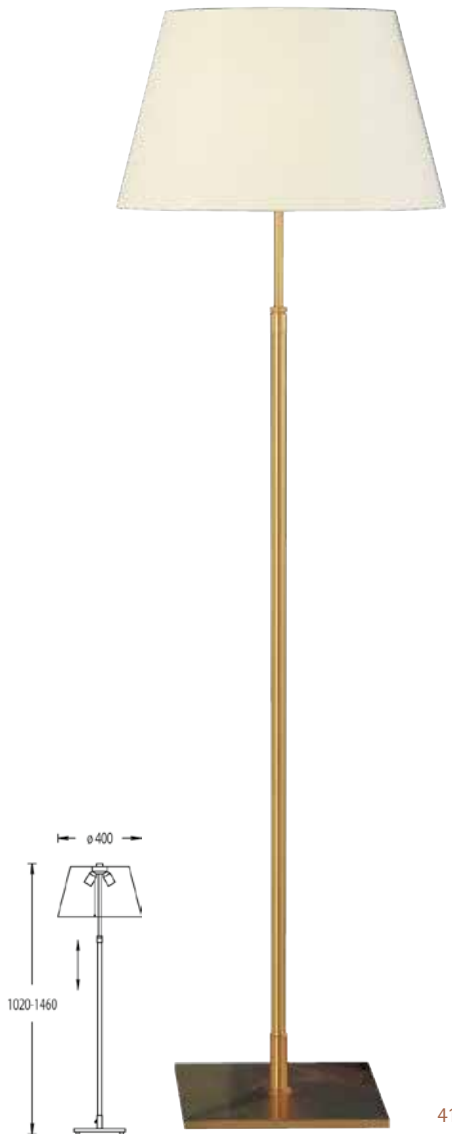

41.844.03



41.687.01

41.912.03-xx Messing matt, brass dull

41.912.05-xx mattnickel, nickel dull

2 x E 27 max. je 57W Halogen
Classic ECO

mit Zugschalter
with pullswitch

Varianten / versions

Schirm, shade
Chintz ecrü, ecru
35/35/27 cm
41.912.xx-10

Schirm, shade
Chintz weiß, white
35/35/27 cm
41.912.xx-11



41.912.05-11

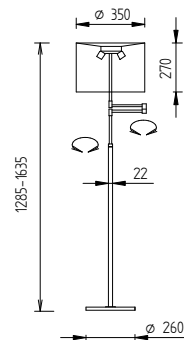

41.864.02 Messing poliert/matt
 brass polished/dull
 Schirm, shade
 Silkana beige
 33/42/31 cm

41.864.03 Messing matt, brass dull
 Schirm, shade
 Silkana crème
 33/42/31 cm

41.864.19 mattnickel/Chrom
 nickel dull/chrome
 Schirm, shade
 Silkana rohweiß, raw white
 33/42/31 cm

3 x E 27 max. je 57W Halogen
 Classic ECO
 Deckenstrahler, ceiling spot
 1 x E 27 max. 77 W Halogen
 Classic ECO
 mit Zugschalter und Fußdimmer
 with pullswitch and dimmer

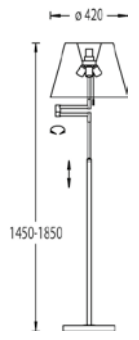

41.864.19

41.735.02 Messing poliert/matt
brass polished/dull
Schirm, shade
Silkana rohweiß, raw white
26/58/31 cm

3 x E 27 max. je 57W Halogen Classic ECO
Deckenstrahler, ceiling spot
1 x E 27 max. 77W Halogen Classic ECO
mit Dimmer am Stab,
getrennt schaltbar mit Zugschalter
with dimmer at stick,
separate switchable with pullswitch



41.735.02

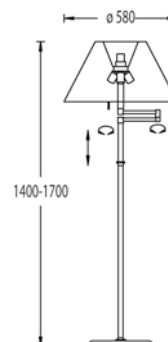

41.618.02 Messing poliert/matt
brass polished/dull
Schirm, shade
Honan ecrü, ecru
26/56/30 cm

41.618.04 bronze, bronze
Schirm, shade
Honan natur, natural
26/56/30 cm

41.618.05 mattnickel, nickel dull
Schirm, shade
Honan weiß, white
26/56/30 cm

3 x E 27 max. je 57W Halogen Classic ECO
Deckenstrahler, ceiling spot
1 x E 27 max. 77W Halogen Classic ECO
mit Zugschalter und Fußdimmer,
with pullswitch and dimmer

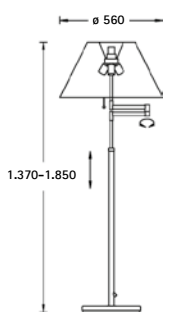

41.618.04

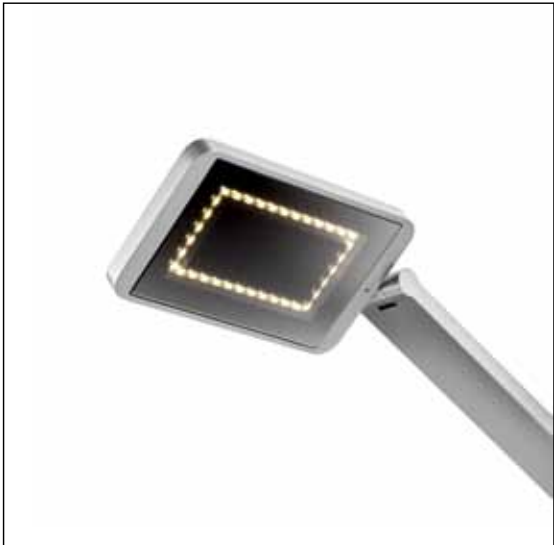
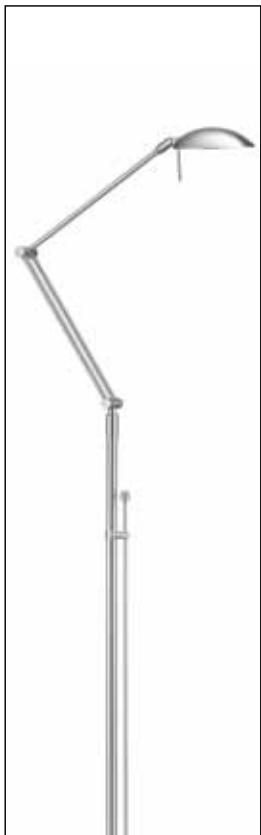
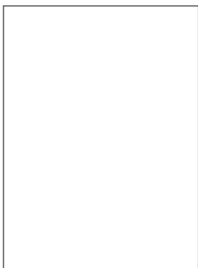

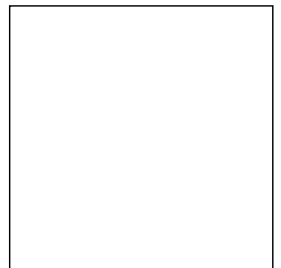
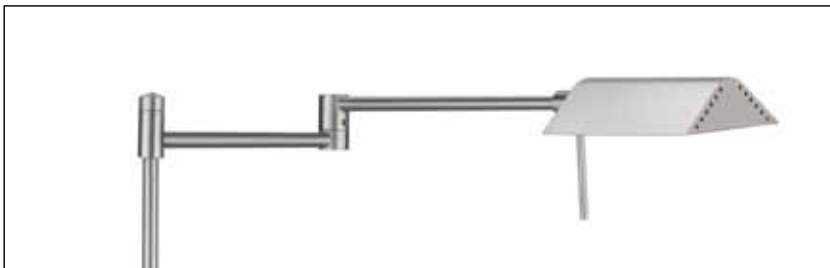



41.958.05 mattnickel, nickel dull

41.958.06 Chrom, chrome

41.958.07 schwarz, black

1 x 7 W LED, ca. 1.050 Lumen
2.900 K, (Warmton, warm white)

Energieeffizienzklasse A++
Energy Efficiency Class A++

Glas schwarz / klar
glass black / clear

mit Tastdimmer
with touch dimmer

Ausladung, range: ca. 850 mm

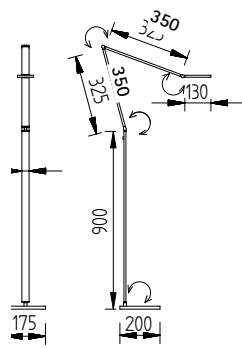

41.958.05 LED



41.958.06 LED

41.939.05 mattnickel, nickel dull

41.939.06 Chrom, chrome

2 x 3 W LED, ca. 730 Lumen
3000 K, (Warmton, warm white)

Energieeffizienzklasse A+
Energy Efficiency Class A+

mit Fußschalter
with foot switch

Reflektor seitlich drehbar
reflector lateral pivotable

Ausladung, range ca. 1000 mm



41.939.05 LED

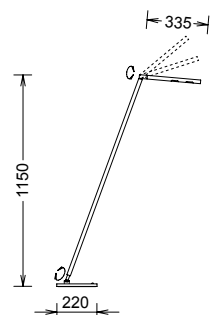

41.945.05 mattnickel, nickel dull

41.945.06 Chrom, chrome

2 x 3 W LED, ca. 730 Lumen
3000 K, (Warmton, warm white)

Energieeffizienzklasse A+
Energy Efficiency Class A+

mit Tastdimmer
with touch dimmer

Reflektor seitlich drehbar
reflector lateral pivotable

Ausladung, range: ca. 1000 mm

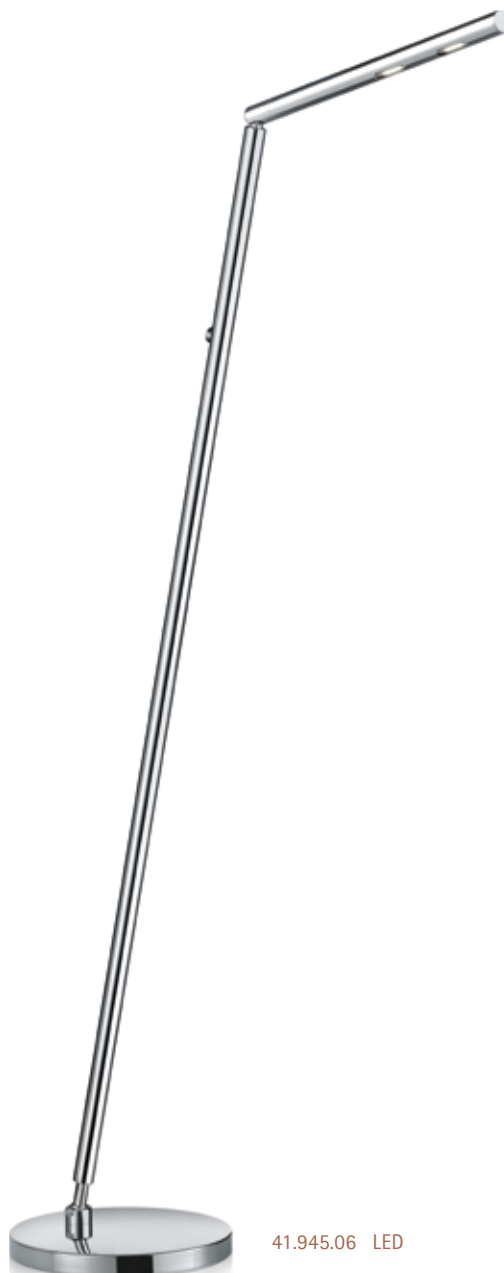
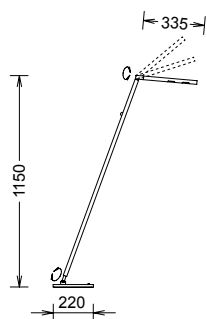



Zubehör, accessoires:
Artikel-Nr. 95.006
Glasfilter weiss satiniert
glass filter white satin

41.935.05 mattnickel, nickel dull

41.935.06 Chrom, chrome

2 x 4,5W LED, ca. 940 Lumen
2.900 K (Warmton, warm white)

Energieeffizienzklasse A+
Energy Efficiency Class A+

mit Tastdimmer
with touch dimmer

Oberseite Reflektor:
Metallfilter mit Schlitzen
metal filter with slots
on top of reflector

Ausladung, range ca. 1100 mm

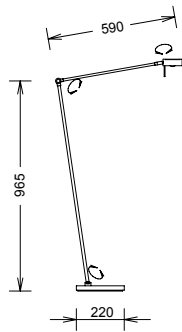

41.937.05 mattnickel, nickel dull

41.937.06 Chrom, chrome

2 x 4,5W LED, ca. 940 Lumen
2.900 K (Warmton, warm white)

Energieeffizienzklasse A+
Energy Efficiency Class A+

mit Tastdimmer
with touch dimmer

Oberseite Reflektor:
Metallfilter mit Schlitzen
metal filter with slots
on top of reflector

Ausladung, range ca. 800 mm

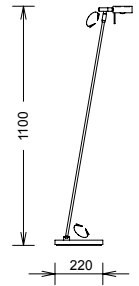

41.935.06 LED



41.937.05 LED

41.916.03 Messing matt, brass dull

41.916.05 mattenickel, nickel dull

41.916.06 Chrom, chrome

1 x 4,5 W LED, ca. 470 Lumen
2.900 K (Warmton, warm white)

Energieeffizienzklasse A+
Energy Efficiency Class A+

mit Glasabdeckung, with glasscover

mit Schalter
with switch



41.916.05 LED

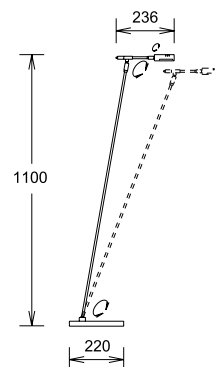

41.951.03 Messing matt, brass dull

41.951.05 mattenickel, nickel dull

8,5 W LED, ca. 840 Lumen
2.900 K (Warmton, warm white)

Energieeffizienzklasse A+
Energy Efficiency Class A+

mit Tastdimmer im Reflektor
with integrated touch dimmer
in reflector

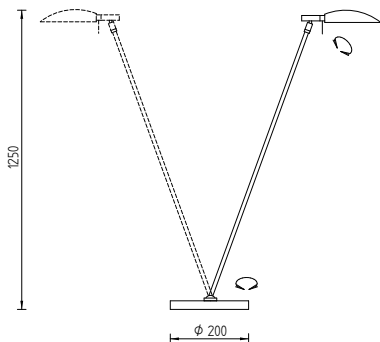

41.951.05 LED

41.946.03 Messing matt, brass dull

41.946.05 **mattnickel, nickel dull**

15 W LED, max. ca. 1.500 Lumen
mischbar von 2.700 - 5.000 K
mixable from 2.700 - 5.000 K

Energieeffizienzklasse A+
Energy Efficiency Class A+

1 Taster im Reflektor für die
Dimmung der Leuchte

1 Taster im Reflektor zur
Einstellung der Lichtfarbe

1 integrated touch dimmer in
reflector

1 integrated touch button to set
the luminous colour

Ausladung, range ca. 1.100 mm

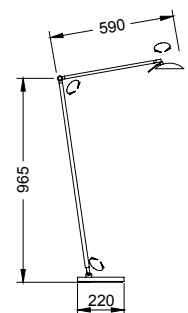

41.944.03 Messing matt, brass dull

41.944.05 mattnickel, nickel dull

2 x 2 x 4,5 W LED, 2 x ca. 940 Lumen
2.900 K, (Warmton, warm white)

Energieeffizienzklasse A+
Energy Efficiency Class A+

mit Tastdimmer je Standrohr
with touch dimmer

Ausladung, range: je ca. 950 mm

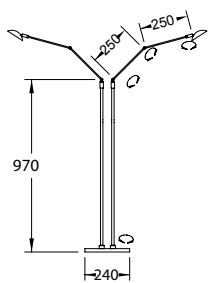

41.944.03 LED

41.957.03 Messing matt, brass dull

41.957.05 mattnickel, nickel dull

8,5 W LED, ca. 965 Lumen
2.900 K (Warmton, warm white)

Energieeffizienzklasse A+
Energy Efficiency Class A+

mit Drehdimmer
with rotary dimmer



41.957.05 LED

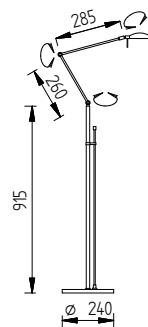

41.924.03 Messing matt, brass dull

41.924.05 mattnickel, nickel dull

41.924.06 Chrom, chrome

2 x 4,5 W LED, ca. 940 Lumen
2.900 K (Warmton, warm white)

Energieeffizienzklasse A+
Energy Efficiency Class A+

mit Tastdimmer,
with touch dimmer



41.924.06 LED

41.930.03 Messing matt, brass dull

41.930.05 mattnickel, nickel dull

41.930.06 Chrom, chrome

4 x 4,5W LED, ca. 1.880 Lumen
2.900K (Warmton, warm white)

Energieeffizienzklasse A+
Energy Efficiency Class A+

mit Tastdimmer,
with touch dimmer

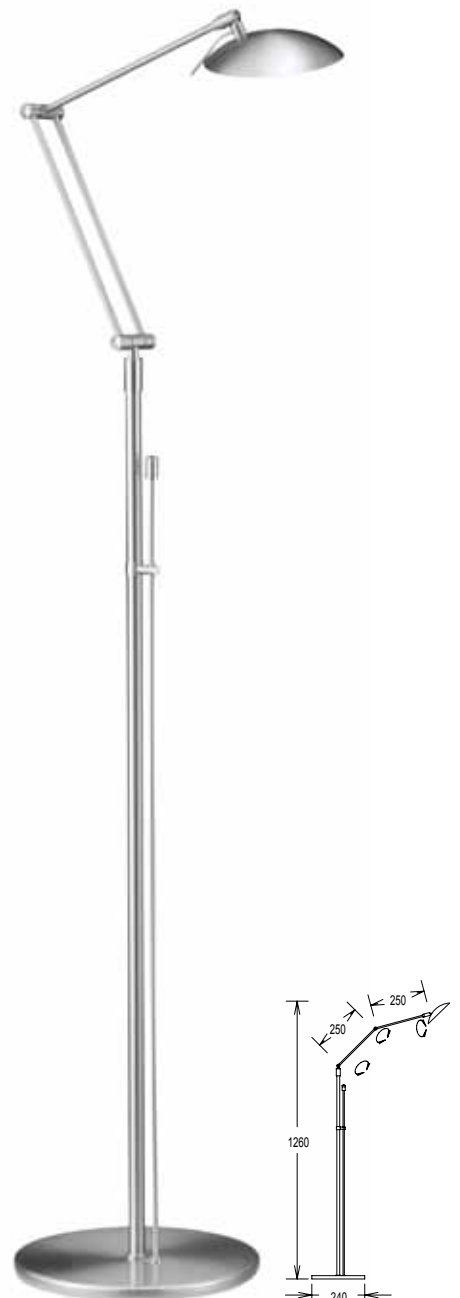

41.930.05 LED

41.791.03 Messing matt, brass dull

41.791.05 mattnickel, nickel dull

41.791.12 schwarz/Chrom, black/chrome

1 x GY 6,35 12V, 50W incl.

mit Drehdimmer

with rotary dimmer



41.791.05



41.791.12

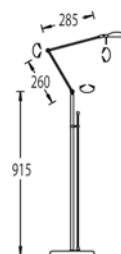

41.878.03-xx Messing matt, brass dull

41.878.05-xx mattnickel, nickel dull

41.878.06-xx Chrom, chrome

1 x GY 6,35 12V, 50W incl.

mit Tastdimmer
with touch dimmer

Glas opal matt weiß, glass white

z.B. 41.878.xx -1

Glas opal matt amber, glass amber

z.B. 41.878.xx -3



41.878.03-1



41.878.05-1

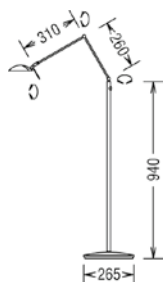

41.871.02 Messing poliert/matt
brass polished/dull

41.871.03 Messing matt, brass dull

41.871.05 mattnickel, nickel dull

1 x GY 6,35 12V, 50W incl.
mit Berührungsdimmer
with contact dimmer

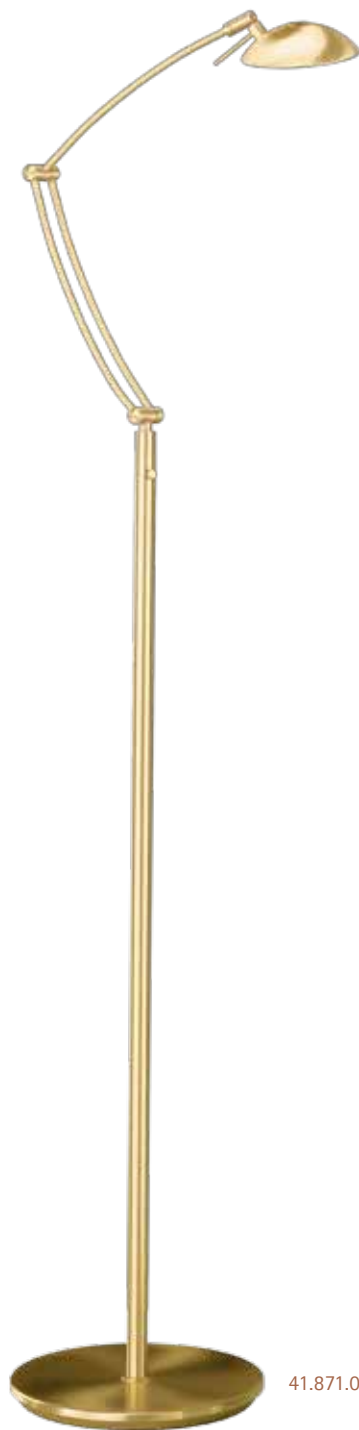

41.871.03

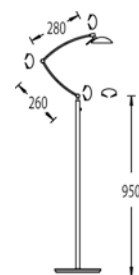

41.913.03 Messing matt, brass dull

41.913.05 mattnickel, nickel dull

1 x R 7 S (78 mm)
max. 120W ECO incl.
mit Drehdimmer
with rotary dimmer



41.851.02 Messing poliert/matt
brass polished/dull

41.851.03 Messing matt, brass dull

41.851.05 mattnickel, nickel dull

1 x R 7 S (78 mm)
max. 120W ECO incl.
mit Tastdimmer
with touch dimmer



41.949.03 Messing matt, brass dull

41.949.05 **mattnickel, nickel dull**

15 W LED, max. ca. 1.500 Lumen
mischbar von 2.700 - 5.000 K
mixable from 2.700 - 5.000 K

Energieeffizienzklasse A+
Energy Efficiency Class A+

1 Taster im Reflektor für die
Dimmung der Leuchte

1 Taster im Reflektor zur
Einstellung der Lichtfarbe

1 integrated touch dimmer in
reflector

1 integrated touch button to set
the luminous colour

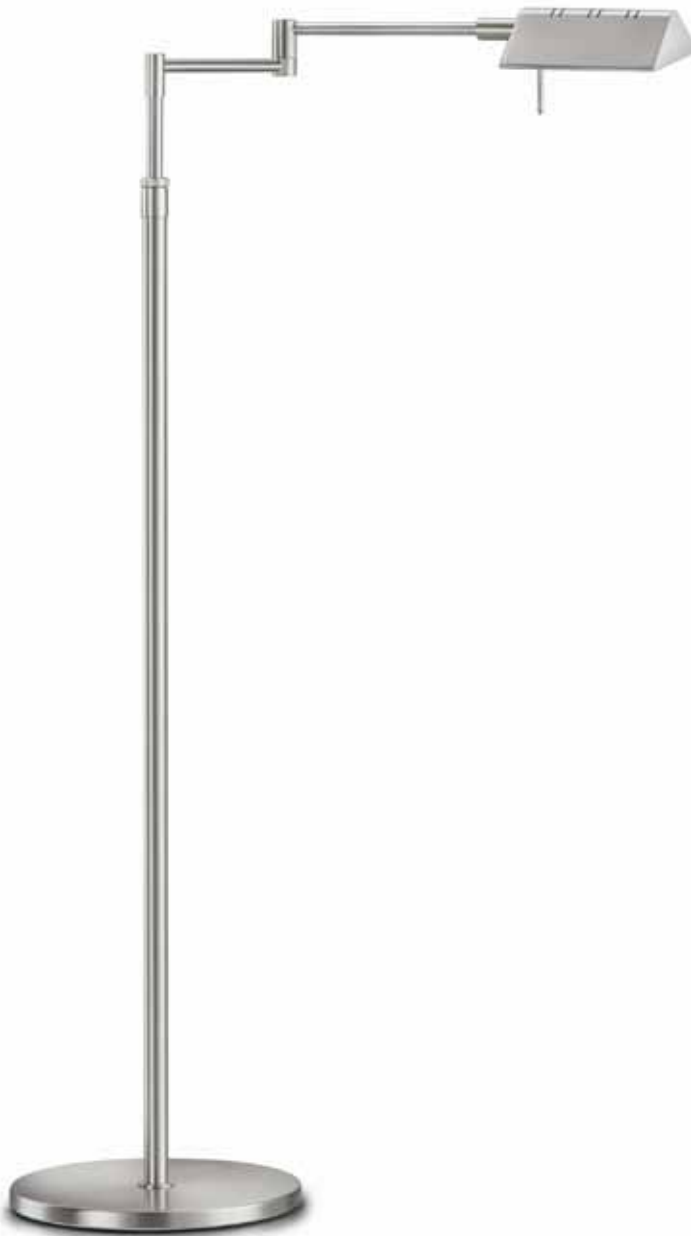

41.949.05 LED

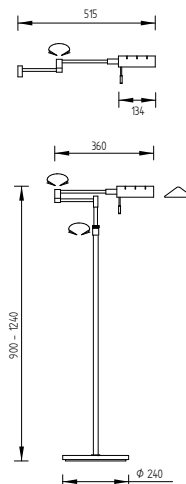

41.922.03 Messing matt, brass dull

41.922.05 mattenickel, nickel dull

41.922.06 Chrom, chrome

2 x 3 W LED, ca. 730 Lumen
3.000 K (Warmton, warm white)

Energieeffizienzklasse A++
Energy Efficiency Class A++

mit Tastdimmer,
with touch dimmer

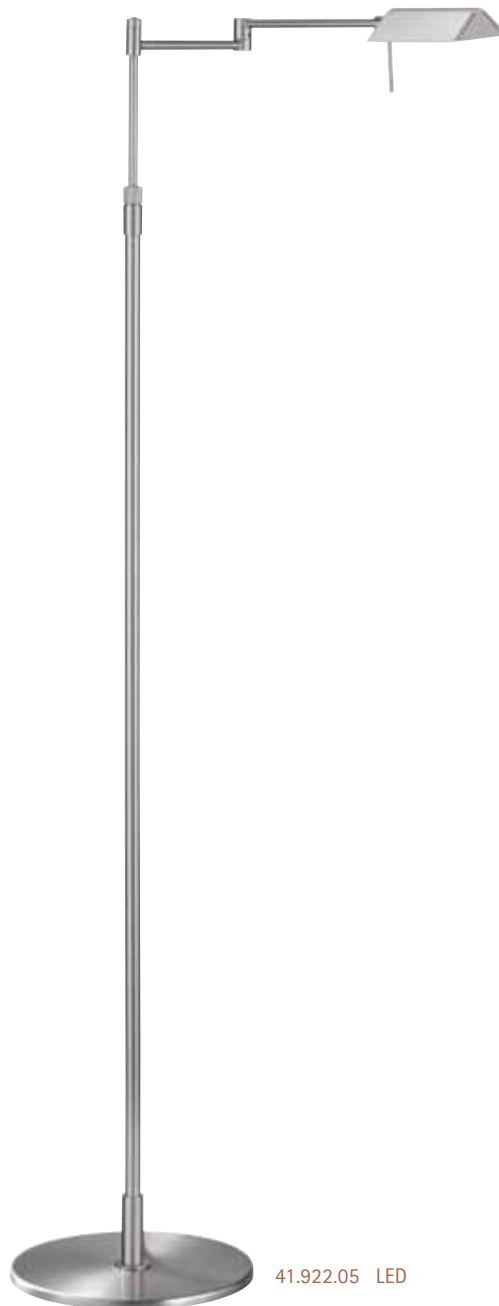
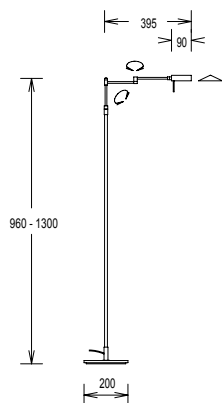

41.923.03 Messing matt, brass dull

41.923.05 mattnickel, nickel dull

41.923.06 Chrom, chrome

1 x GY 6,35 12V, 50W
Halostar ECO incl.

mit Tastdimmer
with touch dimmer

41.923.03

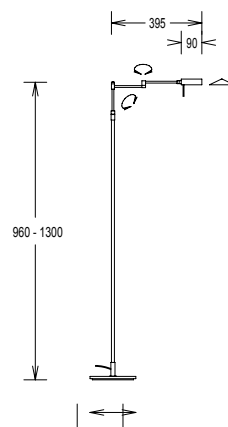

41.919.03 Messing matt, brass dull

41.919.05 mattenickel, nickel dull

41.919.06 Chrom, chrome

1 x GY 6,35 12V, 50W
Halostar ECO incl.

mit Tastdimmer
with touch dimmer

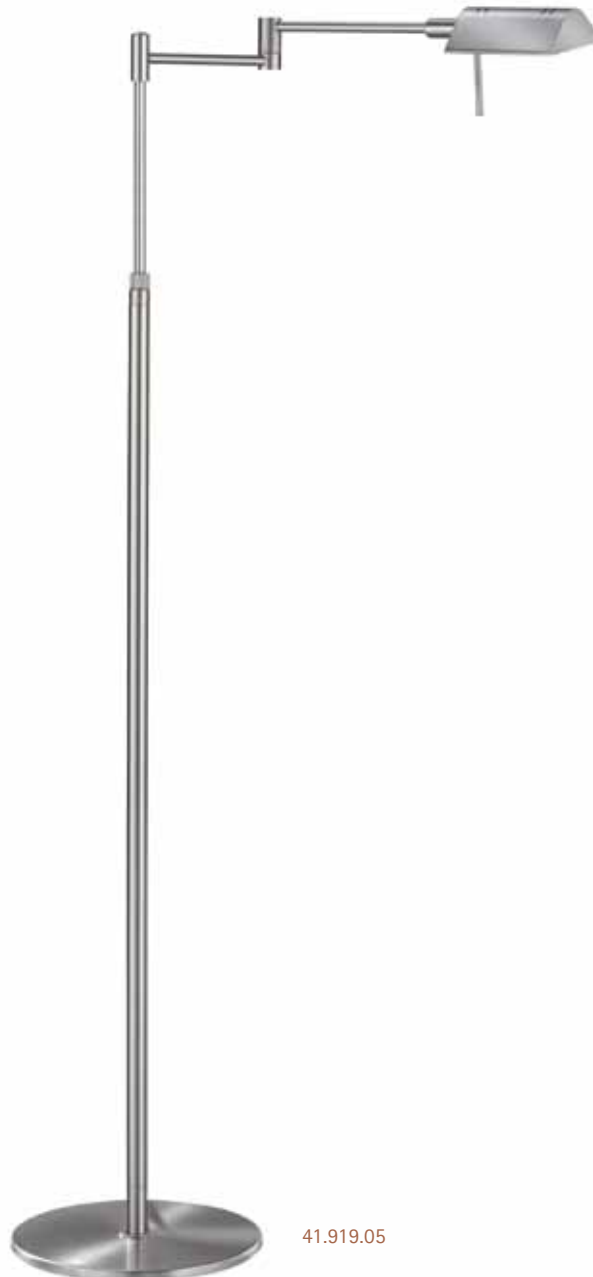
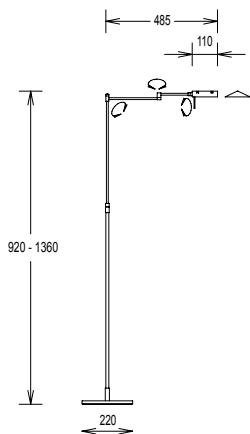

- 41.902.02 Messing poliert/matt
brass polished/dull
- 41.902.03 Messing matt, brass dull
- 41.902.05 **mattnickel, nickel dull**
- 41.902.06 Chrom, chrome

1 x B 15 d
max. 100W Halolux ECO incl.
mit Tastdimmer
with touch dimmer

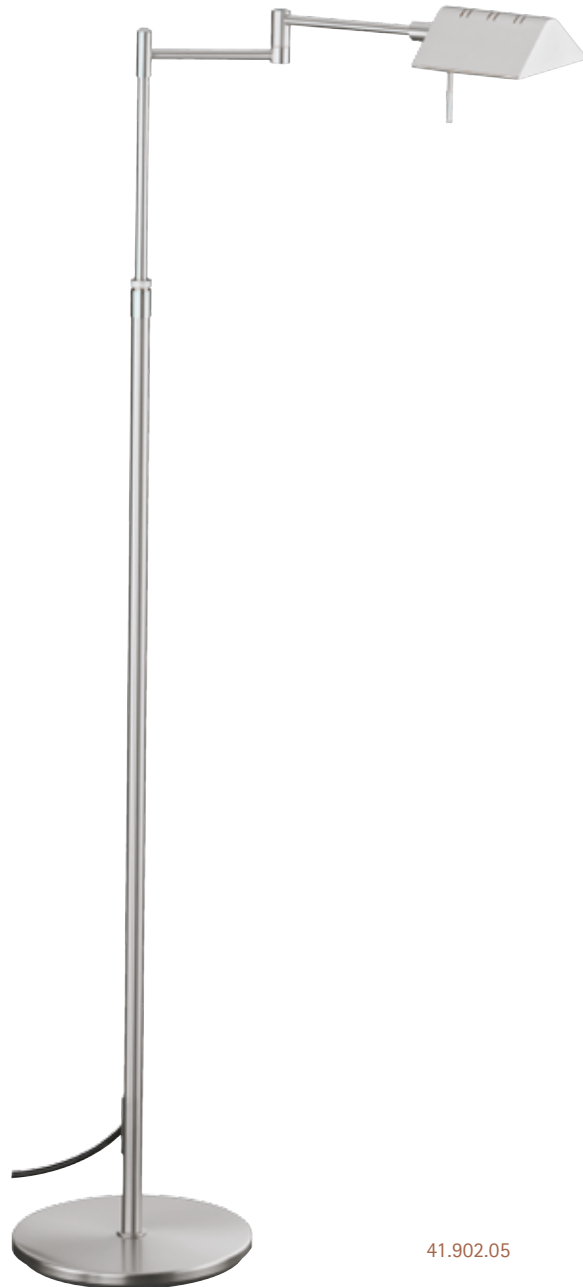

41.902.05

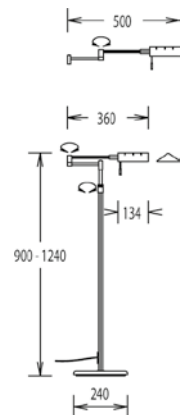

- 41.774.02 Messing poliert/matt
brass polished/dull
- 41.774.03 Messing matt, brass dull
- 41.774.04 bronze, bronze
- 41.774.05 **mattnickel, nickel dull**

1 x E 27 max. 100W
Halolux ECO

Drehdimmer am Reflektor
dimmer at reflector

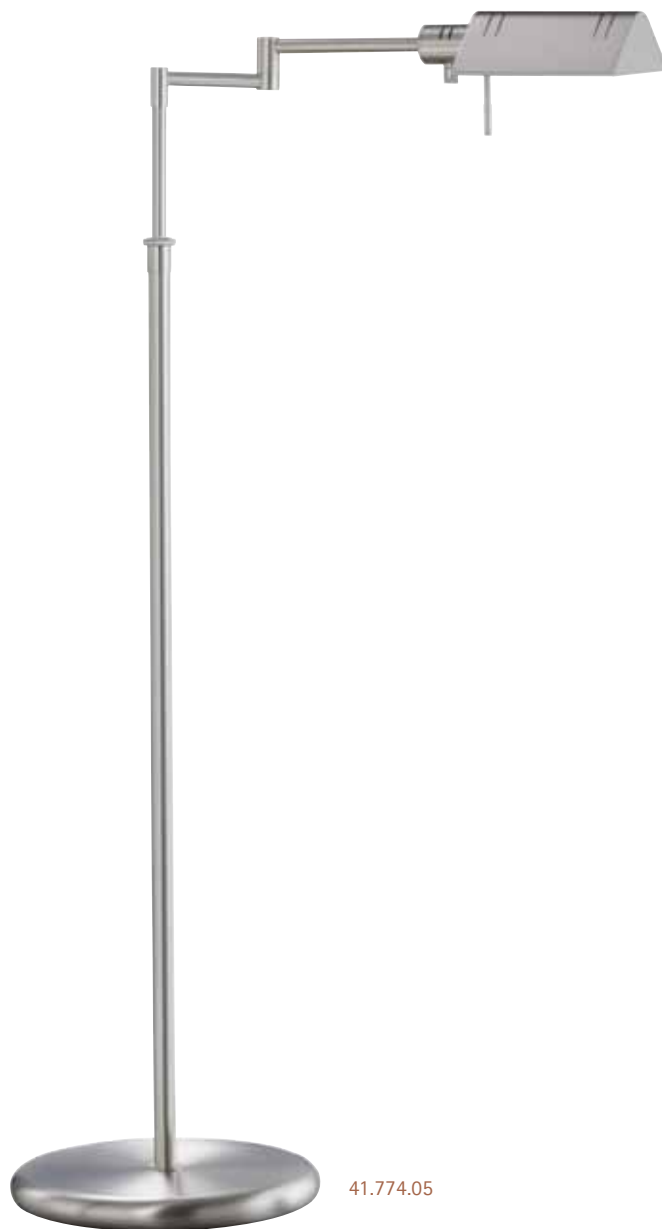
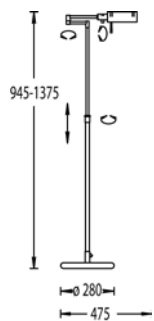

41.774.05

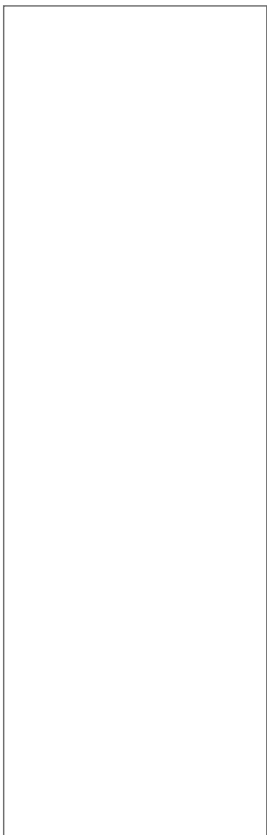
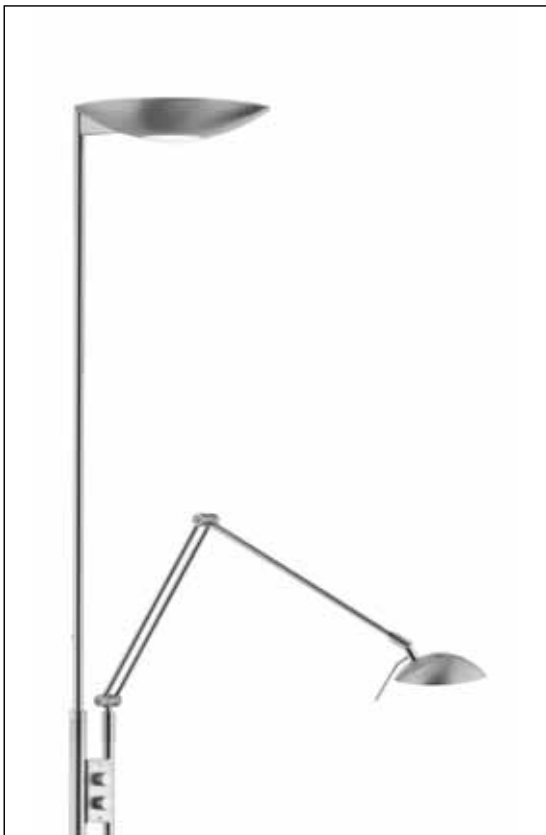

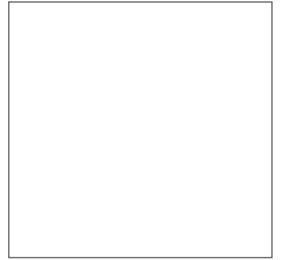
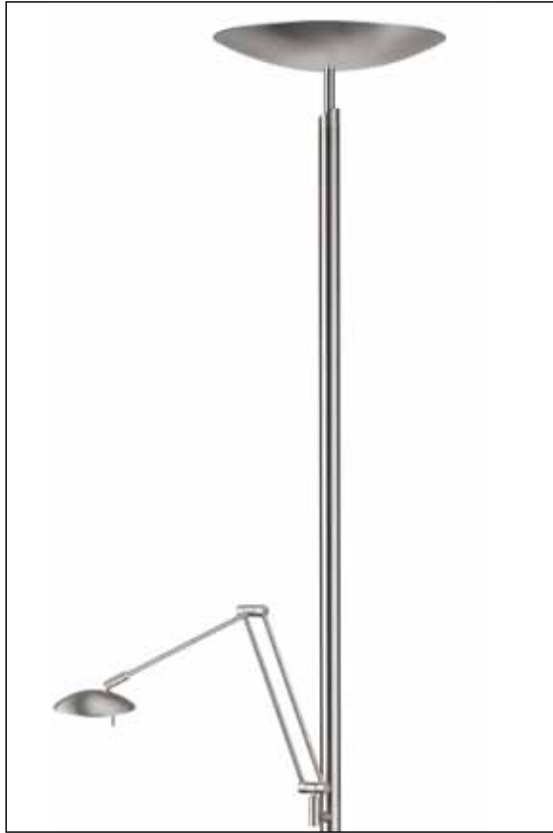

26 W LED, ca. 4.050 Lumen
2.900 K (Warmton, warm white)

Energieeffizienzklasse A++
Energy Efficiency Class A++

mit Tastdimmer,
with touch dimmer



41.959.05 LED

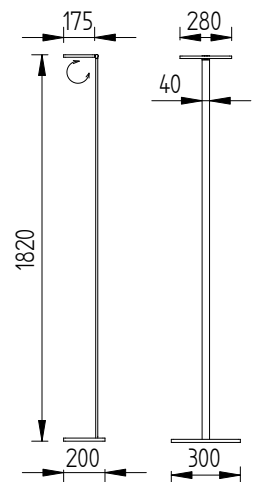





41.932.05 mattnickel, nickel dull

1 x 26 W LED, ca. 4.050 Lumen
2.900 K (Warmton, warm white)

Energieeffizienzklasse A++
Energy Efficiency Class A++

mit Tastdimmer
with touch dimmer

41.931.05 mattnickel, nickel dull

1 x R 7 S (118 mm)
max. 230W ECO incl.

mit Tastdimmer
with touch dimmer

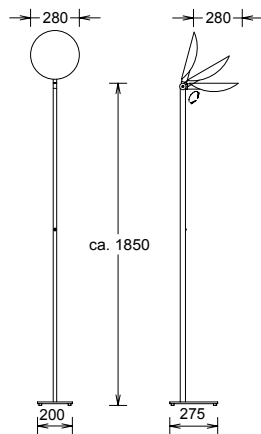

41.931.05

41.932.05 LED



41.940.03 Messing matt, brass dull

41.940.05 mattnickel, nickel dull

26 W LED, ca. 4.050 Lumen
2.900 K (Warmton, warm white)
Lesearm: 2 x 4,5 W LED, ca. 940 Lumen
2.900 K (Warmton, warm white)
Energieeffizienzklasse A++
Energy Efficiency Class A++
mit Tastdimmer, getrennt dimmbar
with touch dimmer, separate dimmable

41.942.03 Messing matt, brass dull

41.942.05 mattnickel, nickel dull

41.942.19 mattnickel/Chrom
nickel dull/chrome

26 W LED, ca. 4.050 Lumen
2.900 K (Warmton, warm white)
Energieeffizienzklasse A++
Energy Efficiency Class A++
mit Tastdimmer
with touch dimmer

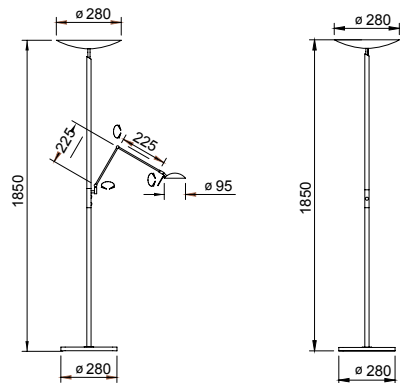

41.940.05 LED



41.942.19 LED

41.955.03 Messing matt, brass dull

41.955.05 mattnickel, nickel dull



41.955.03 LED

Uplight:
28 W LED, ca. 4.100 lm
2.700 K, (Warmton, warm white)

Lesearm / reading lamp
8,5 W LED
2.900 K, 965 lm

Energieeffizienzklasse A++
Energy Efficiency Class A++

Uplight über Tastdimmer im
Schaft getrennt dimmbar
Uplight dimmable with touch
dimmer



Leselicht über Tastdimmer im
Reflektor dimmbar
reading light dimmable in
reflector with integrated touch
dimmer

Glas opal matt weiß
glass opal dull white

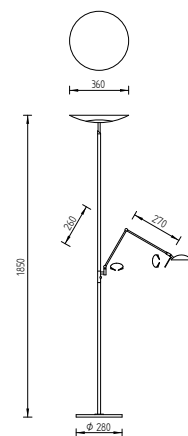

41.954.03 Messing matt, brass dull

41.954.05 mattnickel, nickel dull

28 W LED, ca. 4.100 lm
2.700 K, (Warmton, warm white)

Energieeffizienzklasse A++
Energy Efficiency Class A++

mit Tastdimmer
with touch dimmer

Glas opal matt weiß
glass opal dull white

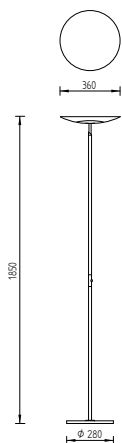

41.954.03 LED

41.962.03 Messing matt, brass dull

41.962.05 mattnickel, nickel dull

41.962.19 mattnickel, Chrom
nickel dull, chrome

Uplight:
28 W LED, ca. 4.100 lm
2.700 K, (Warmton, warm white)

Lesearm / reading lamp
8,5 W LED
2.900 K, 965 lm

Energieeffizienzklasse A++
Energy Efficiency Class A++

Uplight über Tastdimmer im
Schaft getrennt dimmbar
Uplight dimmable with touch
dimmer



Leselicht über Tastdimmer im
Reflektor dimmbar
reading light dimmable in
reflector with integrated touch
dimmer

Glas opal matt weiß
glass opal dull white

41.962.03 LED

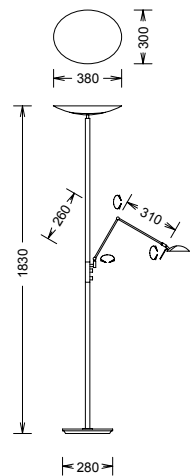

41.961.03 Messing matt, brass dull

41.961.05 mattnickel, nickel dull

41.961.19 mattnickel / Chrom
nickel dull / chrome

28 W LED, ca. 4.100 lm
2.700 K, (Warmton, warm white)

Energieeffizienzklasse A++
Energy Efficiency Class A++

mit Tasterdimmer
with touch dimmer

Glas opal matt weiß
glass opal dull white

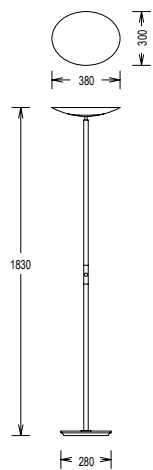

41.961.19 LED

Deckenfluter · uplights

- 41.925.03 Messing matt, brass dull
- 41.925.05 mattnickel, nickel dull
- 41.925.19 mattnickel/Chrom
nickel dull/chrome
- 41.925.30 Messing matt/poliert
brass dull/polished

1 x R 7 S (118 mm)
max. 230W ECO incl.
1x GY 6,35 12V, 50W incl.

mit Tastdimmer,
getrennt dimmbar
with touch dimmer
separate dimmable

Glas opal matt weiß
glass opal dull white



41.925.19

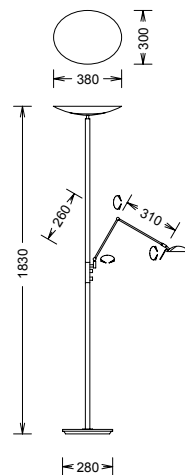

41.926.03 Messing matt, brass dull

41.926.05 mattnickel, nickel dull

41.926.19 mattnickel/Chrom
nickel dull/chrome

41.926.30 Messing matt/poliert
brass dull/polished

1 x R 7 S (118 mm)
max. 230W ECO incl.

mit Tastdimmer
with touch dimmer

Glas opal matt weiß
glass opal dull white

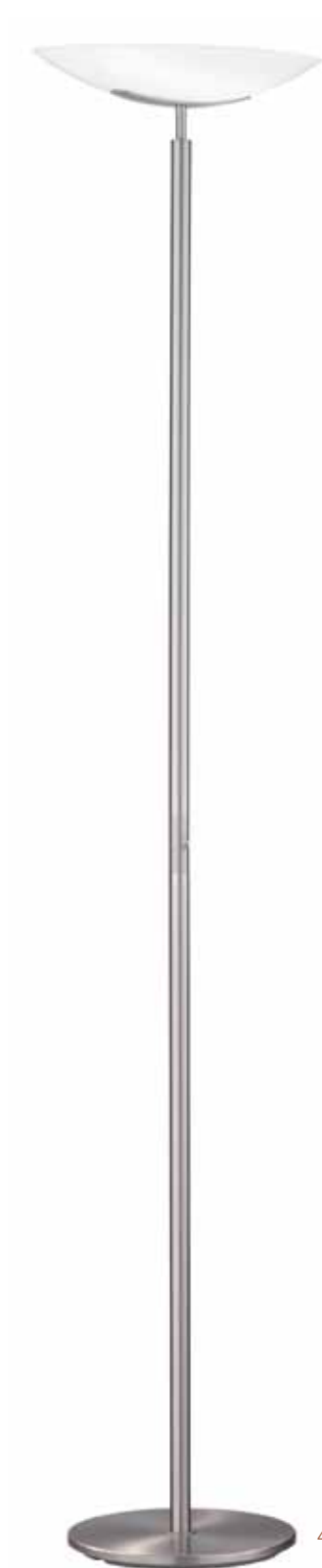
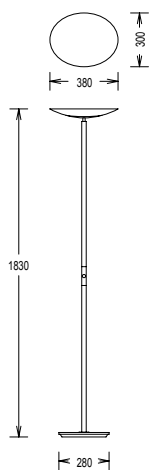

41.926.05

41.882.03 Messing matt, brass dull

41.882.05 **mattnickel, nickel dull**

1 x R 7 S (118 mm)
max. 230W ECO incl.
1 x G9 max. 60W ECO incl.

getrennt dimmbar mit
Drehdimmer
separate dimmable with
rotary dimmer

Gläser opal matt weiß
glasses opal dull white



41.882.05

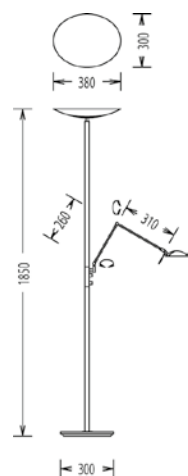

41.881.03 Messing matt, brass dull

41.881.05 mattnickel, nickel dull

1 x R 7 S (118 mm)
max. 230W ECO incl.

mit Drehdimmer
with rotary dimmer

Glas opal matt weiß
glass opal white

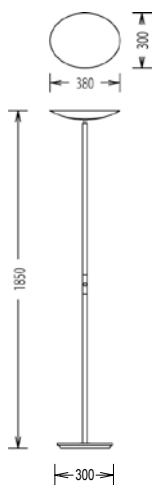

41.881.05

41.960.03 Messing matt, brass dull

41.960.05 **mattnickel, nickel dull**



Uplight:
25 W LED, ca. 4.050 lm
2.700 K (Warmton, warm white)

Lesearm / reading lamp
8,5 W LED, ca. 965 lm
2.900 K (Warmton, warm white)

Energieeffizienzklasse A++
Energy Efficiency Class A++

getrennt dimmbar mit
Drehdimmer
separate dimmable with
rotary dimmer

höhenverstellbar
height adjustable

41.960.05 LED

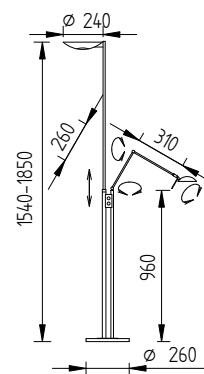

- 41.884.02 Messing poliert/matt
brass polished/dull
- 41.884.03 Messing matt, brass dull
- 41.884.05 mattenickel, nickel dull

1 x R 7 S (118 mm)
max. 230W ECO incl.
1 x G9 230V, max. 48W
Halopin ECO incl.
getrennt dimmbar mit
Drehdimmer
separate dimmable with
rotary dimmer
höhenverstellbar
height adjustable

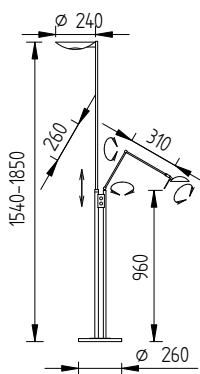

41.884.05

41.861.02 Messing poliert/matt
brass polished/dull

41.861.03 Messing matt, brass dull

41.861.04 bronze, bronze

41.861.05 mattnickel, nickel dull

1 x R 7 S (118 mm)
max. 230W ECO incl.

1 x R 7 S (78 mm)
max. 120W ECO incl.

getrennt dimmbar mit
Drehdimmer
separate dimmable with
rotary dimmer

höhenverstellbar
height adjustable



41.861.02



41.861.05

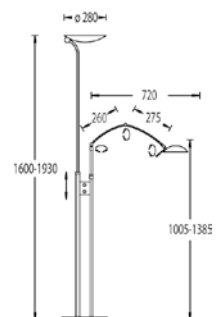

41.883.03 Messing matt, brass dull

41.883.05 mattnickel, nickel dull

1 x R 7 S (118 mm)
max. 230W ECO incl.

mit Drehdimmer,
with rotary dimmer

höhenverstellbar
height adjustable

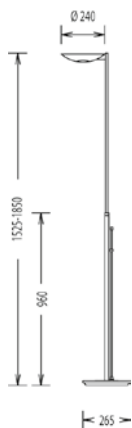

41.883.03

Deckenfluter · uplights

41.909.03 Messing matt, brass dull

41.909.05 mattnickel, nickel dull

41.909.19 mattnickel/Chrom
nickel dull/chrome

1 x E 27 max. 205W Halolux ECO
oder 18W DULUX DIM

mit Tastdimmer
with touch dimmer

Glas opal matt weiß
glass opal dull white



41.909.03



41.909.19



41.910.03 Messing matt, brass dull

41.910.05 mattnickel, nickel dull

41.910.19 mattnickel/Chrom
nickel dull/chrome

1 x E 27 max. 205W Halolux ECO
oder 18W DULUX DIM

1 x Gy 6,35, 12 V, 50 W inkl.

getrennt dimmbar mit
Tastdimmer
separate dimmable with
touch dimmer

Glas opal matt weiß
glass opal dull white

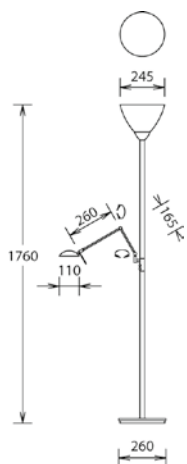

41.910.03

Tischleuchten / Klemmleuchten · *table lamps / clamp lamps*

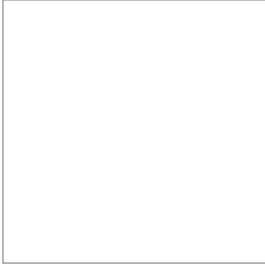
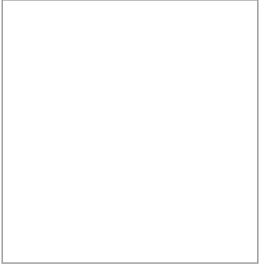
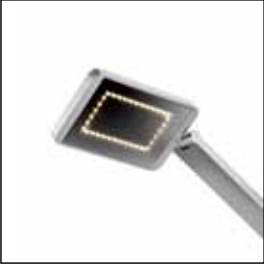
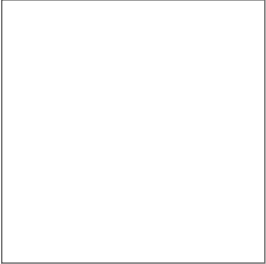

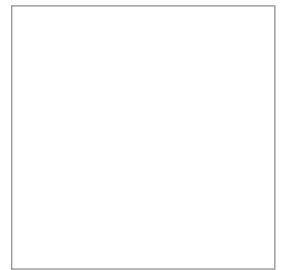



61.620.05 mattnickel, nickel dull

61.620.06 Chrom, chrome

61.620.07 schwarz, black

7 W LED, ca. 1.050 Lumen
2.900 K (Warmton, warm white)

Energieeffizienzklasse A++
Energy Efficiency Class A++

Glas schwarz / klar
glass black / clear

mit Tastdimmer
with touch dimmer

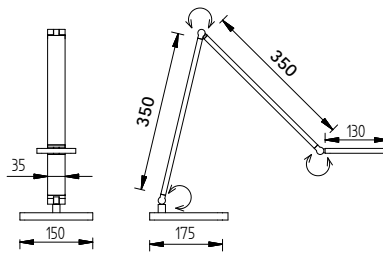

61.620.05 LED



61.620.07 LED



61.611.05 mattnickel, nickel dull

61.611.06 Chrom, chrome

2 x 3 W LED, ca. 730 Lumen
3.000 K (Warmton, warm white)

Energieeffizienzklasse A+
Energy Efficiency Class A+

mit Schalter
with switch

Reflektor seitlich drehbar
reflector lateral pivotable

Ausladung, range ca. 650 mm

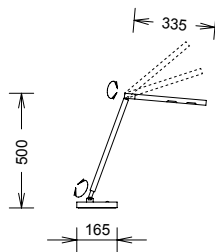

61.611.05 LED

Tischleuchten · table lamps

61.599.05 mattnickel, nickel dull

61.599.06 Chrom, chrome

1 x 4,5W LED, ca. 470 Lumen
2.900 K (Warmton, warm white)
mit Glasabdeckung, with glasscover

Energieeffizienzklasse A+
Energy Efficiency Class A+
mit Schalter
with switch

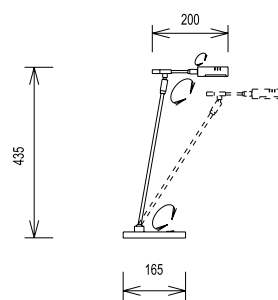

61.599.05 LED





Zubehör, accessoires:
Artikel-Nr. 95.006
Glasfilter weiss satiniert
glass filter white satin

61.608.05 mattnickel, nickel dull

61.608.06 Chrom, chrome

2 x 4,5W LED, ca. 940 Lumen
2.900 K (Warmton, warm white)

Energieeffizienzklasse A+
Energy Efficiency Class A+

Ausladung, range ca. 650 mm

mit Tastdimmer
with touch dimmer

Oberseite Reflektor:
Metallfilter mit Schlitzten
metal filter with slots
on top of reflector

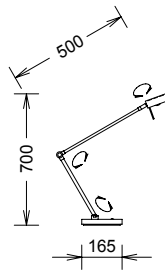

61.610.05 mattnickel, nickel dull

61.610.06 Chrom, chrome

2 x 4,5W LED, ca. 940 Lumen
2.900 K (Warmton, warm white)

Energieeffizienzklasse A+
Energy Efficiency Class A+

Ausladung, range ca. 450 mm

mit Tastdimmer
with touch dimmer

Oberseite Reflektor:
Metallfilter mit Schlitzten
metal filter with slots
on top of reflector

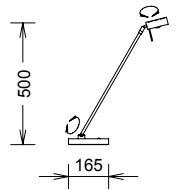

61.608.05 LED



61.610.06 LED

Tischleuchten · table lamps

61.619.03 Messing matt, brass dull

61.619.05 mattnickel, nickel dull

8,5 W LED, ca. 965 Lumen
2.900 K (Warmton, warm white)
Energieeffizienzklasse A+
Energy Efficiency Class A+
mit Drehdimmer
with rotary dimmer

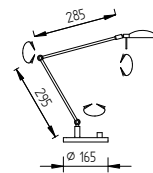

61.619.03 LED

61.605.03 Messing matt, brass dull

61.605.05 mattnickel, nickel dull

61.605.06 Chrom, chrome

4 x 4,5W LED, ca. 1880 Lumen
2.900 K (Warmton, warm white)

Energieeffizienzklasse A+
Energy Efficiency Class A+

mit Tastdimmer
with touch dimmer

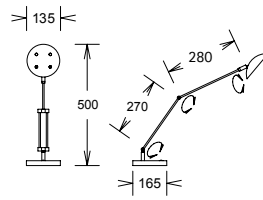

61.603.03 Messing matt, brass dull

61.603.05 mattnickel, nickel dull

61.603.06 Chrom, chrome

2 x 4,5W LED, ca. 940 Lumen
2.900 K (Warmton, warm white)

Energieeffizienzklasse A+
Energy Efficiency Class A+

mit Tastdimmer
with touch dimmer

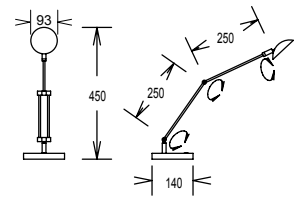

61.605.05 LED



61.603.05 LED

61.615.03 Messing matt, brass dull

61.615.05 mattnickel, nickel dull

15 W LED,
max. ca. 1.500 Lumen
mischbar von 2.700 - 5.000 K
mixable from 2.700 - 5.000 K

Energieeffizienzklasse A+
Energy Efficiency Class A+

1 Taster im Reflektor für die
Dimmung der Leuchte

1 Taster im Reflektor zur
Einstellung der Lichtfarbe

1 integrated touch dimmer in
reflector

1 integrated touch button to set
the luminous colour



61.615.05 LED

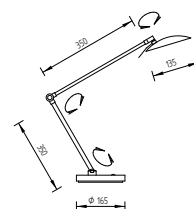

61.618.03 Messing matt, brass dull

61.618.05 mattsilber, silver dull

8,5 W LED, ca. 965 lm
2.900 K (Warmton, warm white)

Energieeffizienzklasse A+
Energy Efficiency Class A+

mit Tastdimmer im Reflektor
with integrated touch dimmer
in reflector

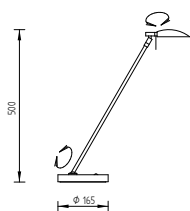

Tischleuchten · table lamps

61.505.02 Messing poliert/matt
brass polished/dull

61.505.03 Messing matt, brass dull

61.505.05 mattnickel, nickel dull

61.505.12 Chrom/schwarz,
chrome/black

1 x GY 6,35 12V, 50W incl.
mit Drehdimmer
with rotary dimmer

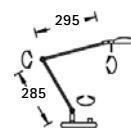

61.505.05



61.505.03

61.545.03 Messing matt, brass dull

61.545.04 bronze, bronze

61.545.05 mattnickel, nickel dull

1 x R 7 S (78 mm)
max. 120W ECO incl.
mit Tastdimmer
with touch dimmer

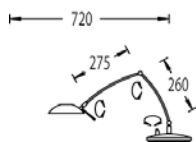

61.545.05



61.602.03 Messing matt,
brass dull

61.602.05 mattnickel,
nickel dull

2 x 3 W LED,
ca. 730 Lumen, 3.000 K
(Warmton, warm white)

Energieeffizienzklasse A+
Energy Efficiency Class A+

mit Tastdimmer
with touch dimmer

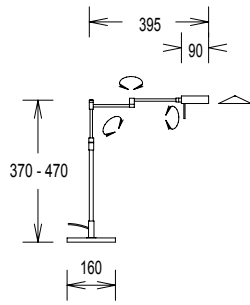

61.600.03 Messing matt,
brass dull

61.600.05 mattnickel,
nickel dull

61.600.06 Chrom, chrome

1 x GY 6,35 12V, 50W
Halostar ECO incl.

mit Tastdimmer
with touch dimmer

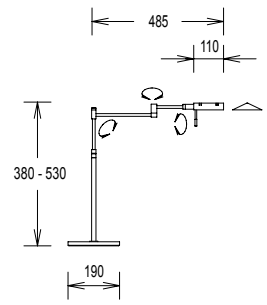

61.602.05 LED



61.600.03

Tischleuchten · table lamps

61.612.03 Messing matt, brass dull

61.612.05 mattnickel, nickel dull

2 x 3 W LED, ca. 730 Lumen
3.000 K (Warmton, warm white)

Energieeffizienzklasse A+
Energy Efficiency Class A+

mit Schalter
with switch

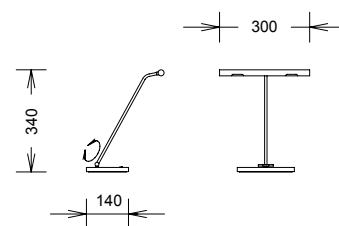

61.612.03 LED

- 61.586.02 Messing poliert/matt
brass polished/dull
- 61.586.03 Messing matt, brass dull
- 61.586.05 mattnickel, nickel dull
- 61.586.19 mattnickel/Chrom
nickel dull/chrome

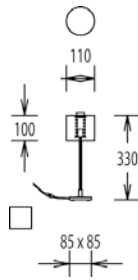

1 x Halopin G 9 230V
LED 5 W, 480 lm incl.

Energieeffizienzklasse A+
Energy Efficiency Class A+

mit Schalter in Zuleitung,
with switch in conducting cable

Glas opal matt weiß,
glass opal dull white



61.586.03 LED



61.586.19 LED

Tischleuchten · table lamps

61.606.05 mattnickel, nickel dull

Glas opal matt weiß
glass opal dull white

1 x E 27 max. 77W Halogen Classic ECO
mit Tastdimmer in Zuleitung,
with touch dimmer in conducting cable

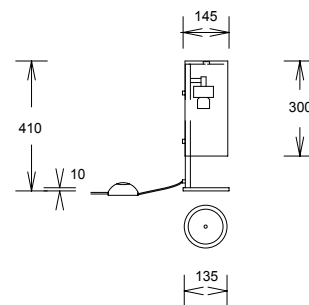

61.581.23 **Edelstahl matt**
refined steel dull
Schirm, shade
Chintz weiß, white
21/21/46 cm

1 x E 27 max. 77W Halogen
Classic ECO

mit Tastdimmer in Zuleitung
with touch dimmer in con-
ducting cable

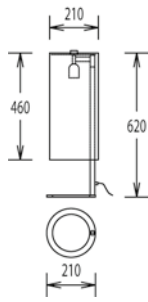

61.585.23 **Edelstahl matt**
refined steel dull
Schirm, shade
Chintz weiß, white
14/14/31 cm

1 x E 27 max. 57W Halogen
Classic ECO

mit Tastdimmer in Zuleitung
with touch dimmer in con-
ducting switch

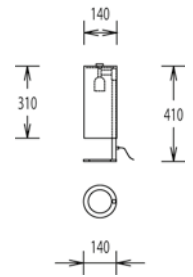

61.581.23



61.585.23

61.614.05 mattnickel, nickel dull

Schirm, shade
Chintz weiß, white
35x16/20 cm

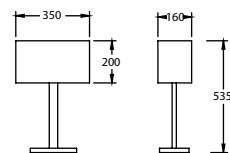

1 x E 27 max. 57W Halogen Classic ECO
mit Schalter
with switch



61.614.05

61.613.05 mattnickel, nickel dull

Schirm, shade

Chintz weiß, white

20x20/40 cm

1 x E 27 max. 57W Halogen Classic ECO

mit Schalter in Zuleitung,

with switch in conducting cable

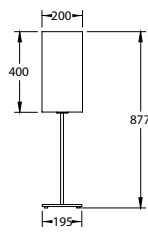

61.613.05

Tischleuchten · table lamps

71.302.02 Messing poliert/matt
brass polished/dull
Schirm, shade: Silkana beige
28/40/24 cm

71.302.03 Messing matt, brass dull
Schirm, shade: Silkana crème
28/40/24 cm

71.302.19 mattnickel/Chrom
nickel dull/chrome
Schirm, shade Silkana rohweiß, raw white
28/40/24 cm

2 x E 27 max. je 77W Halogen
Classic ECO

mit Zugschalter
with pullswitch

mit Dimmer in Zuleitung,
with dimmer in conducting cable

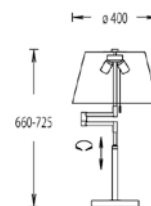

71.302.02

61.471.01 Messing poliert/Plexiglas
brass polished/acrylic glass
Schirm, shade
Silkolite schneeweiß, snow
25/37/26



1 x E 27 max. 77W Halogen
Classic ECO

mit Schalter in Zuleitung
with switch in conducting cable

61.274.01 Messing poliert,
brass polished
Schirm, shade
Chintz ecrü, ecru
19/24/17 cm oval

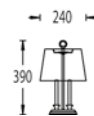

2 x E 14 max. je 46W Halogen
Classic ECO

mit Schalter in Zuleitung
with switch in conducting cable



61.471.01



61.274.01

Klemmleuchten · *clamp lamps*



11.35.03 Messing matt, brass dull

11.35.05 mattnickel, nickel dull

1 x 4,5W LED, ca. 470 Lumen
2.900 K (Warmton, warm white)

Energieeffizienzklasse A+
Energy Efficiency Class A+

mit Glasabdeckung
with glasscover

mit Schalter in Zuleitung
with switch in conducting cable

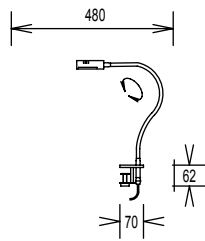

11.35.05 LED

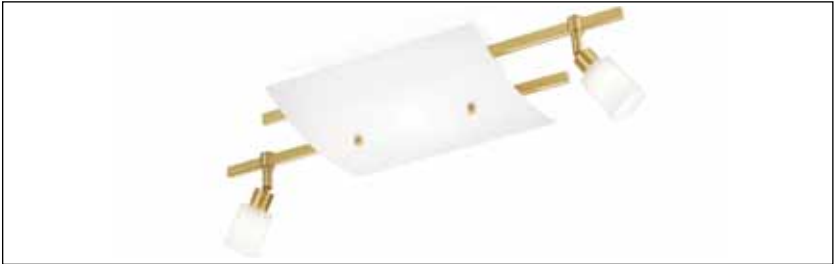
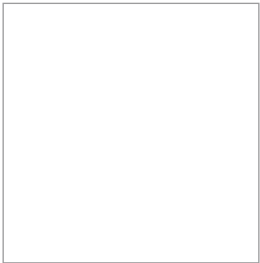
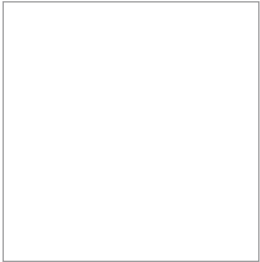

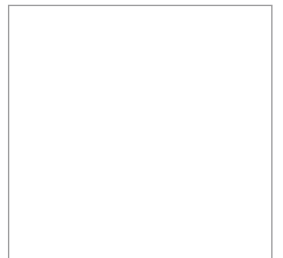
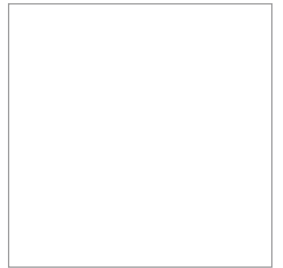
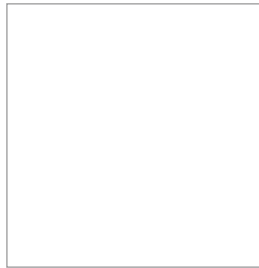
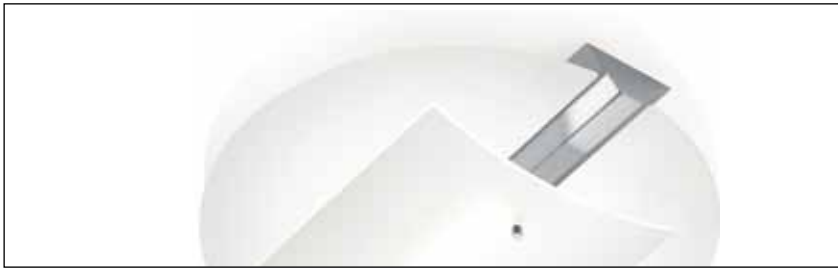

Deckenleuchten · ceiling lamps

91.312.05 mattnickel, nickel dull

91.312.51 Alu Crisp, alumin. Crisp

91.312.52 Kupfer, copper

91.312.54 Blattmetall gold,
metal foil gold

10 x 3 W LED, ca. 3.600 lm
2.700 K (Warmton, warm white)

Energieeffizienzklasse A+
Energy Efficiency Class A+

dimmbar, dimmable

Detailansicht

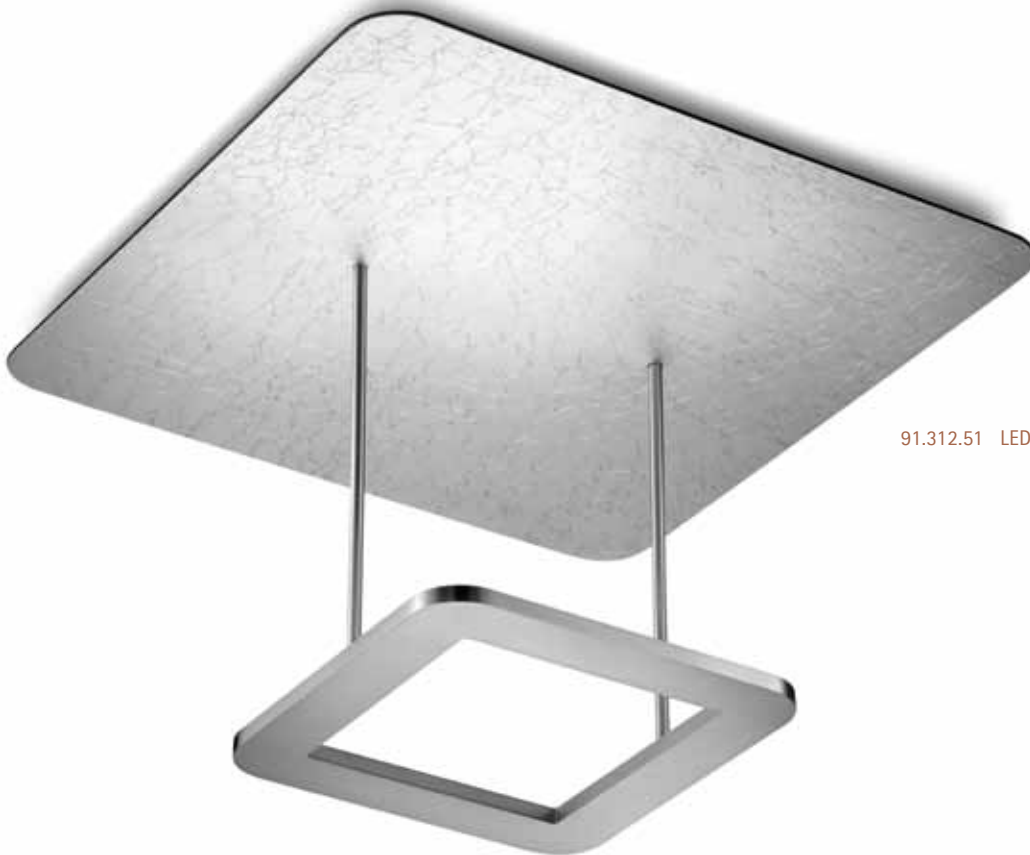

91.312.51 LED

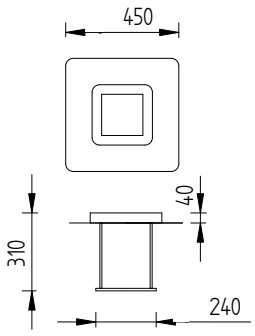

91.312.54 LED



91.313.05 LED

91.313.05 mattnickel, nickel dull

91.313.51 Alu Crisp, alumin. Crisp

91.313.52 Kupfer, copper

91.313.54 Blattmetall gold,
metal foil gold

10 x 3 W LED, ca. 3.600 lm
2.700 K (Warmton, warm white)

Energieeffizienzklasse A+
Energy Efficiency Class A+
dimmbar, dimmable

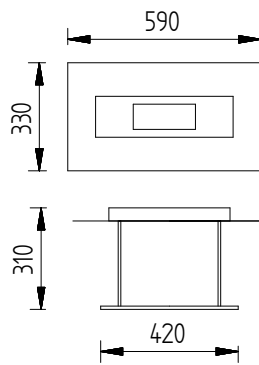

91.313.52 LED



91.328.05 mattnickel, nickel dull

4 x 8 W LED
2.700 K, 4 x 800 lm
ges. 3.200 lm
Energieeffizienzklasse A+
Energy Efficiency Class A+
dimmbar, dimmable
Strahler 180° drehbar
spotlight 180° rotatable
Glas satiniert weiß
glass satin white

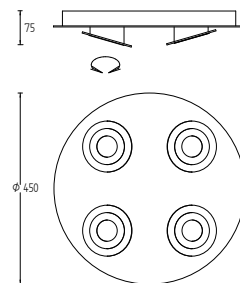

91.329.05 mattnickel, nickel dull

3 x 8 W LED
2.700 K, 3 x 800 lm
ges. 2.400 lm
Energieeffizienzklasse A+
Energy Efficiency Class A+
dimmbar, dimmable
Strahler 180° drehbar
spotlight 180° rotatable
Glas satiniert weiß
glass satin white

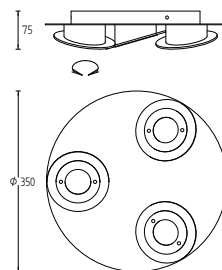

91.330.05 mattnickel, nickel dull

3 x 8 W LED
2.700 K, 3 x 800 lm
ges. 2.400 lm
Energieeffizienzklasse A+
Energy Efficiency Class A+
dimmbar, dimmable
Strahler 180° drehbar
spotlight 180° rotatable
Glas satiniert weiß
glass satin white

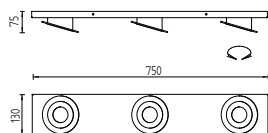

91.331.05 mattnickel, nickel dull

2 x 8 W LED
2.700 K, 2 x 800 lm
ges. 1.600 lm
Energieeffizienzklasse A+
Energy Efficiency Class A+
dimmbar, dimmable
Strahler 180° drehbar
spotlight 180° rotatable
Glas satiniert weiß
glass satin white

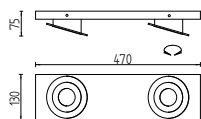

91.333.05 mattnickel, nickel dull

8 W LED
2.700 K, 800 lm
Energieeffizienzklasse A+
Energy Efficiency Class A+
dimmbar, dimmable
Strahler 180° drehbar
spotlight 180° rotatable
Glas satiniert weiß
glass satin white

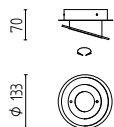



91.308.03 Messing matt, brass dull

91.308.05 mattnickel, nickel dull

19W LED, ca. 2.700 Lumen

2.900 K (Warmton, warm white)

Energieeffizienzklasse A++
Energy Efficiency Class A++

Glas weiß satiniert
glass white satin

dimmbar, dimmable

91.305.03 Messing matt, brass dull

91.305.05 mattnickel, nickel dull

1 x R 7 S (118 mm)
max. 230W ECO

Glas weiß satiniert
glass white satin

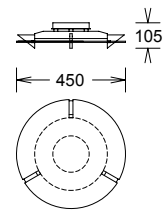

91.308.05 LED

Deckenleuchten · ceiling lamps

91.309.03 Messing matt, brass dull

91.309.05 mattnickel, nickel dull

19 W LED, ca. 2.700 lm
2.900 K (Warmton, warm white)

Energieeffizienzklasse A++
Energy Efficiency Class A++

Glas weiß satiniert
glass white satin

dimmbar, dimmable

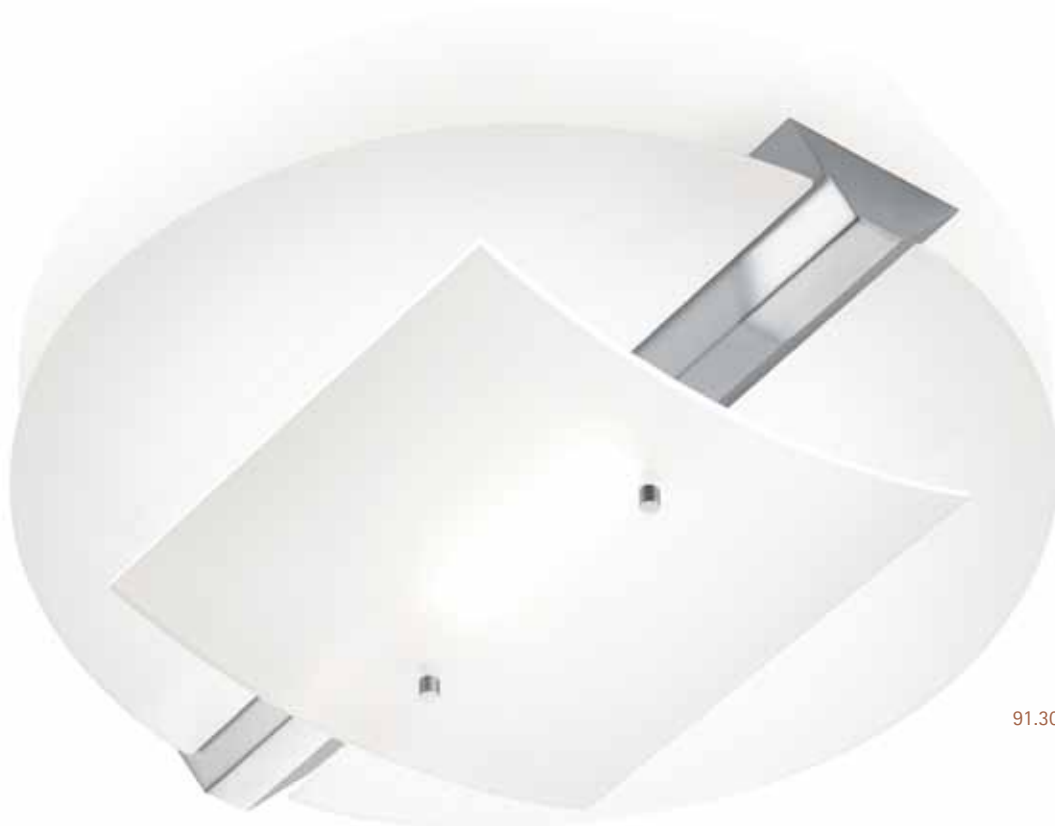
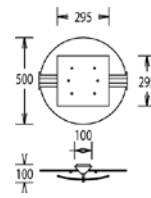

91.309.05 LED

91.307.05 mattnickel, nickel dull

19 W LED, ca. 2.700 lm
2.900 K (Warmton, warm white)

Energieeffizienzklasse A++
Energy Efficiency Class A++

Glas weiß satiniert
glass white satin

dimmbar, dimmable

91.277.03 Messing matt, brass dull

91.277.05 mattnickel, nickel dull

1 x R 7 S (118 mm)
max. 120 W ECO incl.

Glas weiß satiniert
glass white satin

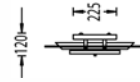
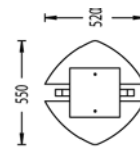

91.307.05 LED

Deckenleuchten · ceiling lamps



91.110.05

91.110.01 Messing poliert,
brass polished

91.110.05 mattnickel, nickel dull

91.110.06 Chrom, chrome

1 x E 27 max. 57W Halogen Classic ECO
Glas opal matt weiß, mit Bajonettverschluss
glass opal dull white, with bayonet catch



91.120.01

91.120.01 Messing poliert,
brass polished

91.120.05 mattnickel, nickel dull

91.120.06 Chrom, chrome

2 x E 27 max. 57W Halogen Classic ECO
Glas opal matt weiß, mit Bajonettverschluss
glass opal dull white, with bayonet catch

91.326.01 Messing poliert,
brass polished

91.326.05 mattnickel, nickel dull

91.326.06 Chrom, chrome

16 W LED, ca. 1.590 Lumen
2.700 K (Warmton, warm white)

Energieeffizienzklasse A+
Energy Efficiency Class A+

Glas opal matt weiß, mit Bajonettverschluss
glass opal dull white, with bayonet catch
dimbar, dimmable

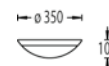

91.332.19 mattnickel / Chrom
nickel dull / chrome

2 x 16 W LED, je 1.590 lm
2.700 K (Warmton, warm white)

Energieeffizienzklasse A+
Energy Efficiency Class A+

Glas opal matt weiß
glass opal dull white
dimmbar, dimmable

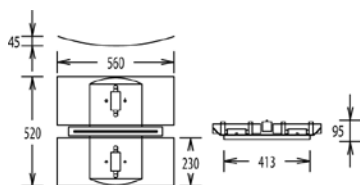

91.289.19 mattnickel / Chrom
nickel dull / chrome

91.289.30 Messing matt / poliert
brass dull / polished

2 x R 7 S (78 mm)
max. je 120W ECO incl.

Glas opal matt weiß
glass opal dull white



91.332.19 LED

91.327.03 Messing matt, brass dull

91.327.05 mattenickel, nickel dull

1 x 16 W LED, 1.590 lm
2.700 K (Warmton, warm white)

Energieeffizienzklasse A+
Energy Efficiency Class A+

dimbar
dimmable

Glas opal matt weiß
glas opal dull white

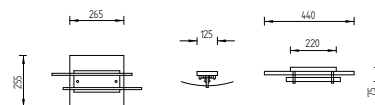

91.327.05 LED

91.280.03 Messing matt, brass dull

91.280.05 mattenickel, nickel dull

91.280.06 Chrom, chrome

1 x R 7 S (118 mm)
max. 120W ECO incl.

Glas satiniert
glass satin

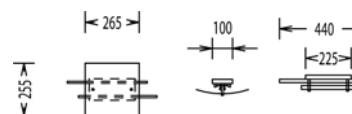

91.310.03 Messing matt, brass dull

91.310.05 mattnickel, nickel dull

1 x 16 W LED, 1.590 lm
2.700 K (Warmton, warm white)

Energieeffizienzklasse A+
Energy Efficiency Class A+

dimmbar, dimmable

2 x Halopin G9 230V
max. je 48W ECO incl.

2 x Glas Bleikristall satiniert weiß
und 1x Glas satiniert
2 x crystal glass satin white and
1 x glass satin

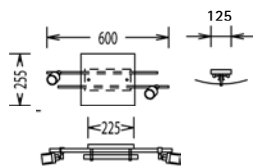

91.281.03 Messing matt, brass dull

91.281.05 mattnickel, nickel dull

91.281.06 Chrom, chrome

1 x R 7 S (118 mm)
max. 120W ECO incl.

2 x Halopin G9 230V
max. je 48W ECO incl.

2 x Glas Bleikristall satiniert weiß
und 1x Glas satiniert
2 x crystal glass satin white and
1 x glass satin

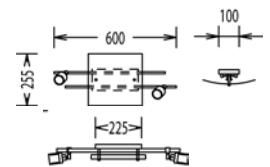

91.310.03 LED

Deckenleuchten · ceiling lamps

91.311.03

Messing matt, brass dull

91.311.05

mattnickel, nickel dull

1 x 16 W LED, 1.590 lm
2.700 K (Warmton, warm white)

Energieeffizienzklasse A+
Energy Efficiency Class A+

dimmbar, dimmable

4 x Halopin G9 230V
max. je 48W ECO incl.

4 x Glas Bleikristall satiniert weiß
und 1x Glas satiniert
4 x crystal glass satin white and
1 x glass satin

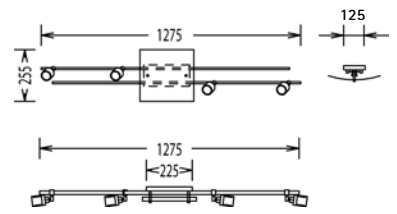

91.284.03 Messing matt, brass dull

91.284.05 mattnickel, nickel dull

91.284.06 Chrom, chrome

4 x Halopin G9 230V
max. je 48W ECO incl.

und 1 x R 7 S (118 mm)
max. 120W ECO incl.

4 x Glas Bleikristall satiniert weiß
und 1 x Glas satiniert

4 x crystal glass satin white and
1x glass satin

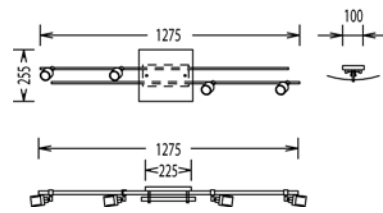

91.311.05 LED

21.820.03 Messing matt, brass dull

21.820.05 mattnickel, nickel dull

1 x 4,5W LED, ca. 470 Lumen
 2.900 K (Warmton, warm white)
 Energieeffizienzklasse A+
 Energy Efficiency Class A+
 Glas Bleikristall satiniert weiß
 crystal glass satin white



21.820.05 LED

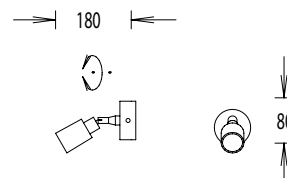

21.821.03 Messing matt, brass dull

21.821.05 mattnickel, nickel dull

2 x 4,5W LED, ca. 940 Lumen
 2.900 K (Warmton, warm white)
 Energieeffizienzklasse A+
 Energy Efficiency Class A+
 Glas Bleikristall satiniert weiß
 crystal glass satin white



21.821.03 LED

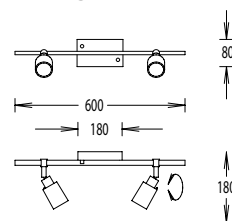

91.325.03 Messing matt, brass dull

91.325.05 mattnickel, nickel dull

91.325.06 Chrom, chrome

3 x 4,5W LED, ca. 1.410 Lumen
2.900 K (Warmton, warm white)

Energieeffizienzklasse A+
Energy Efficiency Class A+

Glas Bleikristall satiniert weiß

crystal glass satin white

dimmbar, dimmable

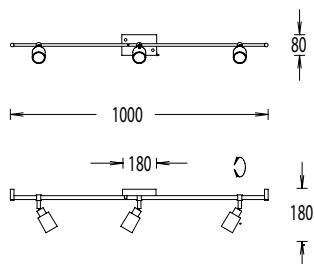

91.325.06 LED

91.324.03 Messing matt, brass dull

91.324.05 mattnickel, nickel dull

4 x 4,5W LED, ca. 1.880 Lumen
2.900 K (Warmton, warm white)

Energieeffizienzklasse A+
Energy Efficiency Class A+

Glas Bleikristall satiniert weiß

crystal glass satin white

dimmbar, dimmable

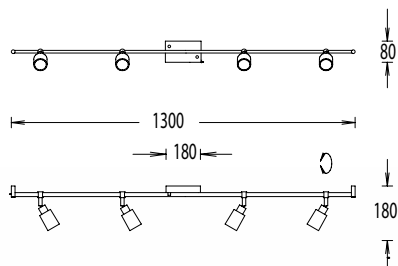

91.324.05 LED

21.757.03 Messing matt, brass dull

21.757.05 mattnickel, nickel dull

21.757.06 Chrom, chrome



21.757.03

Glas Bleikristall satiniert weiß
crystal glass satin white
mit Schalter, with switch

1 x Halopin G9 230V
max. 48W ECO incl.

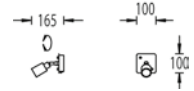

21.758.03 Messing matt, brass dull

21.758.05 mattnickel, nickel dull

21.758.06 Chrom, chrome



21.758.06

Glas Bleikristall satiniert weiß
crystal glass satin white

2 x Halopin G9 230V
max. je 48W ECO incl.

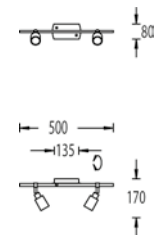

91.267.03 Messing matt, brass dull

91.267.05 mattnickel, nickel dull

91.267.06 Chrom, chrome

Glas Bleikristall satiniert weiß
crystal glass satin white

3 x Halopin G9 230V
max. je 48W ECO incl.

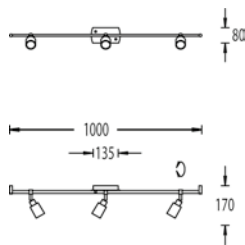

91.267.05

91.268.03 Messing matt, brass dull

91.268.05 mattnickel, nickel dull

Glas Bleikristall satiniert weiß
crystal glass satin white

4 x Halopin G9 230V
max. je 48W ECO incl.

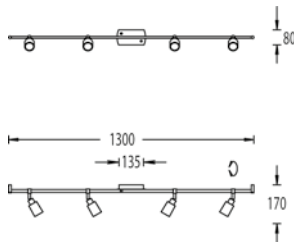

91.268.05

Deckenleuchten · ceiling lamps

91.269.03 Messing matt, brass dull

91.270.03 Messing matt, brass dull

91.269.05 mattnickel, nickel dull

91.270.05 mattnickel, nickel dull

Glas Bleikristall satiniert weiß
crystal glass satin white
3 x Halopin G9 230V
max. je 48W ECO incl.

Glas Bleikristall satiniert weiß
crystal glass satin white
4 x Halopin G9 230V
max. je 48W ECO incl.

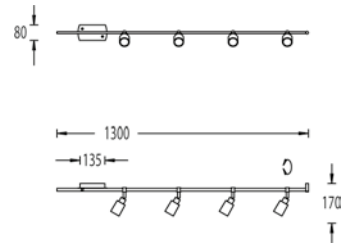
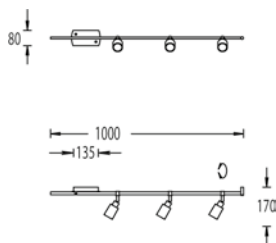

91.301.03 Messing matt, brass dull

91.301.05 mattnickel, nickel dull

Glas Bleikristall satiniert weiß
crystal glass satin white

2 x 2 Halopin G9 230V
max. je 48W ECO incl.

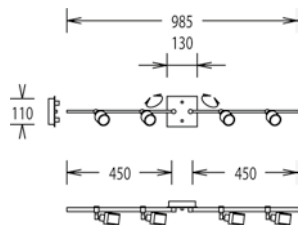

91.299.03 Messing matt, brass dull

91.299.05 mattnickel, nickel dull

Glas Bleikristall satiniert weiß
crystal glass satin white

2 + 3 Halopin G9 230V
max. je 48W ECO incl.

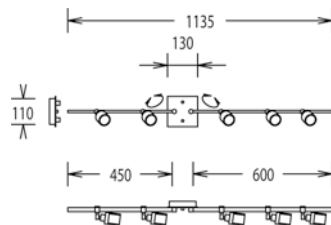

91.301.05

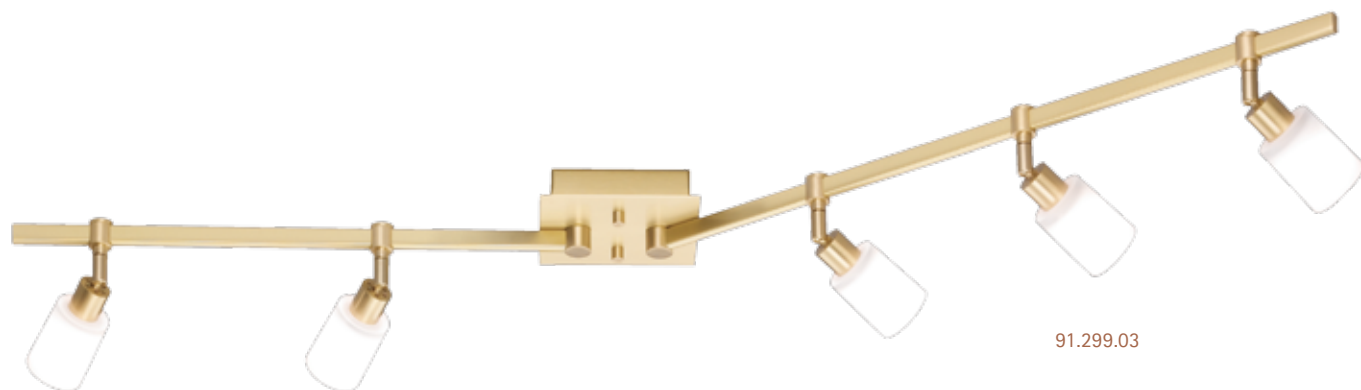

91.299.03

Deckenleuchten · ceiling lamps

91.271.03 Messing matt, brass dull

91.271.05 mattnickel, nickel dull

Glas Bleikristall satiniert weiß
crystal glass satin white

2 x 3 Halopin G9 230V
max. je 48W ECO incl.

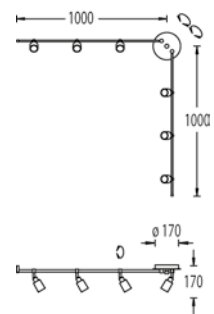

91.271.05









Unsere Pendelleuchten lassen sich stufenlos höhenverstellen. Ausgestattet mit moderner energiesparender LED-Technik. Hochwertige Materialien und gute Verarbeitung gewährleisten eine zuverlässige Funktionalität und lange Lebensdauer. Hitzebeständige Gläser und galvanisch veredelte Oberflächen zeichnen unsere Produkte aus. Made in Germany

51.473.05 mattnickel, nickel dull

4 x 7 W LED, ca. 4.200 Lumen
2.900 K (Warmton, warm white)

Energieeffizienzklasse A++
Energy Efficiency Class A++
zentral dimmbar, dimmalbe

Glas schwarz / klar
glass black / clear

höhenverstellbar
height variable adjustable

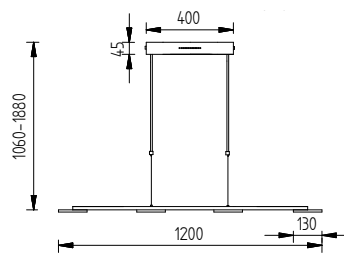



51.471.03 Messing matt, brass dull

51.471.05 mattnickel, nickel dull

51.471.06 Chrom, chrome

18,5 W LED-Stripe , ca. 1.500 Lumen
2.700 K (Warmton, warm white)

Energieeffizienzklasse A
Energy Efficiency Class A

zentral dimmbar , dimmable

Glas satiniert/Rand klar
glass satin /border clear

höhenverstellbar
height variable adjustable

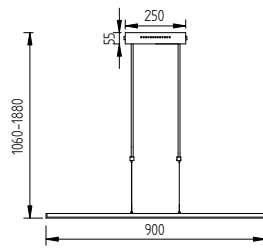

51.471.03 LED

Pendelleuchten · pendants lamps

51.470.03 Messing matt, brass dull

51.470.05 mattnickel, nickel dull

51.470.06 Chrom, chrome

29 W LED-Stripe , ca. 2.200 Lumen
2.700 K (Warmton, warm white)

Energieeffizienzklasse A
Energy Efficiency Class A

zentral dimmbar, dimmable

Glas satiniert/Rand klar
glass satin /border clear

höhenverstellbar
height variable adjustable

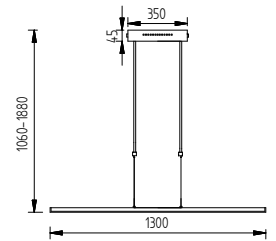

51.470.05 LED





Pendelleuchten · pendants lamps

51.472.05 mattnickel, nickel dull

31 W LED-Stripe, ca. 2.400 Lumen
2.700 K (Warmton, warm white)

Energieeffizienzklasse A
Energy Efficiency Class A

zentral dimmbar, dimmable

höhenverstellbar
height variable adjustable

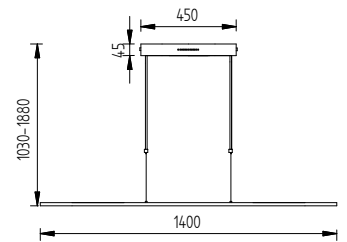

51.472.05 LED

51.466.05 mattnickel, nickel dull

24 W LED-Stripe , ca. 1.900 Lumen
2.700 K (Warmton, warm white)

Energieeffizienzklasse A
Energy Efficiency Class A

zentral dimmbar, dimmable

höhenstellbar
height adjustable

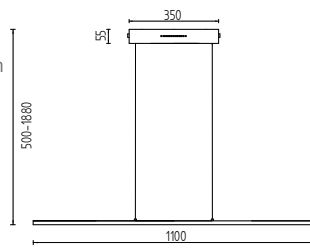

51.467.05 mattnickel, nickel dull

31 W LED-Stripe , ca. 2.400 Lumen
2.700 K (Warmton, warm white)

Energieeffizienzklasse A
Energy Efficiency Class A

zentral dimmbar, dimmable

höhenstellbar
height adjustable

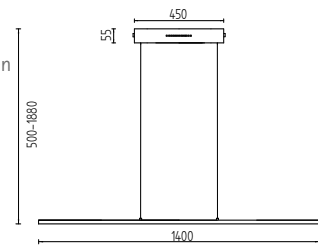

51.467.05 LED

Pendelleuchten · pendants lamps



51.464.05 mattnickel, nickel dull

24 W LED-Stripe , ca. 1.900 Lumen
2.700 K (Warmton, warm white)

Energieeffizienzklasse A
Energy Efficiency Class A

zentral dimmbar, dimmable

höhenverstellbar
height variable adjustable



51.464.05 LED

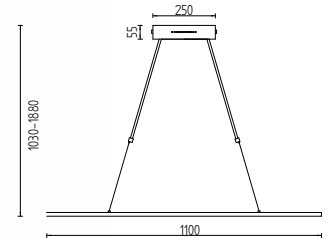

51.465.05 mattnickel, nickel dull

31 W LED-Stripe , ca. 2.400 Lumen
2.700 K (Warmton, warm white)

Energieeffizienzklasse A
Energy Efficiency Class A

zentral dimmbar, dimmable

höhenverstellbar
height variable adjustable

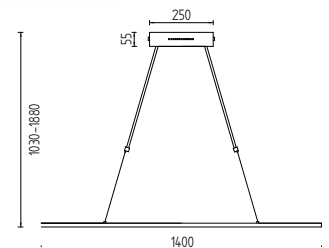

51.468.05 mattnickel, nickel dull

24 W LED-Stripe , ca. 1.900 Lumen
2.700 K (Warmton, warm white)

Energieeffizienzklasse A
Energy Efficiency Class A

zentral dimmbar, dimmable

höhenverstellbar
height variable adjustable

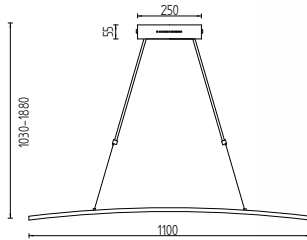

51.468.05 LED

51.469.05 mattnickel, nickel dull

31 W LED-Stripe , ca. 2.400 Lumen
2.700 K (Warmton, warm white)

Energieeffizienzklasse A
Energy Efficiency Class A

zentral dimmbar, dimmable

höhenverstellbar
height variable adjustable

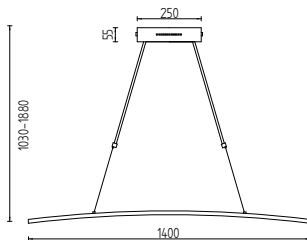

Pendelleuchten · pendants lamps

51.451.05 mattnickel, nickel dull

51.451.06 Chrom, chrome

8 x 3 W LED, ca. 2.880 Lumen
2.700 K (Warmton, warm white)

Energieeffizienzklasse A+
Energy Efficiency Class A+

zentral dimmbar, dimmable

Glas satiniert/Rand klar
glass satin /border clear

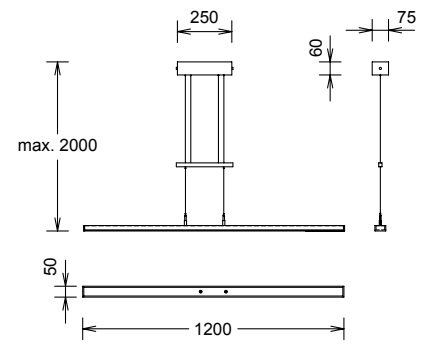





51.457.05 mattnickel, nickel dull

51.457.06 Chrom, chrome

8 x 3 W LED, ca. 2.920 Lumen
3.000 K (Warmton, warm white)
Energieeffizienzklasse A+
Energy Efficiency Class A+
zentral dimmbar, dimmable
Glas klar /Rand satiniert
glass clear/border satin

51.457.05-27 mattnickel, nickel dull

51.457.06-27 Chrom, chrome

8 x 3 W LED, ca. 2.880 Lumen
2.700 K (Warmton, warm white)
Energieeffizienzklasse A+
Energy Efficiency Class A+
zentral dimmbar, dimmable
Glas klar /Rand satiniert
glass clear/border satin

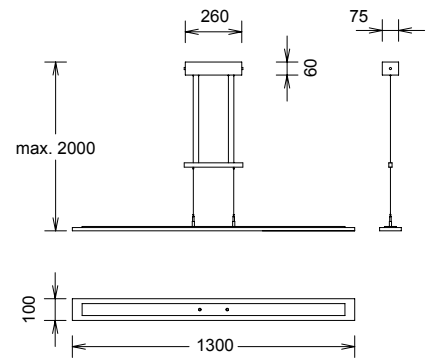

51.457.05 LED

51.458.05 mattnickel, nickel dull

51.458.06 Chrom, chrome

6 x 3 W LED, ca. 2.190 Lumen
3.000 K (Warmton, warm white)
Energieeffizienzklasse A+
Energy Efficiency Class A+
zentral dimmbar, dimmable
Glas klar /Rand satiniert
glass clear /border satin

51.458.05-27 mattnickel, nickel dull

51.458.06-27 Chrom, chrome

6 x 3 W LED, ca. 2.160 Lumen
2.700 K (Warmton, warm white)
Energieeffizienzklasse A+
Energy Efficiency Class A+
zentral dimmbar, dimmable
Glas klar /Rand satiniert
glass clear /border satin

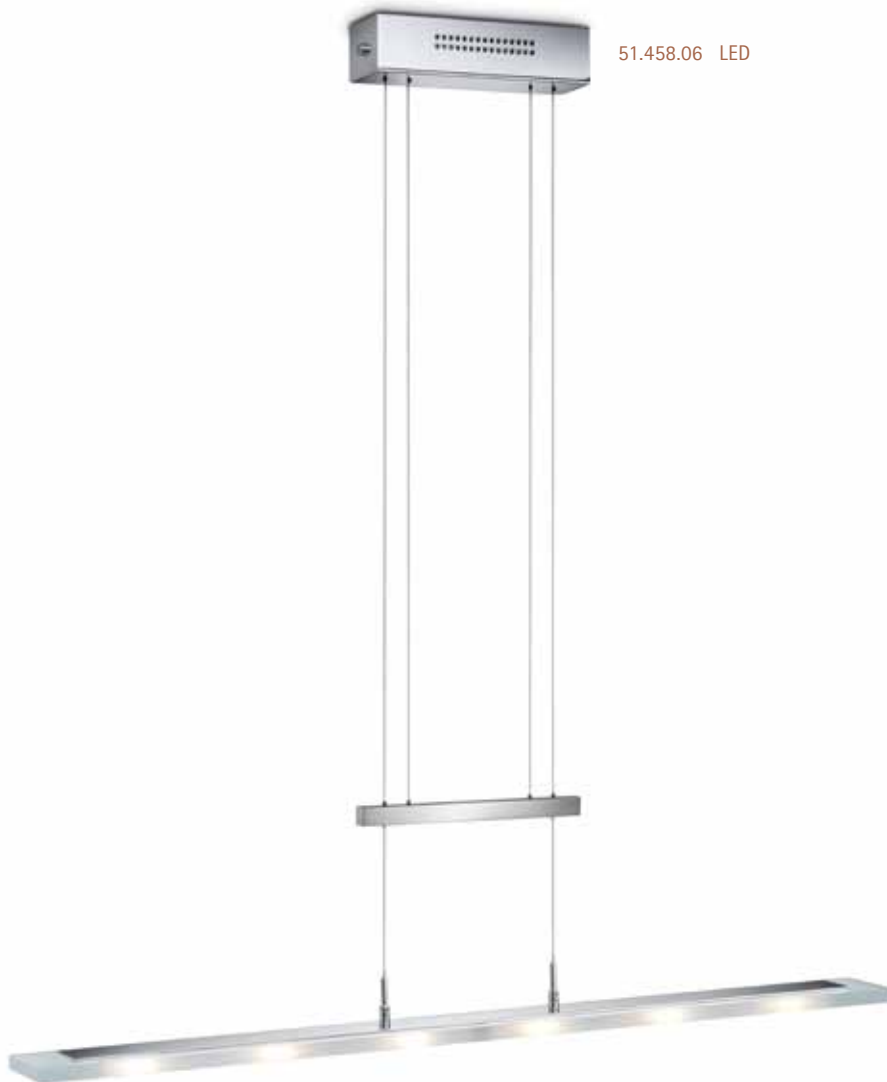
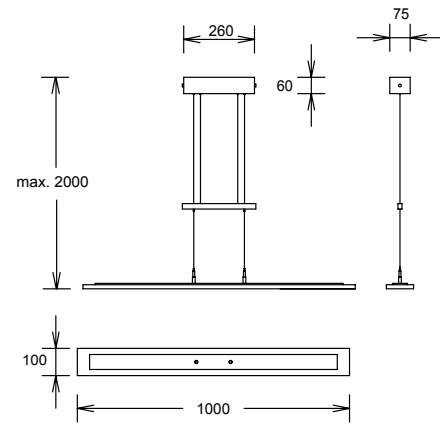

51.458.06 LED

51.459.05 mattnickel, nickel dull

51.459.06 Chrom, chrome

5 x 3 W LED, ca. 1.825 Lumen
3.000 K (Warmton, warm white)
Energieeffizienzklasse A+
Energy Efficiency Class A+
zentral dimmbar, dimmable
Glas klar /Rand satiniert
glass clear/border satin

51.459.05-27 mattnickel, nickel dull

51.459.06-27 Chrom, chrome

5 x 3 W LED, ca. 1.805 Lumen
2.700 K (Warmton, warm white)
Energieeffizienzklasse A+
Energy Efficiency Class A+
zentral dimmbar, dimmable
Glas klar /Rand satiniert
glass clear/border satin

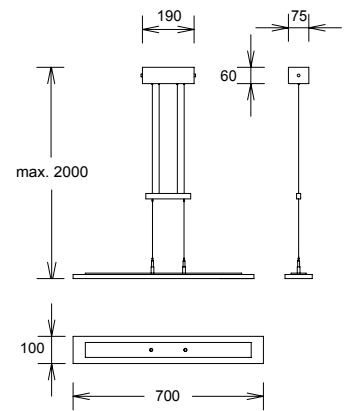

Pendelleuchten · *pendants lamps*

51.294.01 Messing poliert/Plexiglas
brass polished/acrylic glass
Schirm, shade
Silkolite schneeweiß, snow
25/52/25 cm

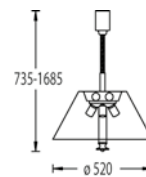

3 x E 27 max. je 77W Halogen Classic ECO
+ Deckenstrahler, ceiling spot
2 x E 27 max. je 46W Halogen Classic ECO
getrennt schaltbar mit Zugschalter
separate switchable with pullswitch



51.294.01

51.193.03 Messing matt, brass dull
Schirm, shade
Silkana rohweiß, raw white
25/52/25 cm

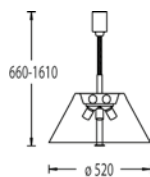

51.193.04 bronze, bronze
Schirm, shade
Silkana crème
25/52/25 cm

51.193.05 mattsilber, silver dull
Schirm, shade
Chintz weiß, white
25/52/25 cm

3 x E 27 max. je 77W Halogen Classic ECO
+ Deckenstrahler, ceiling spot

2 x E 27 max. je 46W Halogen Classic ECO

getrennt schaltbar mit Zugschalter
separate switchable with pullswitch



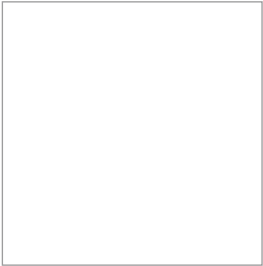

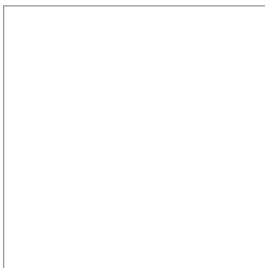
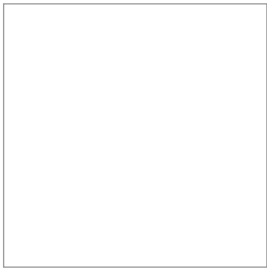



21.819.05 mattnickel, nickel dull

21.819.06 Chrom, chrome

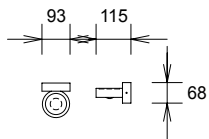

2 x 4,5 W LED, ca. 940 Lumen
2.900 K, (Warmton, warm white)

Energieeffizienzklasse A+
Energy Efficiency Class A+

nicht dimmbar
not dimmable

Oberseite Reflektor:
Metallfilter mit Schlitz
metal filter with slots
on top of reflector

Zubehör, accessoires:
Artikel-Nr. 95.006
Glasfilter weiss satiniert
glass filter white satin

Wandleuchten · wall lamps

21.830.05 + .. mattnickel, nickel dull
ohne Abdeckung, without cover

21.830.06 + .. Chrom, chrome
ohne Abdeckung, without cover

21.830.08 + .. weiß matt, white
ohne Abdeckung, without cover

2 x 4 W LED
2.700 K, 2 x 400 lm
Energieeffizienzklasse A+
Energy Efficiency Class A+

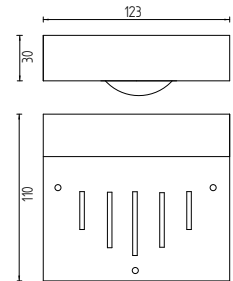



21.830.08 Leuchte weiß, lamp white +
 G21.830 Glas oben, glass top +
 F 21.830.08-3 Glas Linse unten, glass lense bottom



21.830.06 Leuchte mattnickel, nickel dull +
 F 21.830.05-2 Streifen oben, stripes top +
 F 21.830.05-3 Glas Linse unten, glass lense bottom

Jede Leuchte benötigt zusätzlich 2 Abdeckungen (1 x oben und 1 x unten). Die Abdeckungen sind nach Wunsch kombinierbar
 All lamps need 2 additional covers / filters (1 x on top and 1 x on botton). The covers are optional combinable

Folgende Lichtbilder werden erzeugt:
 the following lighting effects can be generated:

Streifen, stripes



F21.830.05-2 mattnickel, nickel dull
 F21.830.06-2 Chrom, chrome
 F21.830.08-2 weiß, white

Glas Linse, glass lense



F21.830.05-3 mattnickel, nickel dull
 F21.830.06-3 Chrom, chrome
 F21.830.08-3 weiß, white

Glas, glass

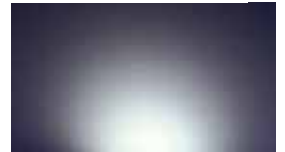

G21.830



21.829.05 mattnickel, nickel dull

12 W LED, ca. 1.210 lm
2.700 K (Warmton, warm white)

Energieeffizienzklasse A+
Energy Efficiency Class A+

Glas klar/Rand satiniert
glass clear/border satin

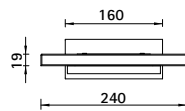
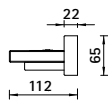

21.794.03 Messing matt, brass dull

21.794.05 mattnickel, nickel dull

1 x Halopin G9 230V
max. 60W ECO incl.

Glas klar/Rand satiniert
glass clear/border satin

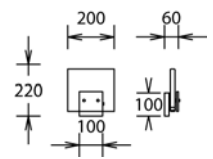

21.829.05 LED



21.794.05

Wandleuchten · wall lamps

21.804.05 mattnickel, nickel dull

21.804.06 Chrom, chrome

1 x 3 W LED, ca. 365 Lumen
3.000 K (Warmton, warm white)
Energieeffizienzklasse A+
Energy Efficiency Class A+
mit Schalter
with switch

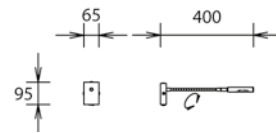

21.804.06 LED

21.769.02 Messing poliert/matt
brass polished/dull



21.769.03 Messing matt, brass dull

21.769.05 mattnickel, nickel dull

1 x Halopin G9 230V
max. 48W ECO incl.

mit Schalter, with switch

Glas Bleikristall satiniert weiß
crystal glass satin white



21.769.05



21.769.03

Wandleuchten · wall lamps

21.738.05 mattnickel, nickel dull

21.738.06 Chrom, chrome

2 x Halopin G9 230V
max. je 48W ECO incl.

Glas satiniert weiß
glass satin white

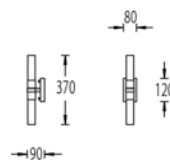

21.738.06



21.738.06

21.825.05 mattnickel, nickel dull

Schirm, shade
Chintz weiß, white
28x13/19 cm

1 x E 27 max. 57W Halogen Classic ECO

Flexschlauch: 1 x 2,6 W LED, ca. 150 Lumen
2900 K (Warmton, warm white)

Energieeffizienzklasse A+
Energy Efficiency Class A+

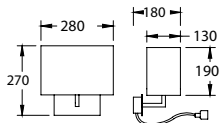

21.825.05

21.824.05 mattnickel, nickel dull

Schirm, shade
Chintz weiß, white
28x13/19 cm

1 x E 27 max. 57W Halogen Classic ECO

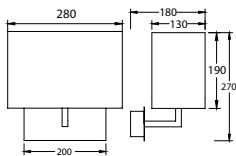

21.824.05

Wandleuchten · wall lamps

21.823.05 mattnickel, nickel dull

Schirm, shade

Chintz weiß, white

28x13/19 cm

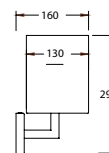
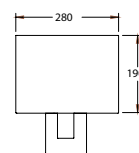

1 x E 27 max. 57W Halogen Classic ECO



21.823.05

21.826.02 Messing poliert/matt
brass polished/dull
Schirm, shade
Honan ecrü, ecru
10/28/18 cm

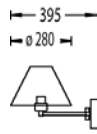

21.826.05 mattenickel, nickel dull
Schirm, shade
Honan weiß, white
10/28/18 cm

1 x E 27 max. 57W Halogen Classic ECO



Wandleuchten · wall lamps

21.827.02 Messing poliert/matt
brass polished/dull
Schirm, shade
Silkolite weiß, white
10/28/18 cm

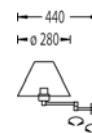

21.827.05 mattnickel, nickel dull
Schirm, shade
Silkolite schneeweiß, snow
10/28/18 cm

1 x E 27 max. 57W Halogen Classic ECO



21.827.02

21.828.02 Messing poliert/matt
brass polished/dull
Schirm, shade
Silkolite weiß, white
10/26/17 cm

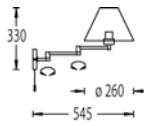

21.828.05 mattnickel, nickel dull
Schirm, shade
Silkolite schneeweiß, snow
10/26/17 cm

1 x E 27 max. 57W Halogen Classic ECO



21.828.02

Wandleuchten · wall lamps

21.816.03 Messing matt, brass dull

21.816.05 mattnickel, nickel dull

2 x 4,5W LED, ca. 940 Lumen
2.900 K (Warmton, warm white)

Energieeffizienzklasse A+
Energy Efficiency Class A+

mit Tastdimmer
with touch dimmer

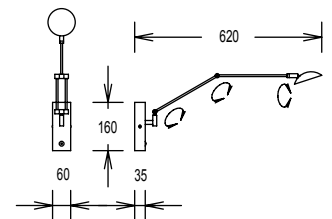

21.816.05 LED

21.751.02 Messing poliert/matt
brass polished/dull

21.751.03 Messing matt, brass dull

21.751.05 mattnickel, nickel dull



1 x GY 6,35 12V, 50W incl.
mit Drehdimmer
with rotary dimmer



21.751.02

21.770.02 Messing poliert/matt
brass polished/dull

21.770.03 Messing matt, brass dull

21.770.05 mattnickel, nickel dull

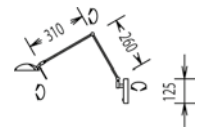

1 x Halopin G9 230V
max. 48W ECO incl.
mit Tastdimmer
with touch dimmer

Glas opal matt weiß
glass opal dull white
z.B. 21.770.xx -1

Glas opal matt amber
glass opal dull amber
z.B. 21.770.xx -3



21.770.05

Wandleuchten · wall lamps

21.814.03 Messing matt, brass dull

21.814.05 mattnickel, nickel dull

21.814.06 Chrom, chrome

1 x GY 6,35 12V, 50W
Halostar ECO incl.

mit Drehdimmer
with rotary dimmer

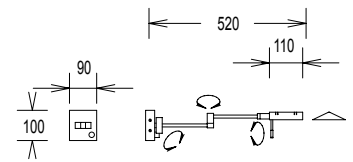

21.814.06

21.813.03 Messing matt, brass dull

21.813.05 mattenickel, nickel dull

21.813.06 Chrom, chrome

1 x GY 6,35 12V, 50W
Halostar ECO incl.

mit Dimmer in Zuleitung
with dimmer in conducting cable

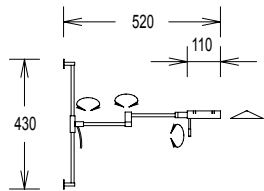



21.831.05 mattnickel, nickel dull

6,5 W LED-Stripe, ca. 450 Lumen
2.700 K (Warmton, warm white)

Energieeffizienzklasse A
Energy Efficiency Class A

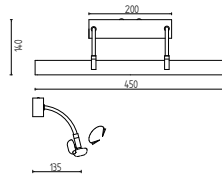

21.832.05 mattnickel, nickel dull

9 W LED-Stripe, ca. 600 Lumen
2.700 K (Warmton, warm white)

Energieeffizienzklasse A
Energy Efficiency Class A

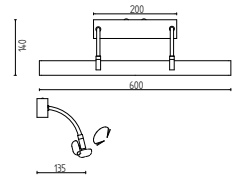

21.831.05 LED



21.797.01 Messing poliert, brass polished

21.797.03 Messing matt, brass dull

21.797.05 mattnickel, nickel dull

2 x 3 W LED, ca. 730 Lumen
2.900 K (Warmton, warm white)

Energieeffizienzklasse A+
Energy Efficiency Class A+

mit Schalter, with switch

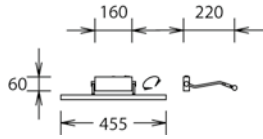

21.798.01 Messing poliert, brass polished

21.798.03 Messing matt, brass dull

21.798.05 mattnickel, nickel dull

1 x 3 W LED, ca. 365 Lumen
2.900 K (Warmton, warm white)

Energieeffizienzklasse A++
Energy Efficiency Class A++

mit Schalter, with switch

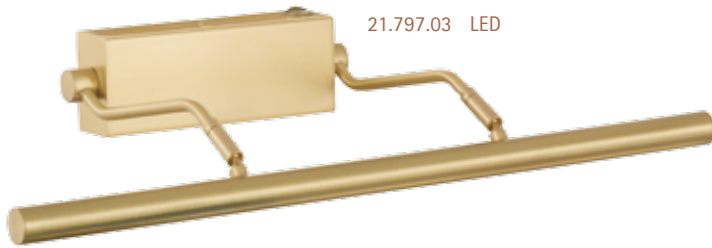
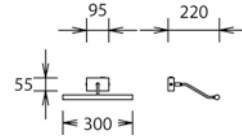

21.797.03 LED



21.798.05 LED

21.572.02 Messing poliert/matt
brass polished/dull

1 x FM (T2) 8 Watt W 4,3 incl.
mit Schalter, with switch

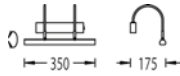

21.573.02 Messing poliert/matt
brass polished/dull

1 x FM (T2) 11 Watt W 4,3 incl.
mit Schalter, with switch

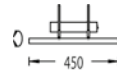

21.574.02 Messing poliert/matt
brass polished/dull

1 x FM (T2) 13 Watt W 4,3 incl.
mit Schalter, with switch

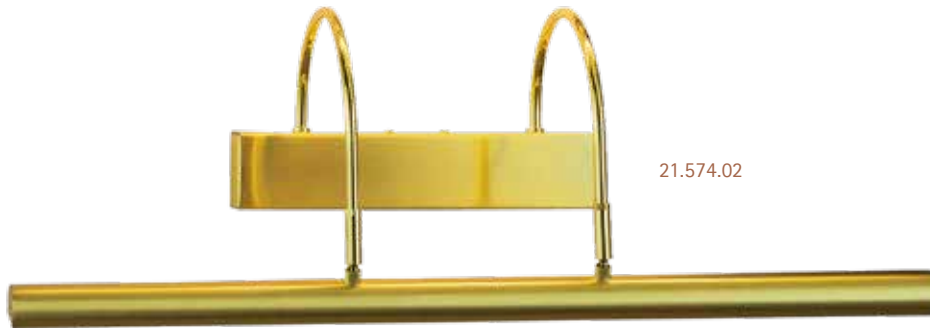
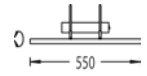

21.294.01 Messing poliert
brass polished

21.294.03 Messing matt, brass dull

21.294.04 bronze, bronze

21.294.05 mattnickel, nickel dull

4 x E 14 max. je 25W
Special Birnenform T/FRIDGE

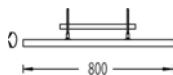

21.316.01 Messing poliert
brass polished

21.316.03 Messing matt, brass dull

21.316.04 bronze, bronze

21.316.05 mattnickel, nickel dull

21.316.06 Chrom, chrome

2 x E 14 max. je 25W
Special Birnenform T/FRIDGE

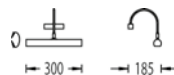

21.318.01 Messing poliert
brass polished

21.318.03 Messing matt, brass dull

21.318.04 bronze, bronze

21.318.05 mattnickel, nickel dull

21.318.06 Chrom, chrome

2 x E 14 max. je 25W
Special Birnenform T/FRIDGE



21.294.03



21.316.03



21.318.06

95.005.03 Messing matt, brass dull

95.005.05 mattnickel, nickel dull

95.005.20 Chrom matt/chrome dull

Anschlussdose, junction box

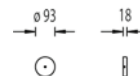

95.005.03

95.001.03 50 cm, Messing matt
brass dull

95.001.05/20 50 cm, Edelstahl
refined steel

95.002.03 100 cm, Messing matt
brass dull

95.002.05/20 100 cm, Edelstahl
refined steel

95.003.03 150 cm, Messing matt
brass dull

95.003.05/20 150 cm, Edelstahl
refined steel

95.004.05/20 200 cm, Edelstahl
refined steel



95.002.05/20

Spirale mit Kabel
spiral spring with cable

CASAMBI

Casambi betriebene Leuchten können direkt vom Lichtschalter gedimmt werden:
Casambi emmedded lights are dimmable directly from the wall switch:

- Ohne zusätzliche Installation eines Dimmers
without an installation of an additional dimmer
- Einfach Leuchte montieren und den bestehenden Schalter als Dimmer nutzen
Just plug in the lamp and use the wall switch as new dimmer

Dimmung über den Schalter dimming process by switch

1. Einmal schnell Aus / An schalten startet den Dimmvorgang
Flick* the switch once to start dimming process
2. Erneut schnell Aus / An schalten legt den Dimmlevel fest
Flick the switch again to save the current brightness level as new default
3. Der gewünschte Dimmlevel ist nun als Standard gespeichert
The adjusted brightness level is set as the new default setting of the lamp
4. Ein Einschalten der Leuchte hat nun diesen Dimmlevel

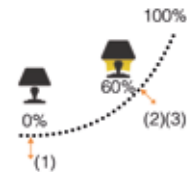
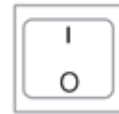

- Um den gespeicherten Dimmlevel wieder zu ändern, einfach den Dimmvorgang komplett ab 1 wiederholen
to change the adjusted brightness level start dimming process from beginning
- Um 100 % Lichtleistung zu haben, einmal schnell Aus / An schalten und Dimmvorgang nicht unterbrechen
To set default brightnss level back to 100 %, flick switch only once. After dimming process reach 100%





Leuchten per App Steuern: *

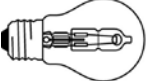

Control your lamps via your smartphone *

1. Gratis Casambi App aus dem App Store downloaden und installieren
download and install Casambi App from App Store
2. Schalten Sie die Casambi betriebenen Leuchten ein und starten Sie die App
open Casambi App when all your Casambi embedded lamps are switch on
3. Leuchte mit einem Klick zu Netzwerk hinzufügen
one click adds all your lamps to a new network.
4. Sofort los legen! Leuchten über Smartphone und Tablet schalten
That's it! Control all your lamps with your smartphone or tablet

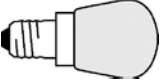
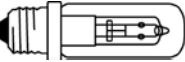
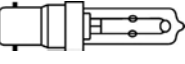
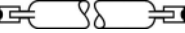

Leuchtmittelübersicht und Energiekettierung · lamp overview and energy labeling

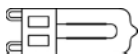
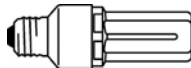
	Produktbezeichnung product-indication	Socket socket	Leistung in Watt output power	Lichtstrom luminous flux (lm)	Energieeffizienz- klasse / energy efficiency class	Mittlere Lebens- dauer / average life (h)
	Halogen Eco Pro Classic A	E 27	20	235	C	2.000
		E 27	30	405	C	2.000
		E 27	46	700	C	2.000
		E 27	57	915	C	2.000
		E 27	77	1320	C	2.000
	Halogen Eco Pro Classic B	E 14	20	235	C	2.000
		E 14	30	405	C	2.000
		E 14	46	700	C	2.000
	Special Birnenform T / Fridge	E 14	15	110	E	1.000
		E 14	25	190	F	1.000
	Halolux CERAM Eco	E 27	70	1180	C	2.000
		E 27	100	1800	C	2.000
		E 27	150	2870	C	2.000
		E 27	205	4200	C	2.000
	Halolux CERAM Eco	B15d	40	590	C	2.000
		B15d	60	980	C	2.000
		B15d	70	1180	C	2.000
		B15d	100	1800	C	2.000
	Haloline Eco 78 mm	R7s	48	750	C	2.000
		R7s	80	1400	C	2.000
		R7s	120	2250	C	2.000
	Haloline Eco 118 mm	R7s	120	2250	C	2.000
		R7s	160	3100	C	2.000
		R7s	230	5000	C	2.000
		R7s	400	9000	C	2.000
	Halostar Standard	Gy6,35	35	600		2.000
		Gy6,35	50	910		2.000

	Produktbezeichnung product-indication	Socket socket	Leistung in Watt output power	Lichtstrom luminous flux (lm)	Energieeffizienz- klasse / energy efficiency class	Mittlere Lebens- dauer / average life (h)
	Halostar Eco	Gy6,35	25	500		4.000
		Gy6,35	35	860		4.000
		Gy6,35	50	1200		4.000
		Gy6,35	60	1650		4.000
	Halopin Eco	G9	20	235	C	2.000
		G9	33	460	C	2.000
		G9	48	740	C	2.000
		G9	60	980	C	2.000
	Dulux Intelligent DIM	E 27	18	1140	A	20.000
		E 27	20	1300	A	20.000
	Dulux Intelligent Longlife	E 27	7	380	A	20.000
		E 27	11	640	A	20.000
		E 27	14	820	A	20.000
		E 27	18	1140	A	20.000
	Lumilux T2 FM Stabform	W 4,3	8	540	B	8.000
		W 4,3	11	750	B	8.000
		W 4,3	13	930	B	8.000

Die Leuchtmittel Angaben beziehen sich auf OSRAM - Produkte Stand 2015

Artikel-Nr. · article-no.	Seite · page
Klemmleuchten · clamp lamps	
11.35.03	117
11.35.05	117
Wandleuchten · wall lamps	
21.294.01*	189
21.294.03*	189
21.294.04*	189
21.294.05*	189
21.316.01*	189
21.316.03*	189
21.316.04*	189
21.316.05*	189
21.316.06*	189
21.318.01*	189
21.318.03*	189
21.318.04*	189
21.318.05*	189
21.318.06*	189
21.572.02	188
21.573.02	188
21.574.02	188
21.738.05	174
21.738.06	174
21.751.02	181
21.751.03	181
21.751.05	181
21.757.03	138
21.757.05	138
21.757.06	138
21.758.03	138
21.758.05	138
21.758.06	138
21.769.02	173
21.769.03	173
21.769.05	173
21.770.02-1	181
21.770.02-3	181
21.770.03-1	181
21.770.03-3	181
21.770.05-1	181
21.770.05-3	181
21.794.03	171
21.794.05	171

Artikel-Nr. · article-no.	Seite · page
21.797.01	187
21.797.03	187
21.797.05	187
21.798.01	187
21.798.03	187
21.798.05	187
21.804.05	172
21.804.06	172
21.813.03	183
21.813.05	183
21.813.06	183
21.814.03	182
21.814.05	182
21.814.06	182
21.816.03	180
21.816.05	180
21.819.05	167
21.819.06	167
21.820.03	136
21.820.05	136
21.821.03	136
21.821.05	136
21.823.05*	176
21.824.05*	175
21.825.05*	175
21.826.02*	177
21.826.05*	177
21.827.02*	178
21.827.05*	178
21.828.02*	179
21.828.05*	179
21.829.05	171
21.830.05	168
21.830.06	168
21.830.08	168
21.831.05	185
21.832.05	185
Stehleuchten · floor lamps	
41.618.02*	43
41.618.04*	43
41.618.05*	43
41.687.01*	39
41.735.02*	42

Artikel-Nr. · article-no.	Seite · page
41.774.02*	67
41.774.03*	67
41.774.04*	67
41.774.05*	67
41.791.03	58
41.791.05	58
41.791.12	58
41.844.03*	39
41.844.05*	39
41.850.03*	38
41.850.05*	38
41.851.02	61
41.851.03	61
41.851.05	61
41.861.02	86
41.861.03	86
41.861.04	86
41.861.05	86
41.864.02*	41
41.864.03*	41
41.864.19*	41
41.871.02	60
41.871.03	60
41.871.05	60
41.878.03-1	59
41.878.03-3	59
41.878.05-1	59
41.878.05-3	59
41.878.06-1	59
41.878.06-3	59
41.881.03-1	83
41.881.05-1	83
41.882.03-1	82
41.882.05-1	82
41.883.03	87
41.883.05	87
41.884.02	85
41.884.03	85
41.884.05	85
41.888.02-1	29
41.888.02-3	29
41.888.03-1	29
41.888.03-3	29
41.888.05-1	29

Artikel-Nr. · article-no.	Seite · page
41.888.05-3	29
41.888.19-1	29
41.888.19-3	29
41.888.30-1	29
41.888.30-3	29
41.890.03-1	32
41.890.03-3	32
41.890.05-1	32
41.890.05-3	32
41.890.19-1	32
41.890.19-3	32
41.890.30-1	32
41.890.30-3	32
41.894.05*	33
41.902.02	66
41.902.03	66
41.902.05	66
41.902.06	66
41.903.23*	37
41.909.03*	88
41.909.05*	88
41.909.19*	88
41.910.03	89
41.910.05	89
41.910.19	89
41.912.03	40
41.912.05	40
41.913.03	61
41.913.05	61
41.916.03	52
41.916.05	52
41.916.06	52
41.919.03	65
41.919.05	65
41.919.06	65
41.922.03	63
41.922.05	63
41.922.06	63
41.923.03	64
41.923.05	64
41.923.06	64
41.924.03	57
41.924.05	57
41.924.06	57

Artikel-Nr. · article-no.	Seite · page
41.925.03-1	80
41.925.05-1	80
41.925.19-1	80
41.925.30-1	80
41.926.03-1	81
41.926.05-1	81
41.926.19-1	81
41.926.30-1	81
41.930.03	57
41.930.05	57
41.930.06	57
41.931.05	73
41.932.05	73
41.933.03-1	28
41.933.03-3	28
41.933.05-1	28
41.933.05-3	28
41.935.05	51
41.935.06	51
41.937.05	51
41.937.06	51
41.939.05	48
41.939.06	48
41.940.03	75
41.940.05	75
41.942.03	75
41.942.05	75
41.942.19	75
41.944.03	55
41.944.05	55
41.945.05	49
41.945.06	49
41.946.03	54
41.946.05	54
41.947.05*	33
41.948.05	35
41.948.06	35
41.949.03	62
41.949.05	62
41.950.05	26
41.951.03	53
41.951.05	53
41.952.03	27
41.952.05	27
41.953.03	30
41.953.05	30

Artikel-Nr. · article-no.	Seite · page
41.954.03	77
41.954.05	77
41.955.03	76
41.955.05	76
41.956.03	31
41.956.05	31
41.957.03	56
41.957.05	56
41.958.05	47
41.958.06	47
41.958.07	47
41.959.05	70
41.960.03	84
41.960.05	84
41.961.03	79
41.961.05	79
41.961.19	79
41.962.03	78
41.962.05	78
41.962.19	78

Pendelleuchten · pendant lamps

51.193.03*	163
51.193.04*	163
51.193.05*	163
51.294.01*	162
51.451.05	156
51.451.06	156
51.457.05	159
51.457.05-27	159
51.457.06	159
51.457.06-27	159
51.458.05	160
51.458.05-27	160
51.458.06	160
51.458.06-27	160
51.459.05	161
51.459.05-27	161
51.459.06	161
51.459.06-27	161
51.464.05	154
51.465.05	154
51.466.05	153
51.467.05	153
51.468.05	155
51.469.05	155

Artikel-Nr. · article-no.	Seite · page
51.470.03	150
51.470.05	150
51.470.06	150
51.471.03	149
51.471.05	149
51.471.06	149
51.472.05	152
51.473.05	147

Tischleuchten · table lamps

61.274.01*	115
61.471.01*	115
61.505.02	104
61.505.03	104
61.505.05	104
61.505.12	104
61.545.03	105
61.545.04	105
61.545.05	105
61.581.23*	111
61.585.23*	111
61.586.02	109
61.586.03	109
61.586.05	109
61.586.19	109
61.599.05	96
61.599.06	96
61.600.03	107
61.600.05	107
61.600.06	107
61.602.03	107
61.602.05	107
61.603.03	101
61.603.05	101
61.603.06	101
61.605.03	101
61.605.05	101
61.605.06	101
61.606.05*	110
61.608.05	99
61.608.06	99
61.610.05	99
61.610.06	99
61.611.05	95
61.611.06	95
61.612.03	108

Artikel-Nr. · article-no.	Seite · page
61.612.05	108
61.613.05*	113
61.614.05*	112
61.615.03	102
61.615.05	102
61.618.03	103
61.618.05	103
61.619.03	100
61.619.05	100
61.620.05	93
61.620.06	93
61.620.07	93
71.302.02*	114
71.302.03*	114
71.302.19*	114

Deckenleuchten · ceiling lamps

91.110.01*	130
91.110.05*	130
91.110.06*	130
91.120.01*	130
91.120.05*	130
91.120.06*	130
91.267.03	139
91.267.05	139
91.267.06	139
91.268.03	139
91.268.05	139
91.269.03	140
91.269.05	140
91.270.03	140
91.270.05	140
91.271.03	142
91.271.05	142
91.277.03	129
91.277.05	129
91.280.03	132
91.280.05	132
91.280.06	132
91.281.03	133
91.281.05	133
91.281.06	133
91.284.03	135
91.284.05	135
91.284.06	135
91.289.19	131

Artikel-Nr. · article-no.	Seite · page
91.289.30	131
91.299.03	141
91.299.05	141
91.301.03	141
91.301.05	141
91.305.03	127
91.305.05	127
91.307.03	129
91.307.05	129
91.308.03	127
91.308.05	127
91.309.03	128
91.309.05	128
91.310.03	133
91.310.05	133
91.311.03	134
91.311.05	134
91.312.05	120
91.312.51	120
91.312.52	120
91.312.54	120
91.313.05	123
91.313.51	123
91.313.52	123
91.313.54	123
91.324.03	137
91.324.05	137
91.325.03	137
91.325.05	137
91.325.06	137
91.326.01	130
91.326.05	130
91.326.06	130
91.327.03	132
91.327.05	132
91.328.05	124
91.329.05	124
91.330.05	125
91.331.05	125
91.332.19	131
91.333.05	125
Zubehör zur Beleuchtung · accessoires for lighting	
95.001.03	190
95.001.05/20	190
95.002.03	190

Artikel-Nr. · article-no.	Seite · page
95.002.05/20	190
95.003.03	190
95.003.05/20	190
95.004.05/20	190
95.005.03	190
95.005.05	190
95.005.20	190
95.006	
95.009	191
F21.830.05-2	169
F21.830.05-3	169
F21.830.06-2	169
F21.830.06-3	169
F21.830.08-2	169
F21.830.08-3	169
G21.830	169
Schirme · shades	
S 21.823.05	176
S 21.824.05	175
S 21.825.05	175
S 21.826.02	177
S 21.826.05	177
S 21.827.02	178
S 21.827.05	178
S 21.828.02	179
S 21.828.05	179
S 41.618.02	43
S 41.618.04	43
S 41.618.05	43
S 41.687.01	39
S 41.735.02	42
S 41.844.03	39
S 41.844.05	39
S 41.850.xx-11	38
S 41.850.xx-12	38
S 41.864.02	41
S 41.864.03	41
S 41.864.19	41
S 41.888.xx-10	29
S 41.888.xx-11	29
S 41.890.xx-10	32
S 41.890.xx-11	32
S 41.903.23	37
S 41.912.xx-10	40
S 41.912.xx-11	40

Artikel-Nr. · article-no.	Seite · page
S 41.933.xx-10	28
S 41.933.xx-11	28
S 41.947.05	33
S 41.948.xx-10	35
S 41.948.xx-11	35
S 41.948.xx-12	35
S 41.952.xx-10	27
S 41.952.xx-11	27
S 41.953.xx-10	30
S 41.953.xx-11	30
S 41.956.xx-10	31
S 41.956.xx-11	31
S 51.193.03	163
S 51.193.04	163
S 51.193.05	163
S 51.294.01	162
S 61.274.01	115
S 61.471.01	115
S 61.581.23	111
S 61.585.23	111
S 61.613.05	113
S 61.614.05	112
S 71.302.02	114
S 71.302.03	114
S 71.302.19	114

* = Leuchten werden ohne Leuchtmittel geliefert
 (* = lamps without bulbs)

Hinweis: Leuchtmittel-Empfehlungen beziehen sich auf
 OSRAM-Produkte, Stand 2015

Die technischen Inhalte entsprechen dem Stand bei Druck des
 Kataloges. Änderungen bleiben vorbehalten. Bitte informieren Sie
 sich bei dem für Sie zuständigen Vertriebsinnen- oder Vertriebs-
 außendienst. Für Satzfehler und Farbabweichungen wird keine
 Haftung übernommen. Stand: August 2015

Knapstein
 G E R M A N Y

GEBRÜDER KNAPSTEIN GMBH

Buchholz 1
 D-59846 Sundern/Sauerland
 Postfach 1238
 D-59832 Sundern/Sauerland

Fon: +49 (29 33) 97 17 - 0
 Fax: +49 (29 33) 97 17 - 40
 www.knapstein-germany.de
 info@knapstein-germany.de

Allgemeine Geschäftsbedingungen

Soweit nicht ausdrücklich andere schriftliche Vereinbarungen getroffen sind, gelten folgende Bedingungen als rechtsverbindlich:

Angebote verstehen sich in allen Teilen freibleibend, deren Abgabe verpflichtet uns also nicht zur Auftragsannahme.

Alle durch unsere Vertreter getroffenen Vereinbarungen, wie überhaupt sämtliche mündlichen Abmachungen bzw. telefonischen oder telegrafischen Mitteilungen, sind für uns erst nach schriftlicher Bestätigung durch uns rechtsverbindlich.

Alle Preise sind freibleibend. Eine Erhöhung der Löhne, Gehälter, des Materials usw. berechtigt uns, die Preise und Zahlungsbedingungen entsprechend zu ändern.

Lieferfristen werden von uns nach Möglichkeit eingehalten, sind aber stets unverbindlich, Ereignisse höherer Gewalt, wozu auch Betriebsstörungen usw. rechnen, entbinden uns von unserer Lieferungsverpflichtung. Das gleiche gilt bei nicht ordnungsgemäßer Erfüllung unserer Kaufverträge seitens unserer Unterlieferanten. Inverzugsetzungen, Verzugsstrafen oder sonstige Schadenersatzansprüche wegen verspäteter Lieferung sind ausgeschlossen. Lieferungsüberschreitungen geben dem Käufer nicht das Recht, vom Verträge zurückzutreten, ohne eine angemessene Nachfrist zu setzen. Mengenabweichungen bis zu 10% mehr oder weniger sind zulässig. Allen Maßen liegen die handelsüblichen Schwankungen zugrunde.

Lieferung erfolgt ab unserem Werk ausschließlich Verpackung. Innerhalb von Deutschland liefern wir ab EUR 750,00 netto (o. MwSt.) frei Empfangsstation. Warenumschiebungen werden selbstkostend berechnet. Eine Rückgabe von Karton- und Paketverpackungen ist ausgeschlossen. Versand erfolgt stets auf Gefahr des Empfängers, auch bei frachtfreier Lieferung.

Die Verfrachtung wird nach bestem Ermessen ohne jede Verbindlichkeit für billigste Verfrachtung vorgenommen, wenn der Besteller besondere Weisungen dafür nicht gegeben hat.

Mängelrügen können in allen Fällen nur spätestens 10 Tage nach Empfang der Ware Berücksichtigung finden.

Unsere Rechnungen sind zahlbar innerhalb 30 Tagen nach Rechnungsdatum rein netto ohne Abzug, innerhalb 14 Tagen nach Rechnungsdatum unter Abzug von 2% Skonto.

Bei Überschreitung der Zahlungsfrist sind wir berechtigt, vom Verfalltage an Zinsen und Spesen zu berechnen, welche die deutschen Großbanken für ungedeckte Kredite verlangen. Akzente nehmen wir entgegen, wenn der Verfalltag nicht später als 3 Monate nach Rechnungsdatum liegt. Diskontspesen werden in Rechnung gestellt.

Eigentumsvorbehalt: Die von uns gelieferte Ware bleibt unser Eigentum, bis alle unsere gegenwärtigen Ansprüche gegen den Käufer, einschließlich Nebenforderungen und Schadenersatzforderungen, sowie künftige Ansprüche, soweit diese mit der gelieferten Ware im Zusammenhang stehen, erfüllt sind. Der Eigentumsvorbehalt bleibt auch dann bestehen, wenn einzelne Forderungen des Verkäufers in eine laufende Rechnung aufgenommen werden und der Saldo gezogen und anerkannt wird.

Der Käufer ist berechtigt, die in unserem Eigentum stehende Ware (Vorbehaltsware) im ordentlichen Geschäftsgang weiter zu veräußern. Er tritt uns jedoch bereits jetzt alle Forderungen aus dieser Weiterveräußerung ab, und zwar gleichgültig ob er die Vorbehaltsware ohne oder nach Verarbeitung weiterveräußert oder ob sie mit einem Grundstück oder mit beweglichen Sachen verbunden wird oder nicht.

Hat der Käufer die Forderung im Rahmen des echten Factorings verkauft, wird die Forderung des Verkäufers sofort fällig und der Käufer tritt die an ihre Stelle tretende Forderung gegen den Factor an den Verkäufer ab und leiht seinen Verkaufserlös unverzüglich an den Verkäufer weiter. Der Verkäufer nimmt diese Abtretung an.

Die Befugnis des Käufers, im ordnungsgemäßen Geschäftsgang Vorbehaltsware zu veräußern, zu verarbeiten oder einzubauen, besteht, solange der Besteller seinen Zahlungsverpflichtungen nachkommt. Die Einziehungsermächtigung erlischt bei Widerruf durch den Verkäufer, spätestens bei Zahlungsverzug des Käufers oder infolge einer nachhaltigen Verschlechterung der Vermögenslage des Käufers, insbesondere bei Zahlungseinstellung oder bei Beantragung bzw. Eröffnung des Konkurs- oder Vergleichsverfahrens über das Vermögen des Käufers. In diesen Fällen wird der Verkäufer hiermit vom Käufer bevollmächtigt, die Abnehmer von der Abtretung zu unterrichten und die Forderung selbst einzuziehen.

Der Käufer verwahrt die Vorbehaltsware für den Verkäufer unentgeltlich. Er hat sie gegen die üblichen Gefahren wie z.B. Feuer, Diebstahl und Wasser im gebräuchlichen Umfang zu versichern. Der Käufer tritt hiermit seine Entschädigungsansprüche, die ihm aus den Schäden der o. g. Art gegen Versicherungsgesellschaften oder sonstige Ersatzverpflichtete zustehen, an den Verkäufer in Höhe des Fakturenwertes der Ware ab. Der Verkäufer nimmt die Abtretung an.

Verpfändungen oder Sicherungsübereignung der Vorbehaltsware bzw. der abgetretenen Forderungen sind unzulässig. Von Pfändungen ist der Verkäufer unter Angabe des Pfandgläubigers sofort zu benachrichtigen.

Wird aufgrund des Eigentumsvorbehaltes der Liefergegenstand zurückgenommen, so liegt nur dann ein Rücktritt vom Vertrag vor, wenn der Verkäufer dies ausdrücklich erklärt. Der Verkäufer kann sich aus der zurückgenommenen Ware durch freihändigen Verkauf befriedigen.

Sämtliche Forderungen sowie die Rechte aus dem Eigentumsvorbehalt an allen in diesen Bedingungen festgelegten Sonderformen bleiben bis zur vollständigen Freistellung aus Eventualverbindlichkeiten, die der Verkäufer im Interesse des Käufers eingegangen ist, bestehen.

Nichteinhaltung der vereinbarten Zahlungsbedingungen berechtigt uns, fertige Ware zurückzubehalten und von der Lieferungsverpflichtung zurückzutreten. Bei Lieferung an Abnehmer, über deren Solvenz wir nicht näher unterrichtet sind, behalten wir uns vor, Vorauszahlung oder hinreichende Sicherstellung der Rechnungsbeträge, auch nach erfolgter Bestätigung unsererseits, zu beanspruchen. Die Ware bleibt bis nach erfolgter völliger Zahlung – bei Zahlung in Wechseln, Schecks oder sogenannten Zahlungsmitteln bis nach erfolgter Einlösung derselben – unser ausschließliches Eigentum. Geht der Eigentumsvorbehalt ganz oder teilweise unter, so tritt an seine Stelle das Recht auf Aussonderungen von Forderungen an die Schuldner unserer Kunden bis zur Höhe der noch verbleibenden Schulden.

Für irgendwelchen unterwegs entstehenden Bruch wird kein Ersatz geleistet.

Einkaufsbedingungen unserer Auftraggeber sind nur dann für uns verbindlich, wenn sie ausdrücklich und schriftlich von uns anerkannt sind. Erfüllungsort für Lieferung und Zahlung für beide Teile, auch für Wechselverbindlichkeiten ist Sundern/Sauerland, Gerichtsstand Arnberg.

Die angegebenen Preise stellen eine unverbindliche Preisempfehlung für den Endverbraucher dar.

General Conditions

Unless other agreements have been expressly made in writing, the conditions given below are regarded as being legally binding:

All components of offers are non-binding and the issuing of these does not therefore oblige us to accept an order.

All agreements made by our representatives, in addition to any form of verbal arrangements made either by telephone or by electronic means, are not regarded by us as being legally binding until they have been confirmed in writing.

All prices are subject to confirmation. An increase in wages, salaries, materials etc. gives us the right to suitably modify the prices and payment conditions.

Delivery dates will be maintained by us where possible but are in any case non-binding; acts of God and operational disruptions etc. will release us from our agreed delivery obligation. This also applies to non-performance or improper performance of purchase contracts by our sub-suppliers. Any measures, penalties for delay or other such claims for damages for delays in delivery are excluded. Any exceeding of the delivery date does not give the purchaser the right to withdraw from the contract without setting a suitable period of grace. Variations in quantity supplied of up to 10% more or less are permissible. All measurements are subject to the variations customary within the trade.

Delivery is made ex-works our plant, exclusive of packaging. From a net value of 750.00 euros (excl. German VAT) upwards we supply within Germany delivered to the receiving station. Packing is charged at cost. A return of cardboard and other forms of packaging is excluded. Delivery is carried out in all cases at the risk of the receiver, even in cases where delivery is free domicile.

The form of transportation will be chosen with suitable care and without any obligation with regard to the choice of the cheapest form of transportation, if this is not otherwise expressly requested by the ordering party.

In all cases complaints will only be taken into consideration if they are made at the latest 10 days after receipt of the goods.

Our invoices must be paid in full without any discount within 30 days of the date of the invoice; however a discount of 2% is given for payment within 14 days of the date of the invoice.

Where the deadline for payment is exceeded we have the right to charge that interest and expenses from the due date which German major banks demand for unsecured loans. We will receive bills of acceptance if the due date is not later than 3 months after the date of the invoice. Any discount fees will be charged separately.

Title retention: The goods supplied by us remain our property until all our current claims against the purchaser have been cleared, including all incidental related costs and claims for damages and any future claims, where these are in relation to the goods supplied. Title retention also remains if individual claims on the part of the seller have been brought together in one invoice and the balance has been drawn and acknowledged.

The purchaser has the right to sell on in the normal course of business those goods to which we retain title. However he shall assign to us here and now any claims arising from this onward sale, independently of whether the goods were sold on before or after being processed or whether they are combined with a plot of land or with moveable property or not.

If the purchaser has sold the claim as part of a genuine factoring process, the seller's claim will become due immediately and the purchaser will pass any claims on the factor which takes its place and will transfer his proceeds from the sale to the seller without delay. The seller will accept this assignment.

The authorization of the purchaser to sell or process the goods or to assemble them onto other parts in the course of business will continue to exist as long as the purchasing party meets his payment obligations. The authorization to recover expires upon a retraction by the seller, at the latest when there is a delay in payment by the purchaser or as a result of a lasting deterioration in the buyer's financial situation, in particular where there is a suspension of payment or where bankruptcy or receivership proceedings are initiated in relation to the buyer's property. In such cases the seller is hereby authorized by the buyer to inform his buyers of the assignment and to collect the claims himself.

The purchaser will retain the goods for the seller at no extra cost. He must insure them against common hazards, such as fire, theft and flood to a customary extent. In doing this the purchaser waives all claims to damages which may be due to him from insurance companies or other liable parties as a result of damages of the above forms in favour of the seller to the amount of the invoiced value of the goods. The seller will accept this assignment.

Pledges or the granting of security on the goods or on the assigned claims are not permitted. The seller must be immediately informed of any pledges and of the identity of the pledgee.

If the merchandise is reclaimed as a result of a reservation of title, then the contract will only be considered as terminated if this is expressly declared by the seller. The seller can satisfy his claims on the goods by a sale on the open market.

All claims and rights to title as covered by all these special conditions and forms remain in existence until the complete release from contingent liabilities which the seller has accepted in the interest of the purchaser.

Non-compliance with the agreed payment conditions gives us the right to retain completed goods and to withdraw from any obligation to deliver. Where delivery is made to a buyer whose solvency is unknown to us we retain the right to demand payment in advance or sufficient security to the amount of the invoice, even when confirmation has been made on our part. The goods remain our sole property until full payment has been made – or, where payment is made by bills of exchange, cheques or any so-called means of payment, until these have been fully redeemed. Should the title retention fully or partly lapse, then the right to recover claims on the debtors of our customers will take its place up to the value of the remaining debt.

No replacement will be made for any breakage sustained in transport.

The purchasing conditions of our clients are only binding on us if they have been expressly recognised by us in writing. The place of performance for delivery and payment of both parts and for any bills payable is Sundern/Sauerland, Germany, and the place of jurisdiction is Arnsberg, Germany.

The prices given are intended as a non-binding price recommendation for the end-consumer.

Knapstein
G E R M A N Y

Vertretungen Inland Fachhandel

PLZ-Gebiet 01 - 18	Jörg Hübner	Telefon	0 30/3 63 28 40
PLZ-Gebiet 39	Industrie-Vertretung	Telefax	0 30/3 64 87 28
PLZ-Gebiet 98 - 99	Bauersfeldzeile 3	Mobil	0 172/3 70 57 35
	13593 Berlin - Spandau	eMail	huebner-licht@t-online.de

PLZ-Gebiet 19 - 33	Jan Scholz	Telefon	0 40/7 26 93 742
PLZ-Gebiet 37 - 38, 49	Handelsagentur	Telefax	0 40/7 24 45 30
Rheine + Nordhorn	Am Ohlendiek 31	Mobil	0 171/9 90 15 98
	22113 Oststeinbek	eMail	hv.j.scholz@t-online.de

PLZ-Gebiet 40 - 48	Gebr. Knapstein GmbH	Telefon	0 29 33/97 17 0
PLZ-Gebiet 50 - 53	Buchholz 1	Telefax	0 29 33/97 17 40
PLZ-Gebiet 57 - 59	59846 Sundern	eMail	info@knapstein-germany.de

PLZ-Gebiet 34 - 36	Gebr. Knapstein GmbH	Telefon	0 29 33/97 17 0
PLZ-Gebiet 54 - 56	Buchholz 1	Telefax	0 29 33/97 17 40
PLZ-Gebiet 60 - 69	59846 Sundern	eMail	info@knapstein-germany.de
Korbach			

PLZ-Gebiet 70 - 79	Sven Buhmeier	Telefon	0 77 21/40 96 66
PLZ-Gebiet 88 - 89	Agentur für Licht & Design	Telefax	0 77 21/40 96 67
	Neuer Weg 18	Mobil	0 171/7 73 86 61
	78052 VS-Villingen	eMail	s.buhmeier@t-online.de

PLZ-Gebiet 80 - 87	Miroslav Patocka	Telefon	0 94 93/9 00 50
PLZ-Gebiet 90 - 97	Handelsagentur	Telefax	0 94 93/9 00 51
	Staufferstraße 8	Mobil	0 171/5 25 22 58
	93176 Beratzhausen	eMail	mpatocka@mp-leuchten.com

Vertretung Inland Objekt	Karl Gradl	Telefon	0 96 07/603
	Handelsvertretung	Telefax	0 96 07/1556
	Marktplatz 23	Mobil	0 171/7 70 91 13
	92706 Luhe-Wildenau	eMail	karl.gradl@t-online.de

Vertretungen international

Belgien	Letex Verlichting	Telefon	04 13/24 94 41
	Guus van der Eerden	Mobil	06 53/44 22 56
	Franzien van der Eerden	Mobil	06 20/87 99 03
	Niederland	Telefax	04 13/24 68 35
		eMail	info@letexverlichting.com
Dänemark	Heick Interieur	Telefon	29 27 04 12
	Peter Heick	Telefax	-
	Skovgyden 25 A	Mobil	29 27 04 12
	DK - 5230 Odense M.	eMail	info@peter-heick.dk
Finnland	Candela Import Oy	Telefon	9-6 22 33 01
	Krämertintie 17	Telefax	9-6 22 34 22
	FI - 00620 Helsinki	eMail	info@candelaimport.fi
Frankreich	SARL Luc Eclairage	Telefon	0033/4 74 70 48 17
	Luc Campagna	Telefax	0033/4 74 72 35 46
	Za de Charpenay	Mobil	0033/6 14 70 38 74
	13, Allee des joncs	eMail	luc.eclairage@orange.fr
	F - 69210 Lentilly		
Luxemburg	Gebr. Knapstein GmbH	Telefon	0 29 33/97 17 0
	Buchholz 1	Telefax	0 29 33/97 17 40
	59846 Sundern	eMail	info@knapstein-germany.de
Niederlande	Letex Verlichting	Telefon	04 13/24 94 41
	Guus van der Eerden	Mobil	06 53/44 22 56
	Franzien van der Eerden	Mobil	06 20/87 99 03
	Niederland	Telefax	04 13/24 68 35
		eMail	info@letexverlichting.com
Österreich Südtirol	Klaus Strimitzer	Telefon	0 36 85/2 42 10
	KS-Licht Handelsagentur	Telefax	0 36 85/2 37 10
	Wamprechtsamerstraße 739	Mobil	06 64/3 84 41 12
	A - 8962 Gröbming	eMail	info@ks-licht.at
Schweiz	MONDILUX AG	Telefon	0 61/976 92 00
	Boris Schönenberger	Telefax	0 61/976 92 10
	Gewerbestraße 12	Mobil	079 322 35 00
	CH - 4450 Sissach	eMail	b.schoenengerger@mondilux.ch
Tschechien	LUMINEX spol. s.r.o.	Telefon	2 61 09 09 50
	Petra Rezka 10/1203	Telefax	2 61 21 58 75
	CZ - 14000 Praha 4	eMail	miroslav.patocka@luminex.cz
Vertretung Österreich Objekt	Peter Strebinger	Telefon	0043/26 22 24 731
	Handelsagentur	Telefax	-
	Nikolaus Lenaugasse 17	Mobil	0043/664 10 38 923
	A - 2700 Wiener Neustadt	eMail	p.strebinger@strebinger.at

Die technischen Inhalte entsprechen dem Stand bei Druck des Kataloges. Änderungen bleiben vorbehalten. Bitte informieren Sie sich bei dem für Sie zuständigen Vertriebsinnen- oder Vertriebsaußendienst. Für Satzfehler und Farbabweichungen wird keine Haftung übernommen.

Stand: August 2015

Knapstein
G E R M A N Y

GEBRÜDER KNAPSTEIN GMBH

Buchholz 1
D-59846 Sundern/Sauerland
Postfach 1238
D-59832 Sundern/Sauerland

Fon: +49 (29 33) 97 17 - 0
Fax: +49 (29 33) 97 17 - 40
www.knapstein-germany.de
info@knapstein-germany.de