

ANGLEPOISE®

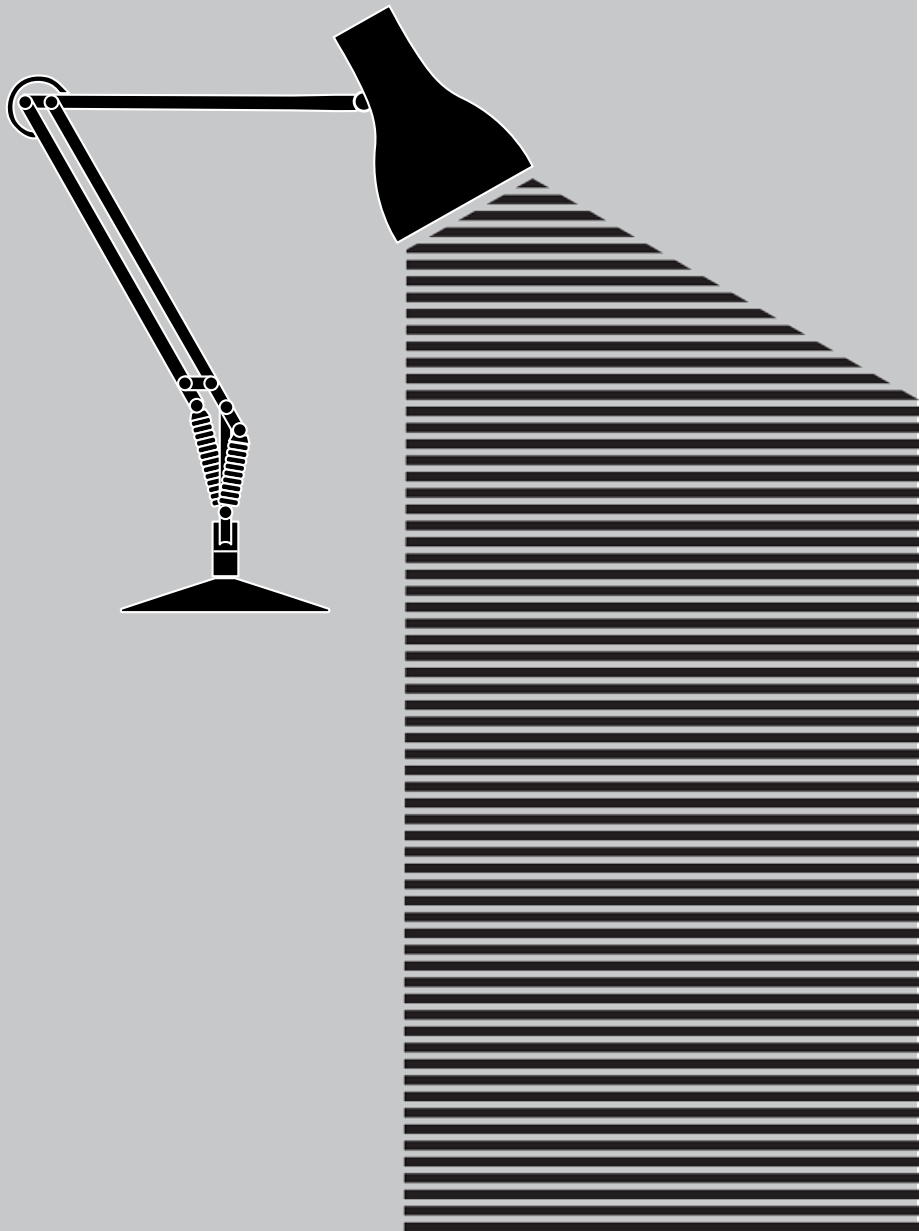

It's not often you inherit an instantly recognisable product with such a distinct personality... part of the language of things that are so very British. Therefore, following in the footsteps of four generations, my challenge has been to allow the brand to evolve into a contemporary lighting company without losing sight of its heritage.

I'm proud to be part of a growing and committed team drawn together by our 'Great Place to Work' culture, which puts the customer at the core of everything we do. In addition, since 2003, we've benefited enormously from our ongoing collaboration with industrial product designer Sir Kenneth Grange, aptly labelled the 'godfather of modernism'. His relentless work ethic is an inspiration to us all and has fuelled our passion for honesty of materials and creating products that are a pleasure to use.

Maintaining a product's functionality and relevance is fundamental, so this year we're launching a series of colour-matched accessories to complement our Original and Type ranges and enhance fixing options. We've introduced new metallic finishes to give a more sophisticated look and feel to our popular Type range and a new material, bone china, into our Original range.

Meanwhile our distribution across the globe continues at a pace, with our New York office now well established, and strong relationships in place with partners across Europe, Asia and Australia.

Simon Terry
Brand Director



Contents

About	4
About Us	6
Our Story	8
Product Heritage	10
George Carwardine	12
Sir Kenneth Grange	13
New Collections	14
Original 1227™ Mini Ceramic	16
Type 75™ Mini Metallic	20
Type 1228™ Metallic	26
Type 1228™	30
Collections	34
Anglepoise® + Paul Smith	36
Anglepoise® + Margaret Howell	38
Original 1227™ Mini	42
Original 1227™	46
Original 1227™ Brass	52
Original Range Accessories	56
Original 1227™ Giant	62
Original 1227™ Giant - Outdoor	66
Original 1227™ Giant - Brass	70
Type 75™ Mini	74
Type 75™	78
Type Range Accessories	82
Type 75™ Maxi	88
Type 75™ Giant	92
Product Reach	96
Anglepoise® Projects	98
Product Index	114
Credits	124

About Us
Our Story
Product Heritage
George Carwardine
Sir Kenneth Grange



About Us

“From small beginnings come great things”

In 1932, when vehicle suspension engineer George Carwardine invented a spring, crank and lever mechanism that could be positioned with the lightest of touch yet would maintain its position once released, a blueprint for the first Anglepoise® task lamp was born. The Anglepoise® lamp has subsequently achieved iconic status and its engaging, anthropomorphic form is recognised and admired all around the world.

Over the years the Anglepoise® lamp has been developed under the careful watch of the founding Terry family without ever losing sight of its primary function, and unique, characterful form. From the creation of the Original 1227™ lamp, to the development of extended collections by esteemed industrial product designer Sir Kenneth Grange, to recent collaborations with renowned designers Paul Smith and Margaret Howell, incomparable British design remains at the heart of this progressive British brand. Today, Anglepoise® lamps can be found in homes and offices, restaurants, bars and hotels in more than 50 countries.

Not so surprising then that the new London Design Museum should devote a section on the Anglepoise® lamp in their permanent exhibition, nor that the Royal Mail should celebrate our Original1227™ design alongside such fine British design classics as the Mini, Penguin books and the Routemaster Bus.

2009: Royal Mail stamp collection issued to celebrate British Design Classics, includes iconic Anglepoise® Original 1227™ design.



@Anglepoise



Our Story

Invented by a car designer

In 1932 automotive engineer George Carwardine develops a formula for a new type of spring. He discovers that pivoting arms supported by a sequence of these springs can be repositioned with the lightest touch yet will remain perfectly in place once released. Carwardine has just created the blueprint for an Anglepoise®.

Licensed to a spring maker

Carwardine turns to world-class spring makers Herbert Terry and Sons to manufacture his design. Terry's is one of the few companies able to produce springs of such complexity. The Anglepoise® name is registered and under licence to Terry's the first Anglepoise® lamp, the 4-spring Model 1208™ is launched.

Reworked for a domestic market

Considering the four-spring Anglepoise® too industrial for a domestic market, Carwardine and Terry's designers develop a three-spring version. The Original 1227™ they launch in 1935 is generally considered the archetypal Anglepoise®.

Practical, efficient & built to last

The flexible Anglepoise® shade is designed to concentrate the beam for maximum efficiency and the durable structure of the lamp is cast in metal. So, when a World War 2 bomber fitted with an Anglepoise® navigators lamp is salvaged from Loch Ness in 1985, remarkably the lamp still works.

Capturing the Zeitgeist

The anthropomorphic quality of the Anglepoise® lamp design has long inspired musicians, artists, designers and writers. In 1977 amateur filmmaker Peter Ryde releases 'Wranglepoise', a charming video short that brings the very human characteristics of the lamp into the limelight.



Enter the big friendly Giant

Anglepoise® is approached by the Roald Dahl Museum & Story Centre to produce a larger-than-life version of the writer's beloved Original 1227™ lamp. The Giant 1227™ generates considerable interest and is soon in volume production. 2016 marks the evolution of the Giant into a substantial collection including the first Anglepoise® lamps for outdoors.

Maintaining design excellence

Having previously identified the Anglepoise® as a 'minor miracle of balance, in 2003 esteemed British industrial product designer Sir Kenneth Grange, responsible for some of Britain's most iconic and successful designs including the Kodak Instamatic, the Intercity 125 train and the updated London taxi, becomes Design Director of Anglepoise®.

A champion of modernism

In 2004 renowned British fashion designer Margaret Howell, a longstanding admirer of British modernism, launches a limited edition, re-coloured version of Grange's Type 3™ desk lamp. Subsequent collaborations see an exclusive Type 75™ desk lamp reworked in Yellow Ochre, Seagrass and Saxon Blue.

Achieving design classic status

In 2009, in recognition of its iconic status, the Original 1227™ is featured on a Royal Mail stamp set alongside other pioneering British designs, including the Routemaster Bus, the K2 Telephone Kiosk, the London Underground Map and the Mini.

Innovation continues

2017: Foremost British designer Paul Smith continues an on-going collaboration with Anglepoise®. The Type 75™ desk lamp, designed by Sir Kenneth Grange in 2006, provides the perfect canvas for Paul Smith's masterful colour-by-component approach.

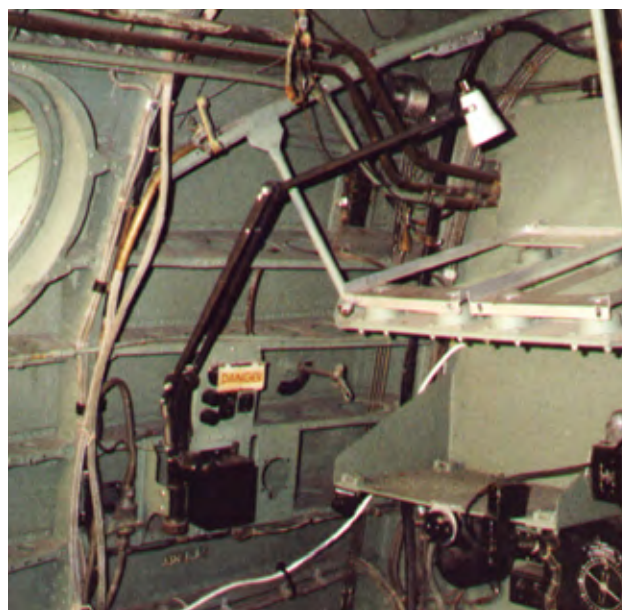
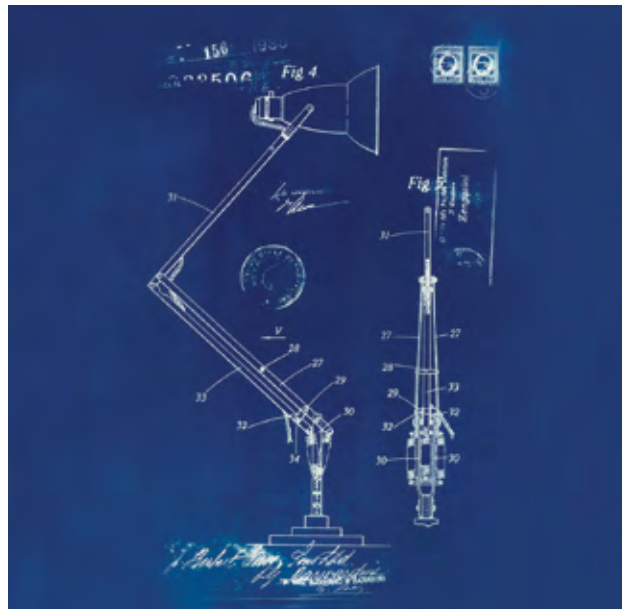

Product Heritage

Anglepoise® has been making its signature sprung lamps since 1932. This pictorial timeline charts the development of our desk lamps over time.

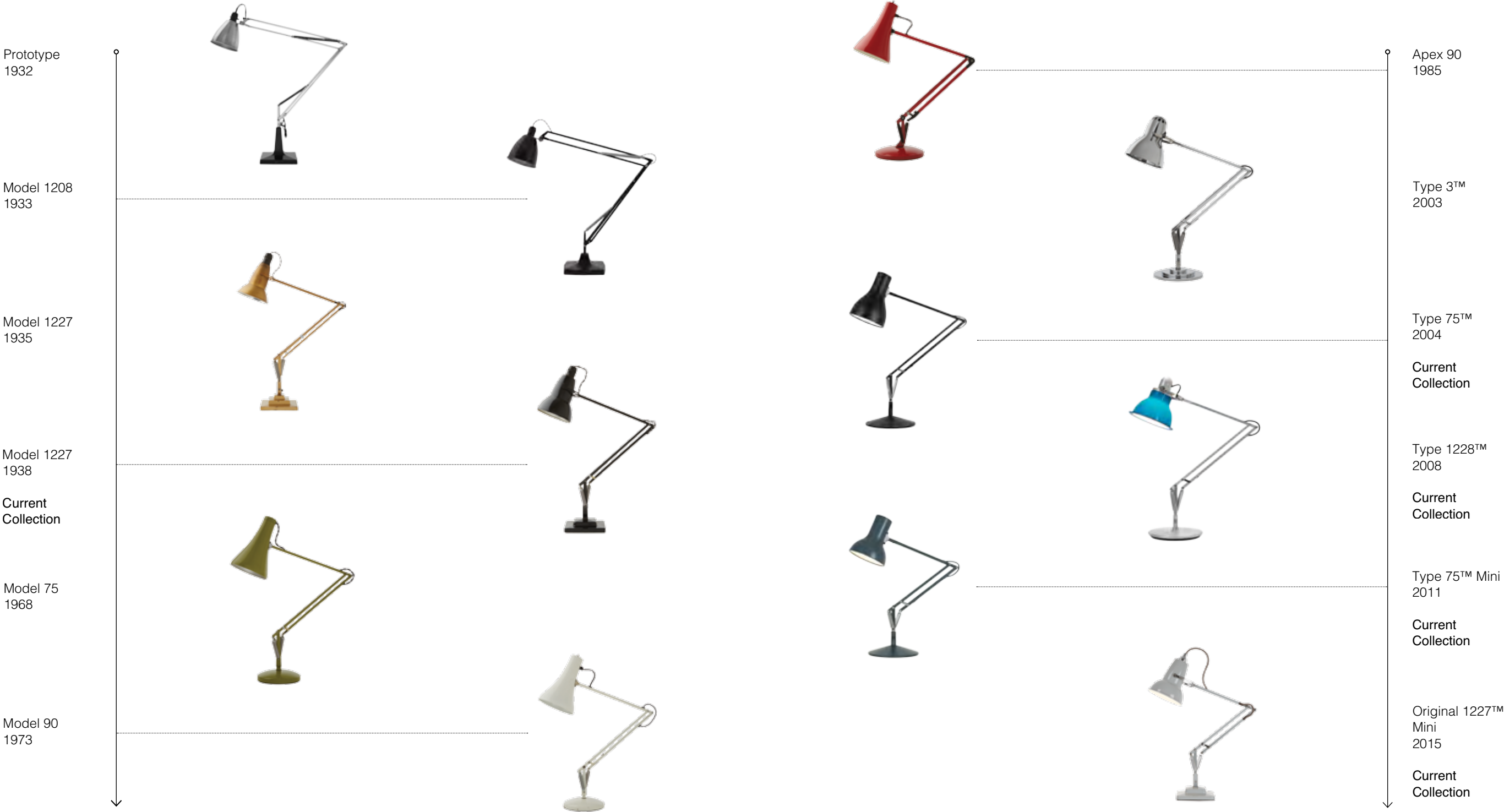

George Carwardine

George Carwardine (1887 - 1947) didn't need to invent the Anglepoise® lamp to make his name; he was already a practicing engineer of some note, specialising in vehicle suspension systems. He honed his skills at the Horstman Car Company where he rose through the ranks to become Chief Designer. Then in 1924, when Horstman's got into financial difficulties Carwardine left to start his own business, which he called Cardine Accessories.

He later went back to work with Sydney Horstman but in 1929 the Horstman car company went bankrupt. Carwardine seized the moment – here was the opportunity he'd been waiting for to explore a longstanding fascination with spring and lever based mechanisms. He established a garden workshop at his home in Bath and began work on the design that would later become his legacy.

By 1932 Carwardine was ready to unveil his remarkable invention - a 4-spring lamp, combining unprecedented freedom of movement and perfect balance due to its patented constant spring mechanism. And soon demand for the lamp far outstripped Carwardine's small-scale supply. So in 1934 Carwardine licensed the design to world-class spring maker, Herbert Terry & Sons, who already supplied the springs for his lamps. Not long after, the Anglepoise® name was registered and the 4-spring 'Model 1208' went into volume production.

Carwardine and the designers at Terry's went straight back to the drawing board, intent on reworking the industrial-style 4-spring design for a domestic market. In 1935 a 3-spring Anglepoise® lamp was released. This was the Original 1227™ - the same design produced to this day.



Sir Kenneth Grange

Design Director of Anglepoise® since 2003, Sir Kenneth Grange began his illustrious career as a technical illustrator whilst in National Service. He subsequently made his reputation as an industrial product designer and in association with four partners founded Pentagram, now an international design practice with offices in USA, Germany and London.

Grange's remarkable work spans half a century and his user-centered, often quintessentially British designs have helped shape the parameters of everyday life for so many. Not only everyday household brands like Kenwood, Parker, Kodak - and of course Anglepoise® - have received the Kenneth Grange treatment but also the InterCity 125 train, the regional Royal Mail postbox and the latest London Black Taxi.

Accolades for Grange's influence as a foremost British product designer have naturally followed. Twice winner of the Prince Philip Designers Prize with a string of Design Council Awards to his name, Grange is a Royal Designer for Industry, Gold Medalist of the Chartered Society of Designers, holds six Honorary Doctorates including at the Royal College of Art where he is visiting professor, and has been awarded both London Design Festival and FX Lifetime Achievement Awards. In 1983 the Victoria & Albert Museum staged a one-man show of his work. Grange was similarly honoured in Tokyo in 1989 and again at the Design Museum 'Making Britain Modern' exhibition in London in 2011. In 1984 Grange was appointed CBE and in 2013 he received a knighthood for services to design.

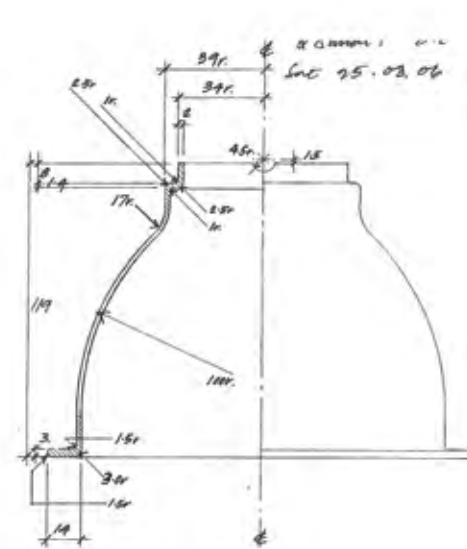
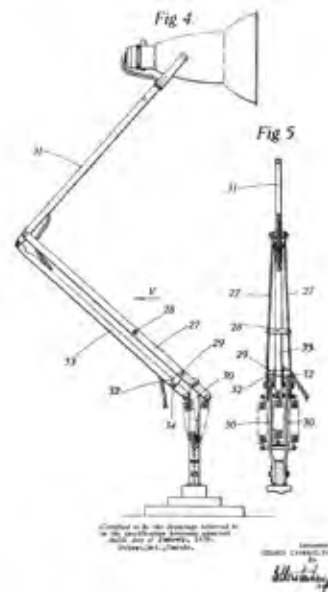

Original 1227™ Mini Ceramic
Type 75™ Mini Metallic
Type 1228™ Metallic
Type 1228™



Original 1227™ Mini Ceramic

2017 marks the launch of Anglepoise®'s four piece, Ceramic collection. Formed from purest bone china, the white, gloss-finished shades turn translucent when the light source is switched on and radiate soft, ambient light around the room. Atmospheric they may be, but we have not sacrificed functionality; the shades on both the table lamp and wall light are flexible so can be adjusted to cast light precisely where it is needed.



Table Lamp



Wall Light



Pendant



Available Colours:

- Pure White

Our new Anglepoise® Ceramic collection exudes simplicity and elegance. The glossy smoothness of the bone china shades are complemented by smart, chrome plated fittings, while the grey fabric cables provide subtle textural contrast. And because accidents can happen, we have made sure that the shades are straightforward to replace.

Pendant Cluster



Additional Pendant cable lengths available on request.

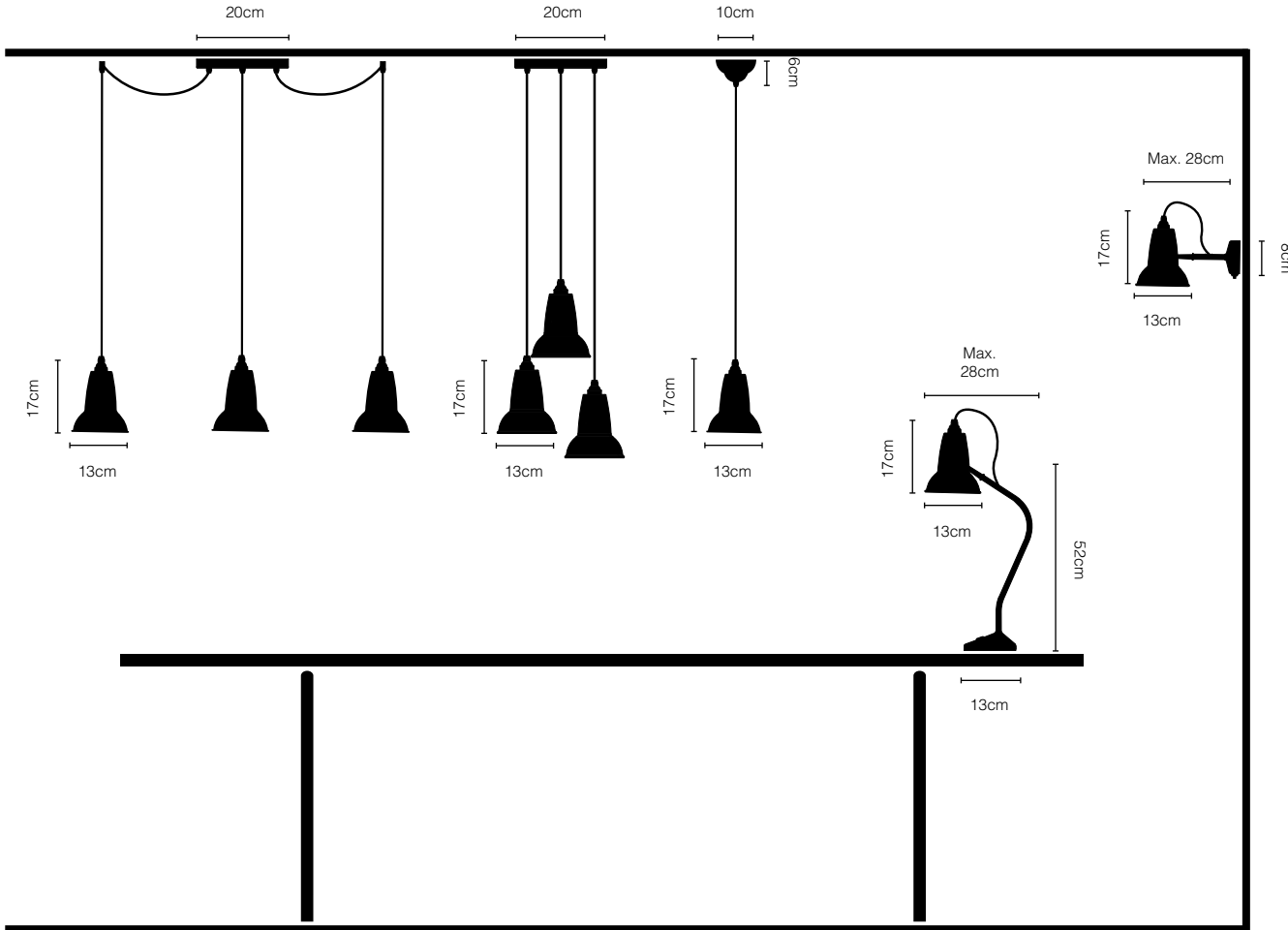

Type 75™ Mini Metallic

Anglepoise® has always blended timeless design with contemporary elegance and this season we are proud to announce that our anodised brushed aluminium finish is now available in Gold and Copper Lustre, as well as the original Silver. Applied to two of our classic designs, the Type 75™ Mini desk lamp and the Type 75™ Mini wall light, our new Metallic Collection brings a beautiful new richness to the functional elegance and faultless engineering that is synonymous with Anglepoise®.





Desk Lamp

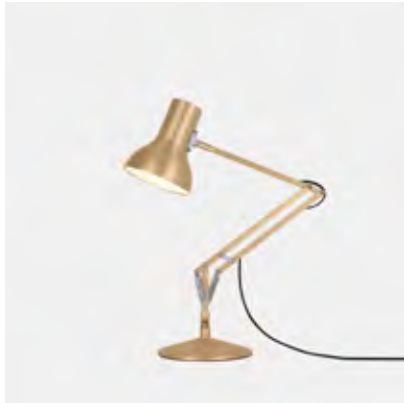

Wall Light

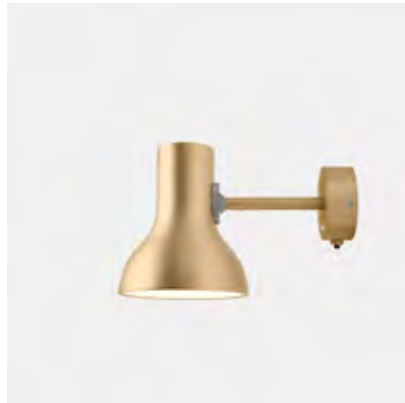

Available Colours:

-  Gold Lustré
-  Silver Lustré
-  Copper Lustré

Refined design details such as a switch that is now seamlessly integrated into the top of the Type 75™ Mini desk lamp's shade, combined with a high specification finish means that the Metallic Collection is a premium range that is as beautiful to use as it is to behold.

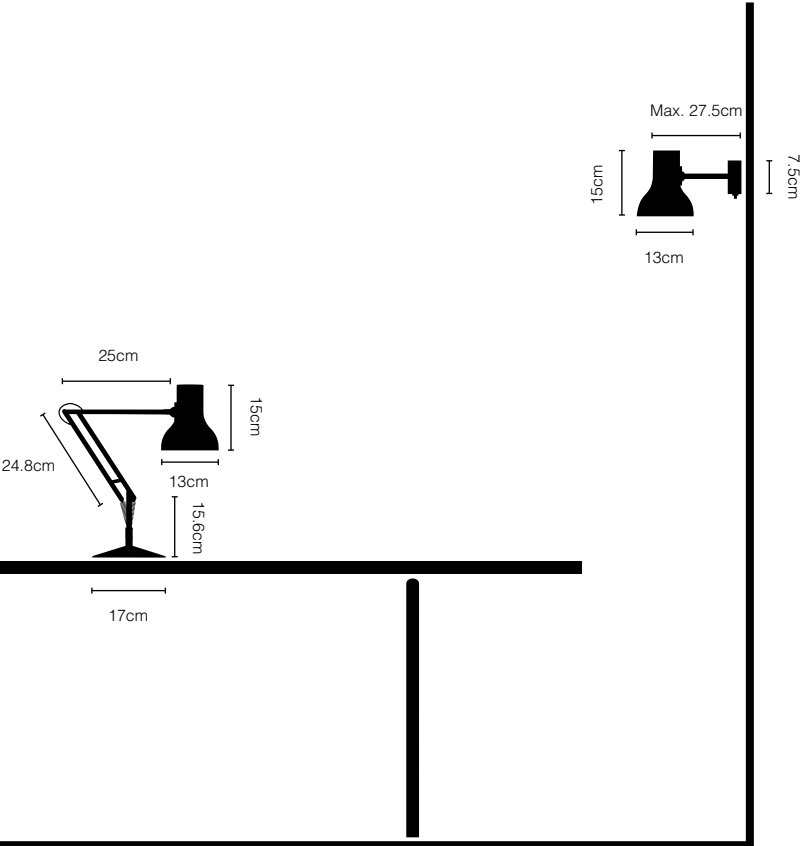

Type 1228™ Metallic



The Type 1228™ Metallic wall light is a premium version of the standard Type 1228™. Now available in three sophisticated, anodised brushed aluminium finishes (Gold, Silver and Copper Lustre) and boasting a switch that has been seamlessly integrated into the top of the shade, this is a rich, high specification refinement of a highly functional wall light.



Wall Light

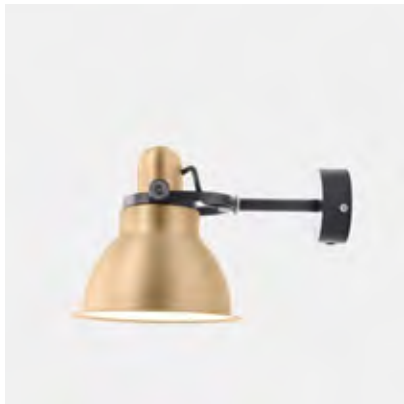

Available Colours:

-  Gold Lustre
-  Silver Lustre
-  Copper Lustre

Anglepoise®'s Type 1228™ Metallic wall light combines the ergonomic functionality of a switch that has been neatly inserted into the top of the shade with the elegant glamour of three different anodised brushed aluminium finishes, making it suitable for any interior where form is as important as function.

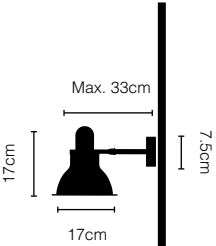

The 2017 versions of the Type 1228™ desk light, wall mounted light and floor light combine Sir Kenneth Grange's original - and much-loved design - with some highly refined updates, including a more streamlined base, an ergonomic switch system and an elegantly pared down colour palette. Now more sophisticated than ever before, these new Type1228™ products are durable and versatile enough for use in any interior.



Desk Lamp

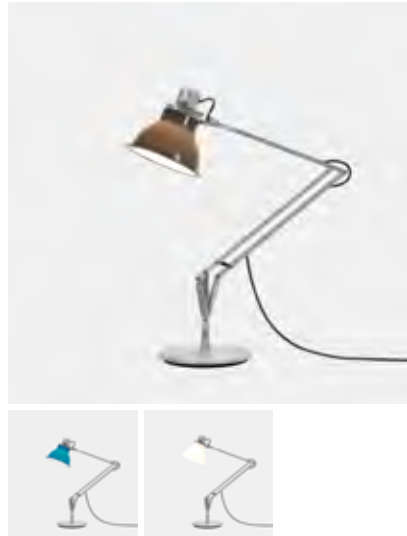

Wall Mounted Lamp

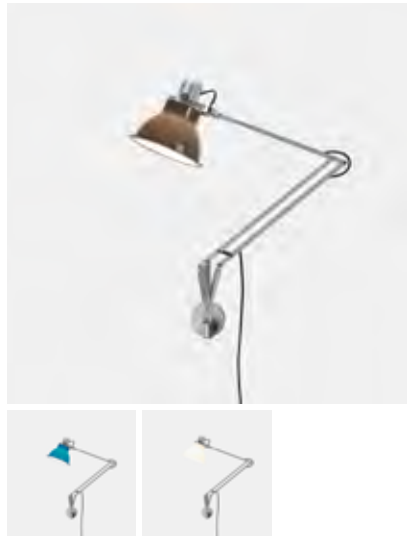

Wall Light

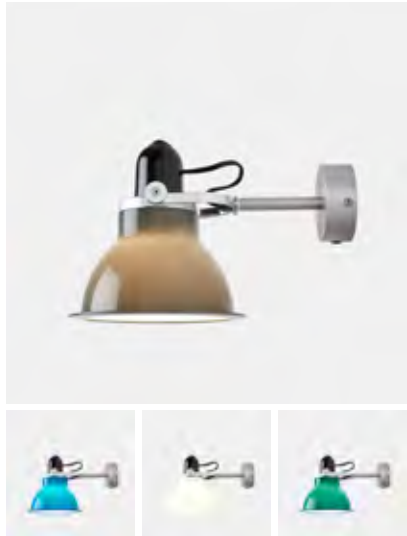

Available Colours:

- Granite Grey
- Ocean Blue
- Ice White
- Minerva Blue (Wall Light only)
- Mid Green (Wall Light only)

The new iterations of our Type 1228™ desk light, wall mounted light and floor light retain all the well-loved features of the originals, including Anglepoise® Constant Tension Spring Technology and that distinctive, hemispherical, twin layered shade, and introduce some new refinements such as an easily accessible, ergonomically designed switch in the top of the shade.

Desk Lamp with Insert

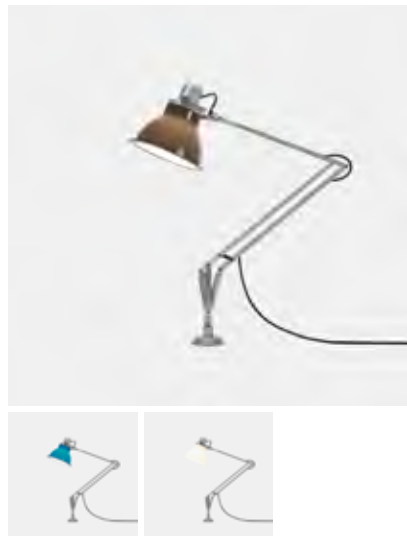

Desk Lamp with Clamp

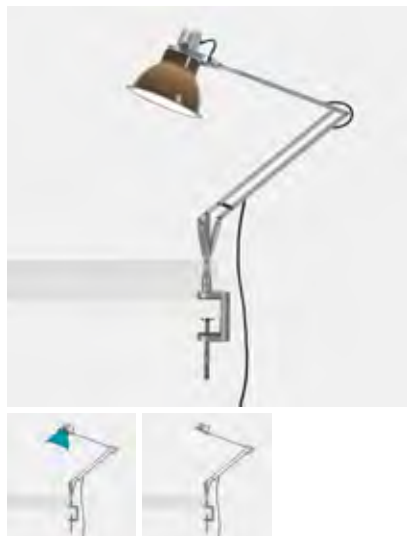

Floor Lamp

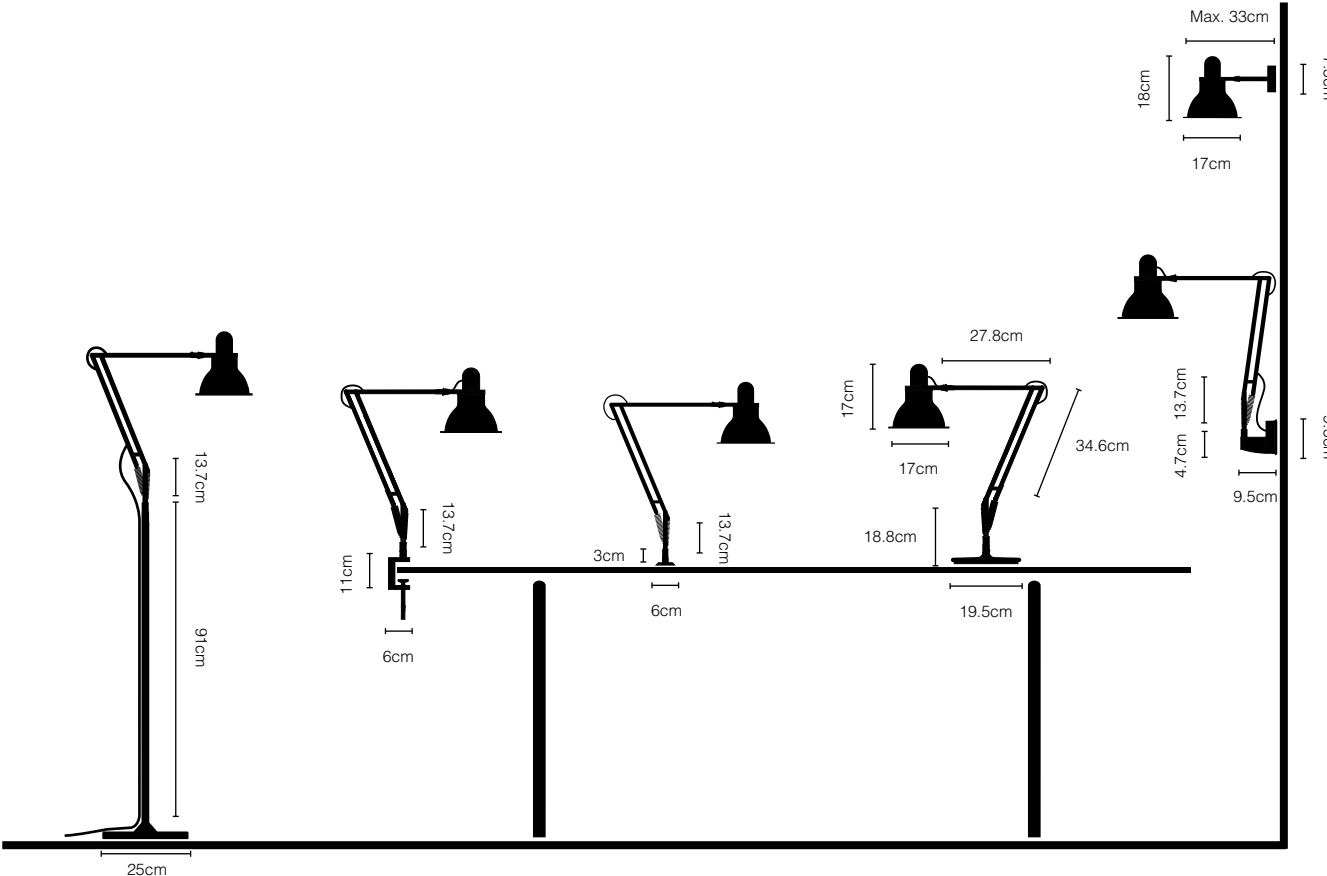
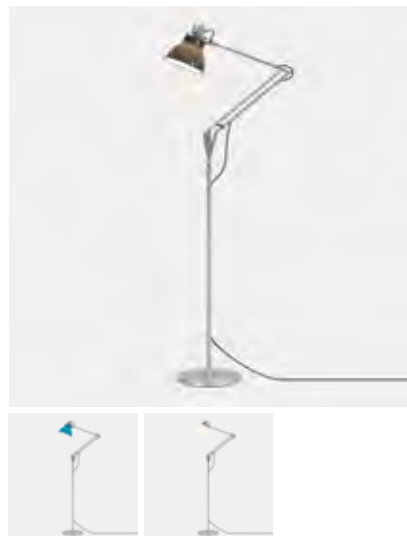

Anglepoise® + Paul Smith
Anglepoise® + Margaret Howell

Original 1227™ Mini
Original 1227™
Original 1227™ Brass
Original Range Accessories

Original 1227™ Giant
Original 1227™ Giant - Outdoor
Original 1227™ Giant - Brass

Type 75™ Mini
Type 75™
Type Range Accessories

Type 75™ Maxi
Type 75™ Giant



Following two stunning collaborations, Anglepoise® and renowned British designer Paul Smith have collaborated once more to create a third edition of the Type 75™ Desk Lamp.

Edition One, with its sunny combination of cornflower, fuchsia and lime is evocative of summer, while Edition Two is its alter ego, evoking the deep, rich hues of autumn.

Edition Three instead uses a strident primary colour palette, inspired by the visual vocabulary of Dutch painter Mondrian's De Stijl style of art, coinciding with De Stijl's centennial.



Esteemed British designer Margaret Howell has frequently championed the Anglepoise® lamp, admiring the similar design qualities that are the essence of her clothing: simplicity, functionality, authenticity and timelessness.

Following the success of the Yellow Ochre Edition, which was colour-matched to an original 1970's Anglepoise® lamp, Margaret added two complementary colours to the collection - Saxon Blue and Seagrass.



Edition One

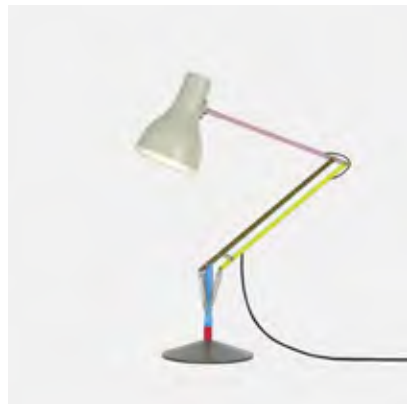

Edition Two



Edition Three

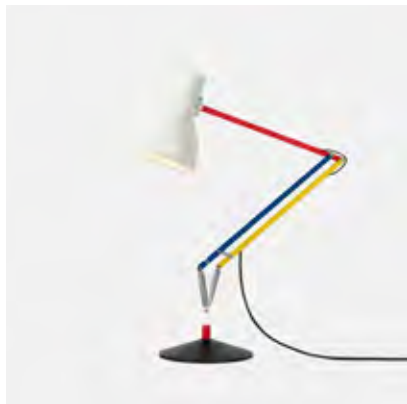

The clean lines, flowing movement and no-frills functionality of Sir Kenneth Grange's classic Type 75™ make it a favourite with designers, so we have collaborated with two of Britain's best on a collection of Type 75™ Editions.

Paul Smith has used his deftness with block colour to highlight the mechanical functionality of the desk lamp.

Modernist aficionado Margaret Howell took a vintage 1970s Anglepoise® Model 90 as the starting point for her collection of desk lamps; an appropriate choice as the Model 90 inspired the very first Type 75™.

Yellow Ochre Edition

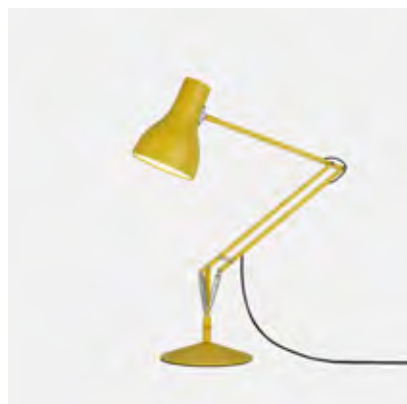

Seagrass Edition



Saxon Blue Edition

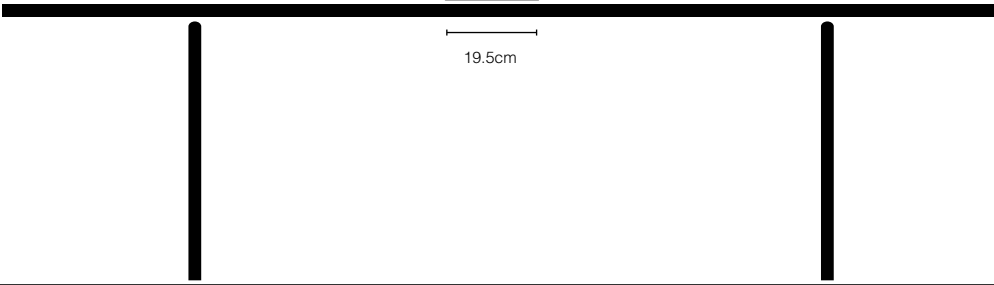
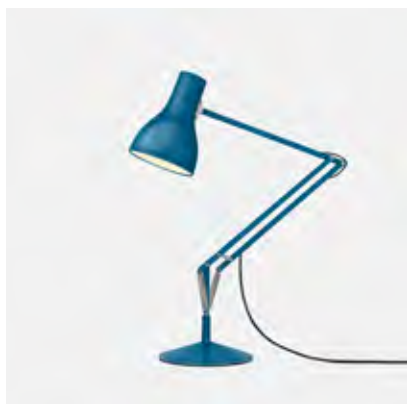

Original 1227™ Mini

The Original 1227™ Mini Collection is the smallest addition to the Original 1227™ family. Diminutive but not diminished, it is playful, versatile, classic and 100% authentic, boasting traditional chrome fittings, our traditional shade shape and plaques etched with the Anglepoise® logo.



Desk Lamp



Table Lamp

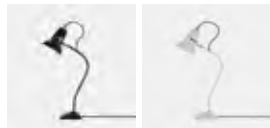

Wall Light



Available Colours:

- Dove Grey
- Jet Black
- Linen White

Scaled down to two-thirds of its original size, the Original 1227™ Mini Collection is playful, more versatile and contemporary version of our most iconic and best loved 1930's Anglepoise® design.

Wall Mounted Lamp



Desk Insert



Desk Clamp

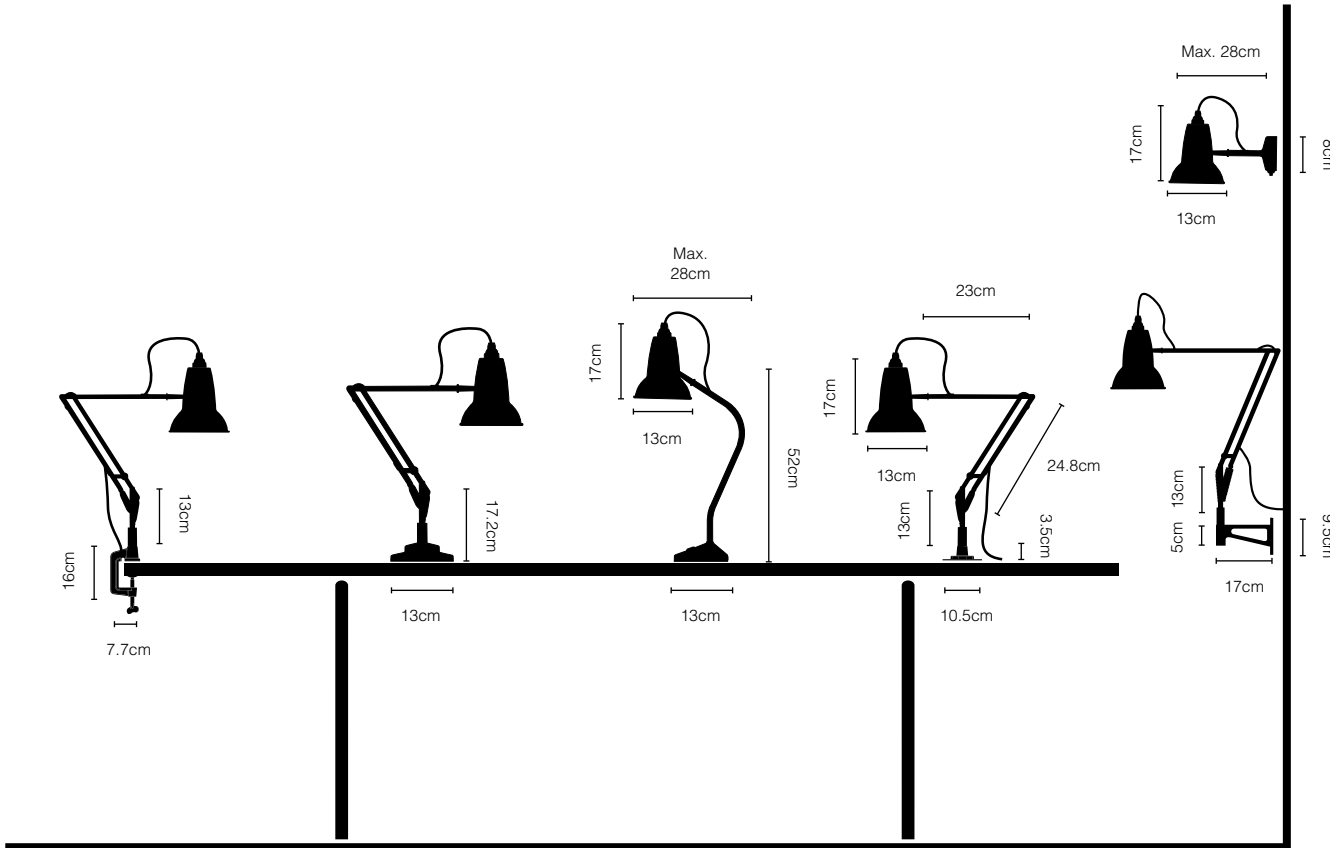
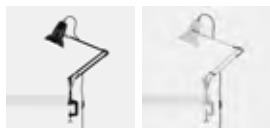



Our Original 1227™ Collection began with a desk lamp. Today, this highly adaptable and engagingly anthropomorphic light, is part of an exemplary nine-piece collection designed for different locations, from table and wall to ceiling and floor. Each piece is available in classic colours, including Linen White and Dove Grey, and comes with toning fabric-covered cord and traditional chrome fittings.

Our Original 1227™ Collection has always boasted unrivalled functionality; now it boasts unrivalled choice too.



Desk Lamp



Floor Lamp

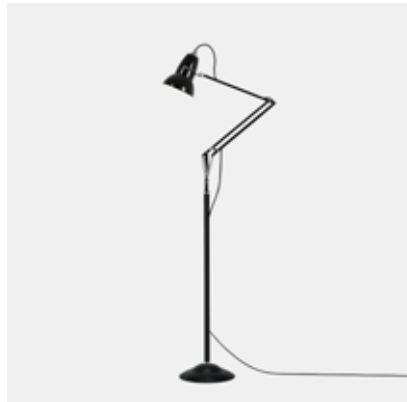

Wall Light



Pendant



Midi Pendant

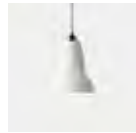

Maxi Pendant

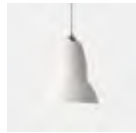

Wall Mounted Lamp



Desk Insert



Desk Clamp





Available Colours:

- Dove Grey
- Jet Black
- Linen White
- Bright Chrome
- Alpine White (Pendant only)

When automotive engineer, George Carwardine chanced upon a formula for a new kind of spring, he had created the blueprint for a groundbreaking articulated task lamp that could combine ultimate flexibility with perfect stability. Two years later the Original 1227™ was born.

Additional Pendant cable lengths available on request.

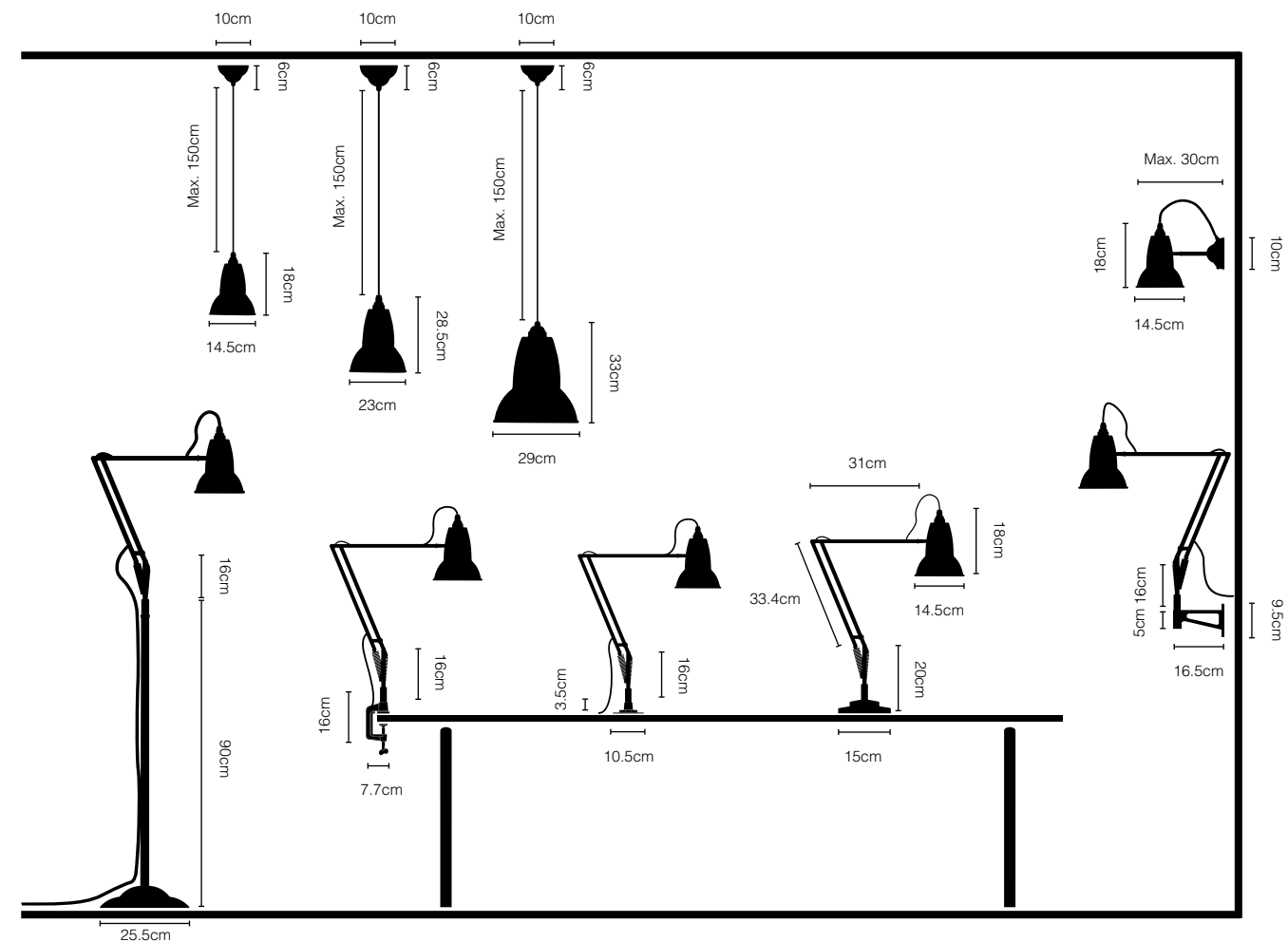

Original 1227™ Brass

With its beautiful, solid brass components, twisted woven fabric cable and chic, high gloss colour palette, this premium five-piece collection is a sophisticated reinterpretation of our classic Original 1227™ design. A perfect blend of form and function, the pendants make a striking feature, while the wall and desk lamps can be re-positioned with the slightest touch and come with adjustable shades that focus the light precisely where it's needed.



Desk Lamp



Wall Mounted Lamp

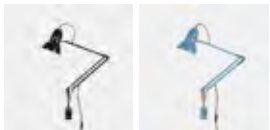

Wall Light



Available Colours:

- Elephant Grey
- Deep Slate
- Dusty Blue

Our Original 1227™ design assumes a sophisticated identity with solid brass components, twisted woven fabric cable and on trend mid-century colour palette.

Additional Pendant cable lengths available on request.

Pendant

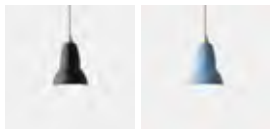
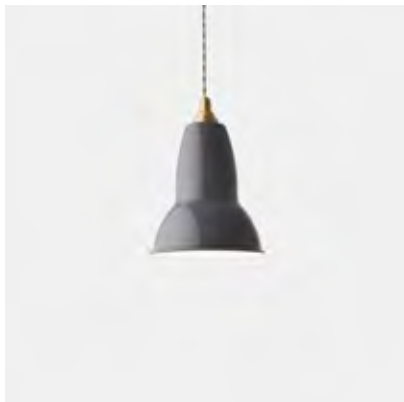

Maxi Pendant

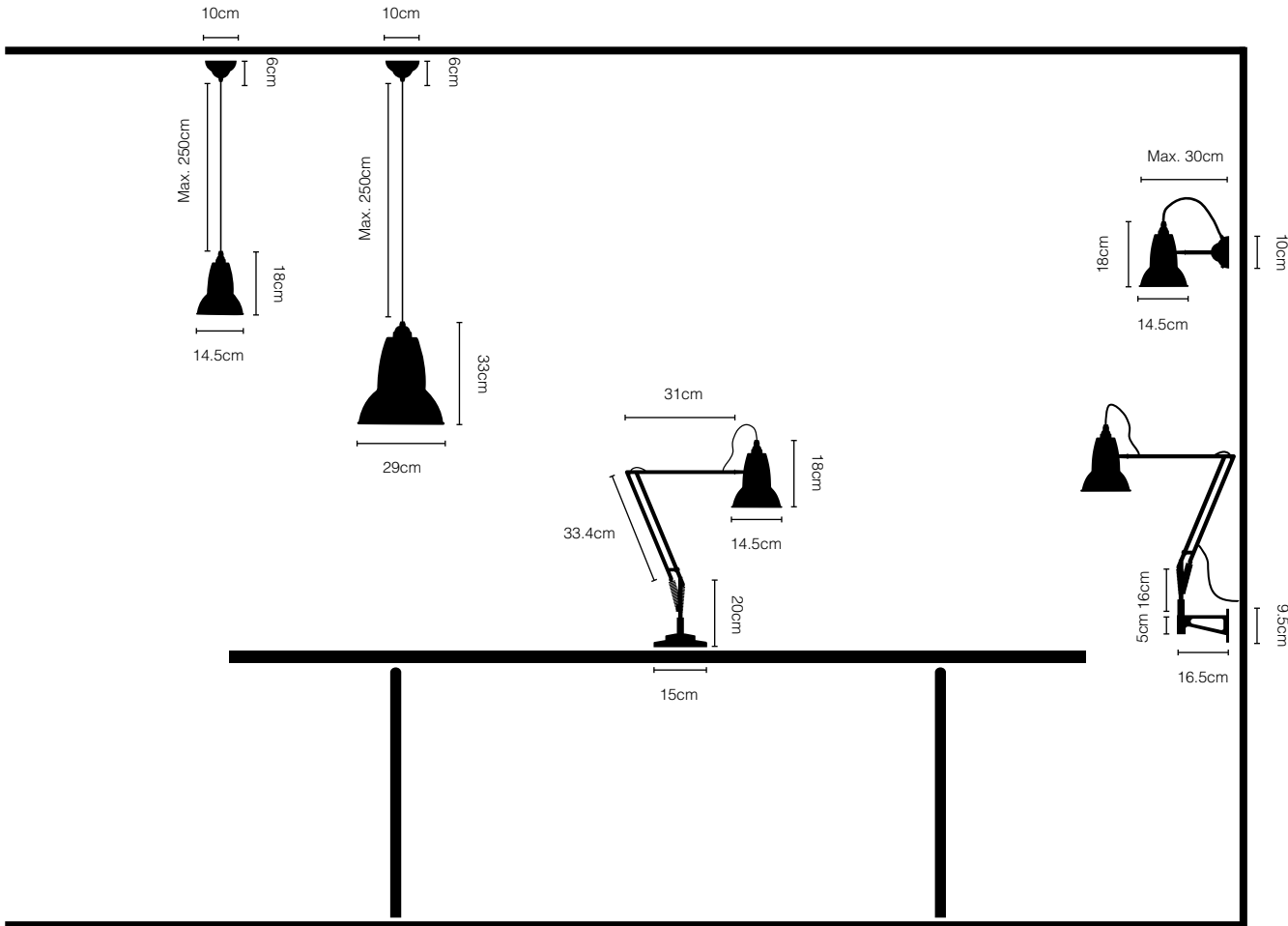
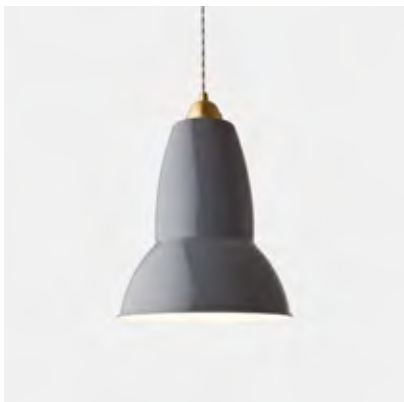

Original Range Accessories

We have developed and refined our new Original Range Accessories to provide total design consistency across the 1227™ and 1227™ Mini collections. The Desk Insert, Desk Clamp, Floor Pole and Wall Bracket have each been carefully colour matched to their corresponding lights, resulting in our most integrated Original Accessories range yet.





Desk Insert

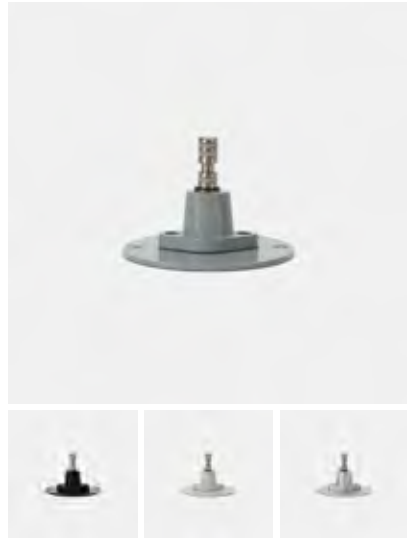

Wall Bracket



Desk Clamp

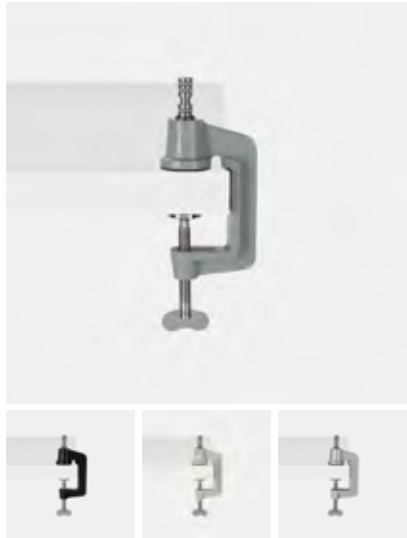

Available Colours:

- Dove Grey
- Jet Black
- Linen White
- Bright Chrome

Our Original Range Accessories have been designed with flexibility in mind. Now colour matched to its corresponding product, each piece is also available as a separate purchase allowing both commercial and domestic customers to use the 1227™ and 1227™ Mini collections in multiple applications for the first time.

Floor Pole

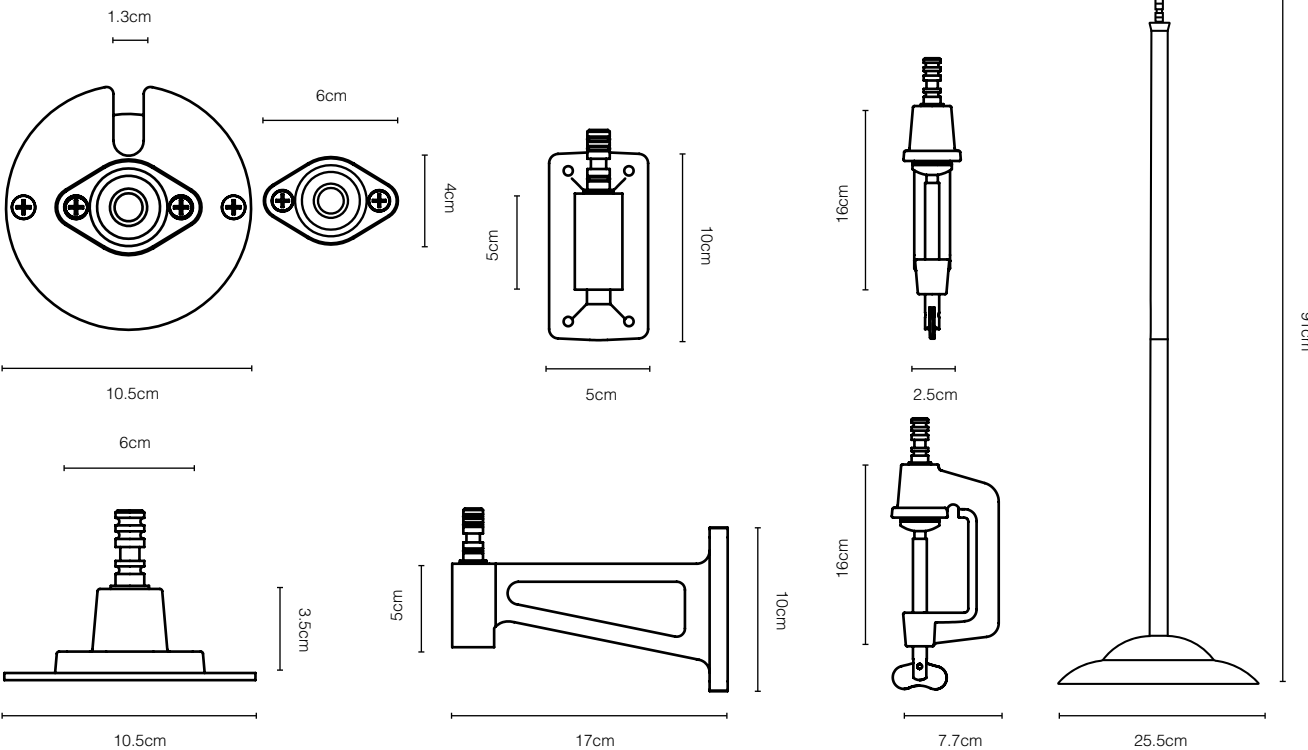

Original 1227™ Giant

The Original 1227™ Giant floor lamp is a beautifully crafted, functional light and an impressive, illuminated sculpture. Three times the size of our iconic Original 1227™ design, it is available in many stunning colours, plus custom options, and will introduce an element of playful, individual style into any interior space. Team with our coordinating pendant shade and new articulated wall-mounted lamp for maximum impact.

RAL
Colour

Customise
Custom colour &
finish available



Floor Lamp



Wall Mounted Lamp



Pendant



Available Colours:

- | | |
|---------------------|---------------------|
| Satin Finish | Gloss Finish |
| ● Jet Black | ● Jet Black |
| ● Slate Grey | ● Dove Grey |
| ● Duck Egg Blue | ● Linen White |
| ● Blossom Pink | ○ Alpine White |
| | ● Crimson Red |
| | ● Citrus Yellow |
| | ● Fresh Orange |
| | ● Marine Blue |

Originally commissioned by Roald Dahl Museum and Story Centre (in deference to the beloved Anglepoise® lamp that Dahl used in his writing hut), inspiration for the Original 1227™ Giant is part Carwardine, part fantasy.



Customise Custom colour & finish available

Custom colours also available, details & price on application. Additional Pendant cable lengths available on request.

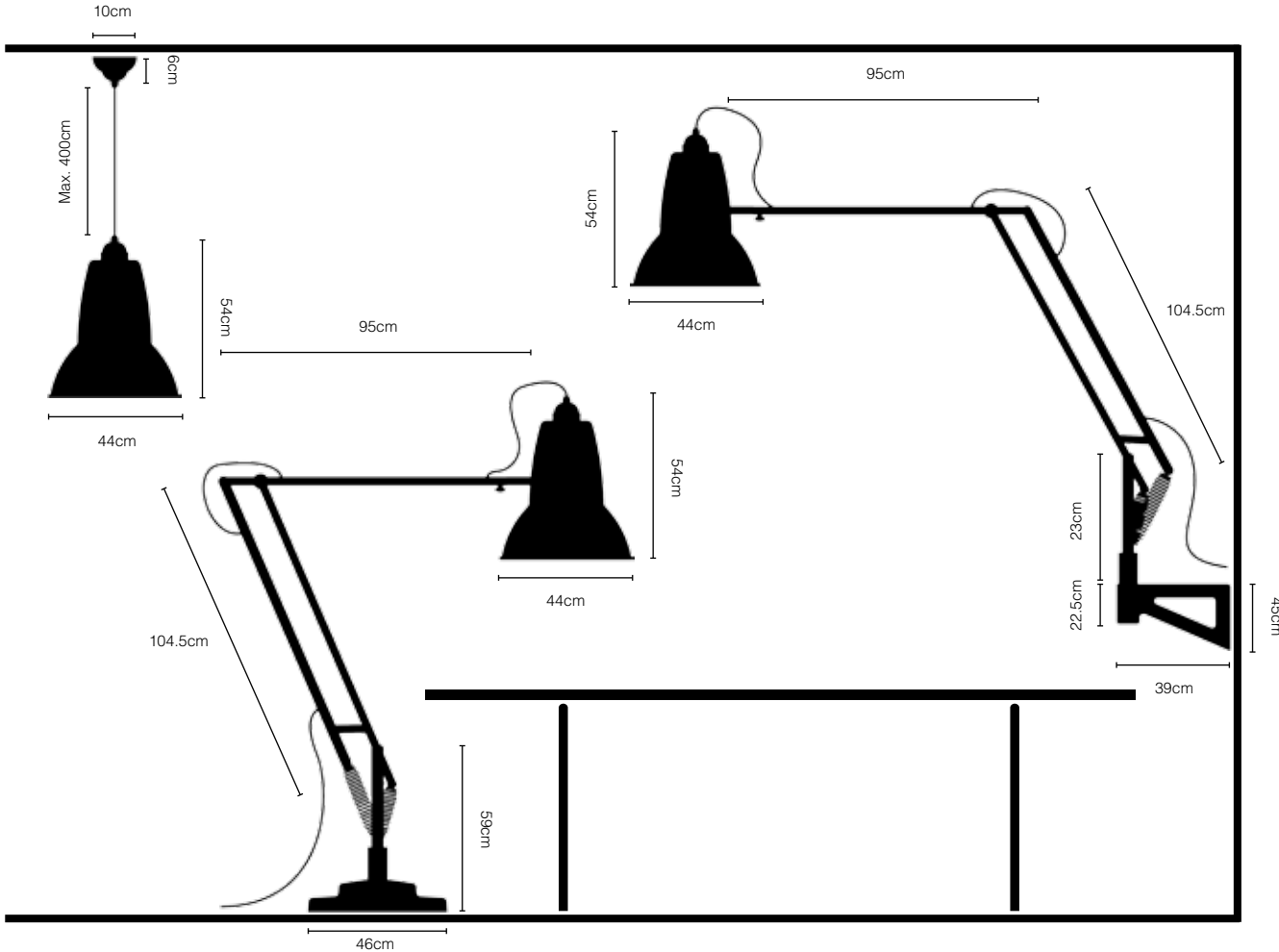

Original 1227™ Giant - Outdoor

Our tremendously successful and much loved Original 1227™ Giant range has been re-engineered for outdoor environments. Marine-grade stainless steel fittings combine with a sealed housing to enable the Giants to venture outdoors. Big enough to make a statement, but flexible enough to work in smaller areas too, both the floor lamp and articulated wall light help to bring the inside out, turning exterior spaces into striking al fresco rooms.



Customise
Custom colour &
finish available



IP65 Rated
Outdoor Suitable



Floor Lamp

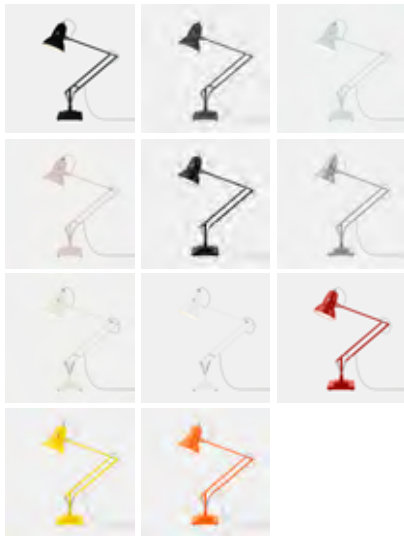
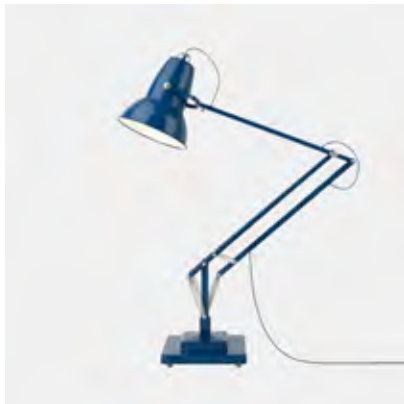

Wall Mounted Lamp



Available Colours:

Satin Finish

- Jet Black
- Slate Grey
- Duck Egg Blue
- Blossom Pink

Gloss Finish

- Jet Black
- Dove Grey
- Linen White
- Alpine White
- Crimson Red
- Citrus Yellow
- Fresh Orange
- Marine Blue

Anglepoise® classic blend of form and function, together with marine-grade stainless steel fittings and knurled bespoke adjuster wheels, sealed light unit and durable silicone rubber cable, make the Original 1227™ Giant Outdoor collection the perfect exterior lighting solution.



Custom colours also available, details & price on application. Additional Pendant cable lengths available on request.

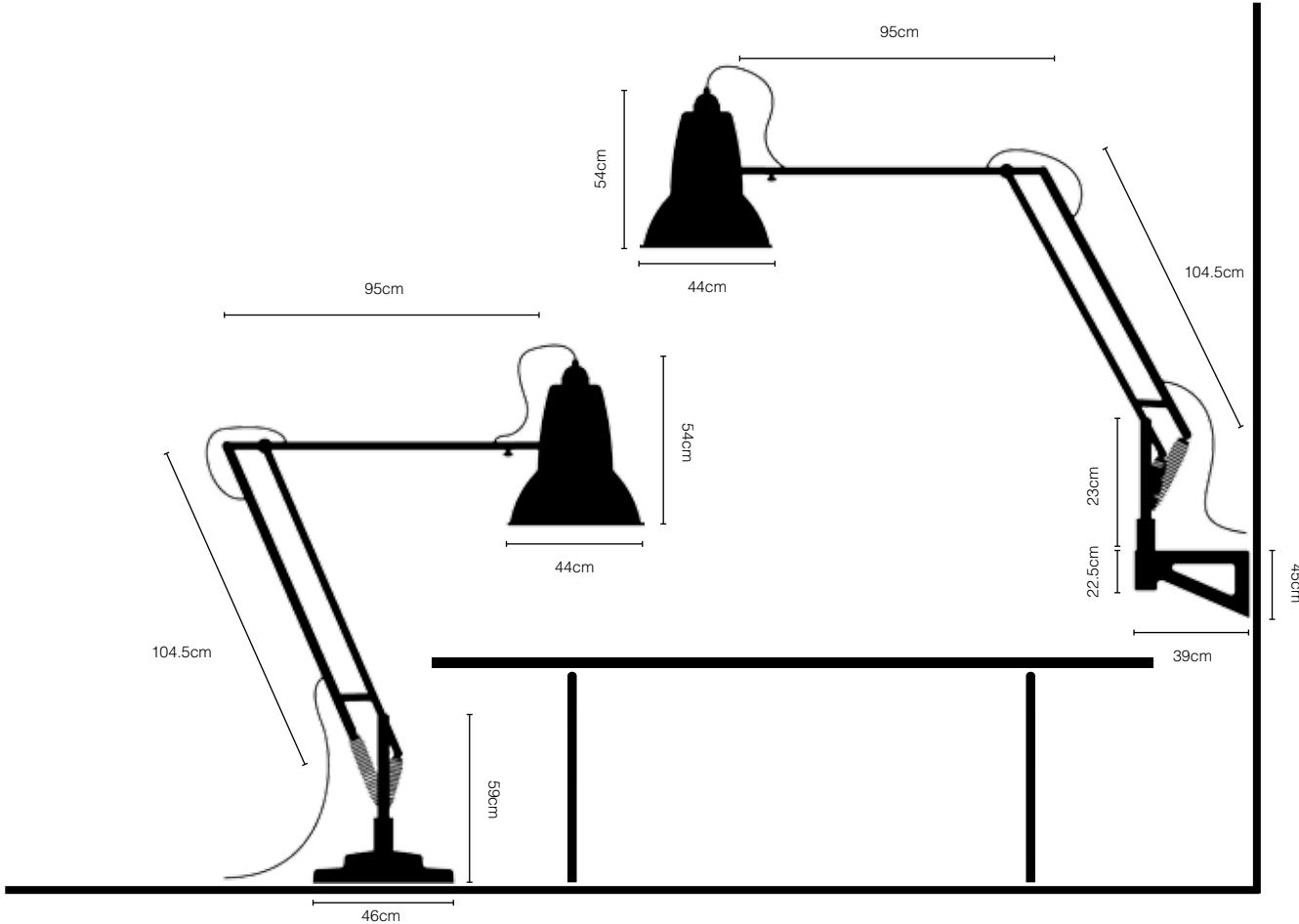



A super-sized version of the Original 1227™ Brass, our new Brass Giant Collection is a real showstopper. High end details such as finely crafted, solid brass components and fabric-covered cable create a luxurious aesthetic across the range (which consists of a floor lamp, wall mounted light and pendant), while the solid brass block on both the floor and wall lamps is a serious feature in its own right. Built to last, these are investment pieces; beautiful additions to the Anglepoise® family.



Customise
Custom colour &
finish available



Floor Lamp

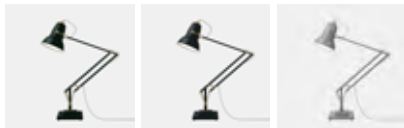

Wall Mounted Lamp

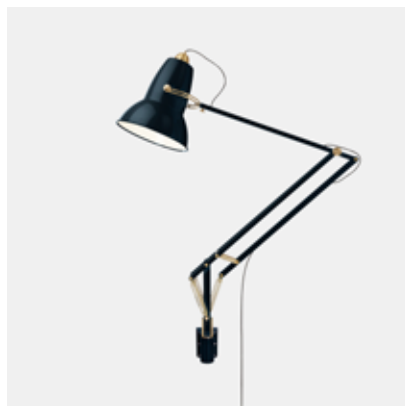

Pendant

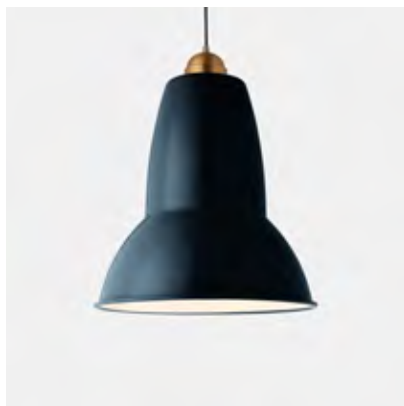

Available Colours:

- Ink Blue
- Midnight Green
- Deep Slate
- Elephant Grey
- Dusty Blue

High end details such as the finely crafted brass components – which include a stunning block machined out of solid brass - and fabric-covered cables create a luxurious aesthetic, while the engraved bespoke adjuster wheels make it easy to move about, despite its super-size proportions.



Customise
Custom colour &
finish available

Custom colours also available, details & price on application.
Additional Pendant cable lengths available on request.

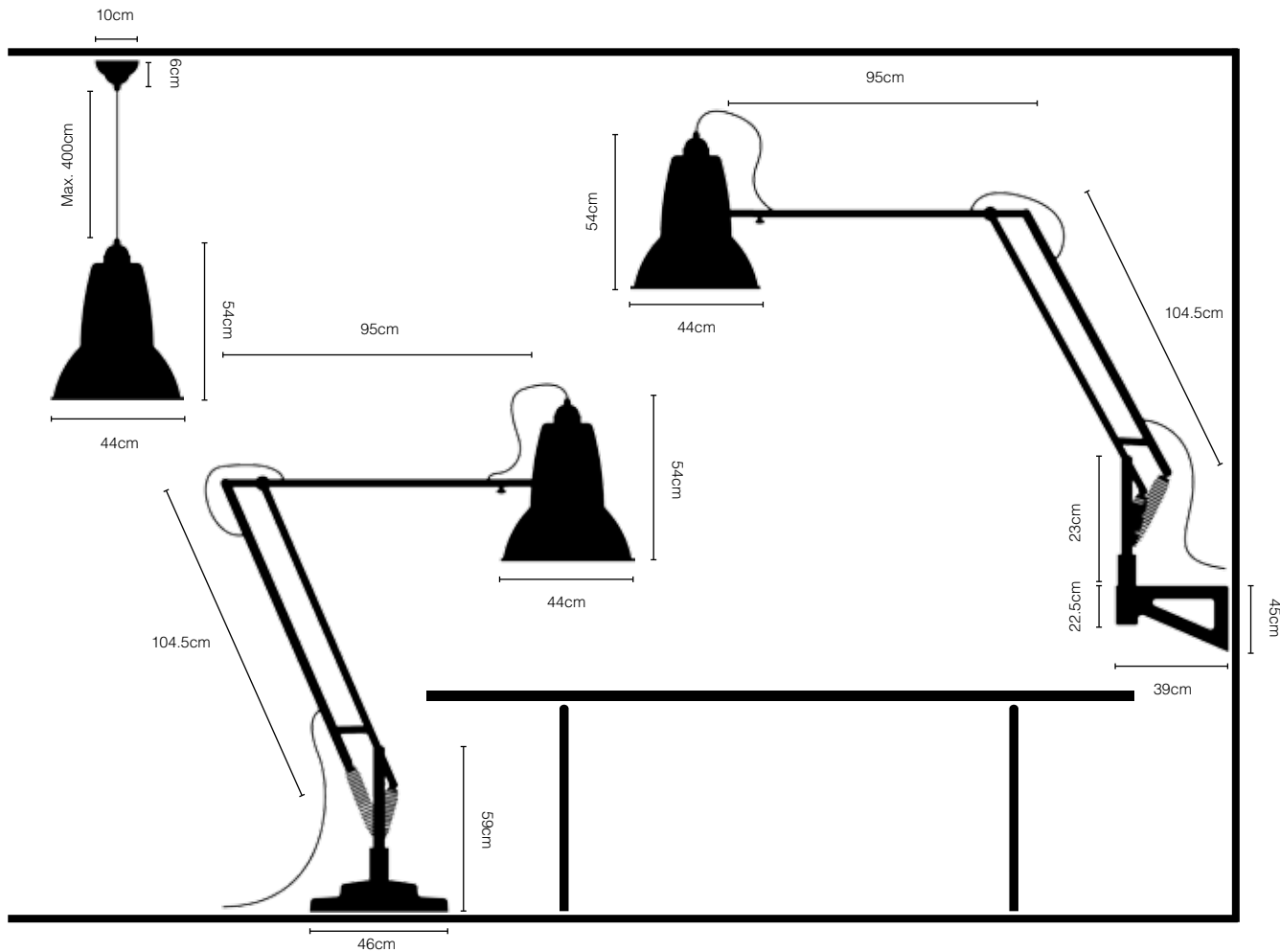



Sir Kenneth Grange's Type 75™ Mini collection offers all the functionality of its larger sibling, but in a more compact and colourful form, making it a popular choice for smaller spaces. The desk and wall mounted lamps incorporate Anglepoise® constant tension spring technology for matchless flexibility and perfect balance. They are complemented by a neat and versatile wall lamp.



Desk Lamp



Wall Mounted Lamp



Wall Light



Available Colours:

- Jet Black
- Slate Grey
- Alpine White
- Powder Blue (Desk Lamp only)
- Signal Red (Desk Lamp only)

With its diminutive size and smart satin finish, the Type 75™ Mini series is a joy to use, offering all the functionality of the Type 75™, presented in a more compact and colourful form.

Desk Lamp with Insert

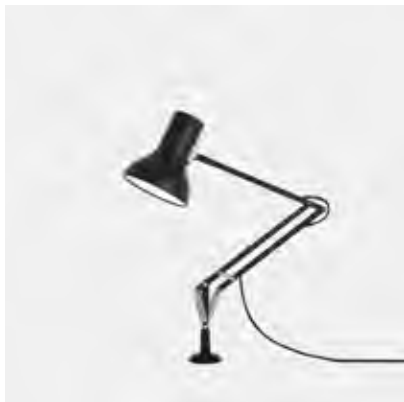

Desk Lamp with Clamp

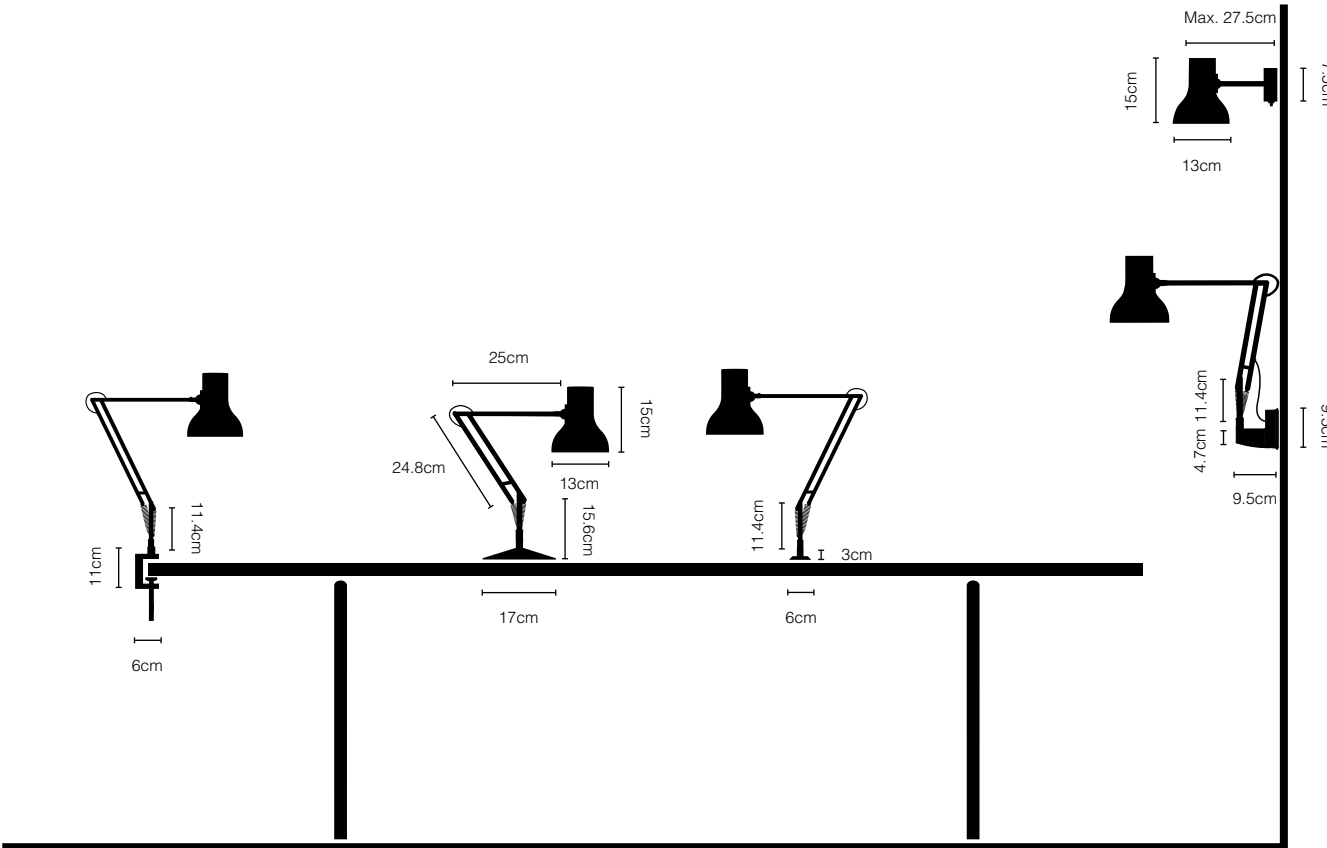

With its clean lines, flowing movement and flawless balance, Sir Kenneth Grange's Type 75™ reinterprets the original Anglepoise® design for the 21st Century. The pared-back aesthetic means that this six-piece range is at home anywhere, from hotel to home office; a fact that has helped to make the Type 75™ our bestselling collection across the globe.



Desk Lamp



Wall Mounted Lamp



Wall Light



Available Colors:

- Jet Black
- Jasmine White
- Brushed Aluminum

The smoothly-shaped shade, with its attractive stylised vents, can be moved into multiple positions, while the Anglepoise® unique constant tension spring mechanism guarantees that it will be a pleasure to use.

Floor Lamp



Desk Lamp with Clamp



Desk Lamp with Insert

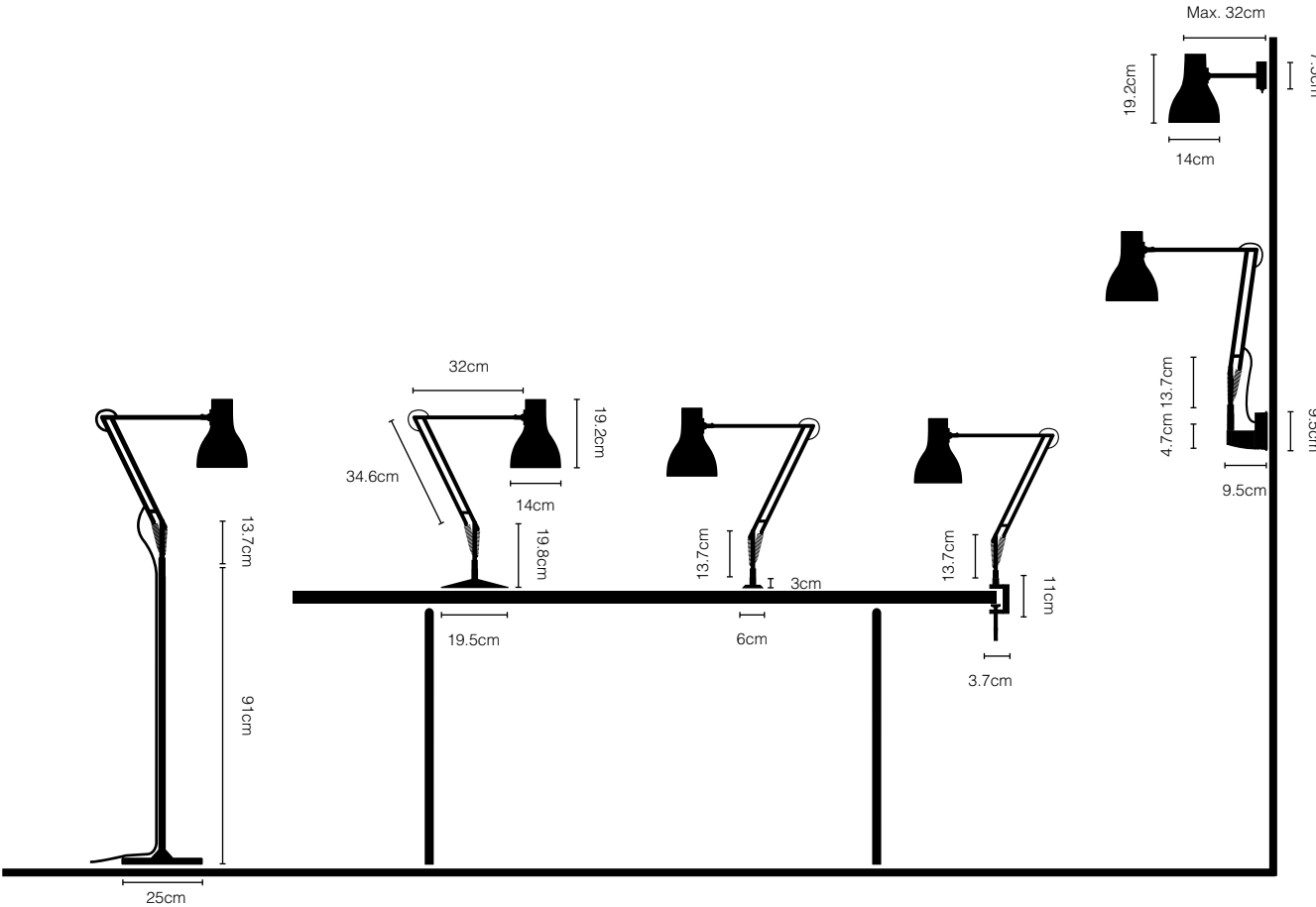

The Type Range is an Anglepoise® best seller and for 2017 we have re-designed and re-engineered the corresponding accessories collection so that it offers both professional and domestic users more flexible task lighting solutions than ever before.





Desk Insert

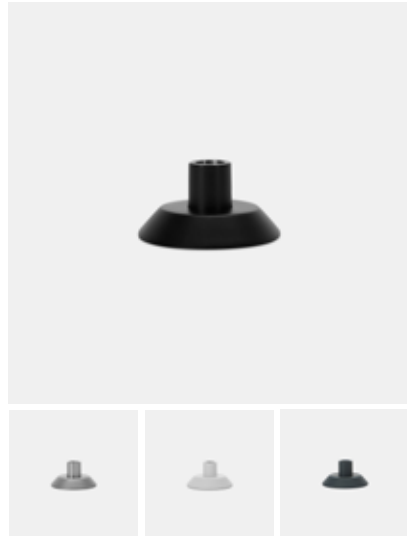

Wall Bracket



Desk Clamp



Available Colors:

- Jet Black
- Brushed Aluminium
- Alpine White
- Slate Grey

Our new Type Range Accessories extend the possible uses of our Type 75™, Type 75 Mini™ and Type 1228™ collections both on and off the desk. Alongside functional refinements such as a cable management option on the Wall Bracket and a more compact profile on the Desk Clamp, all four pieces now also have colour matched finishes for seamless integration with their corresponding products.

Floor Pole

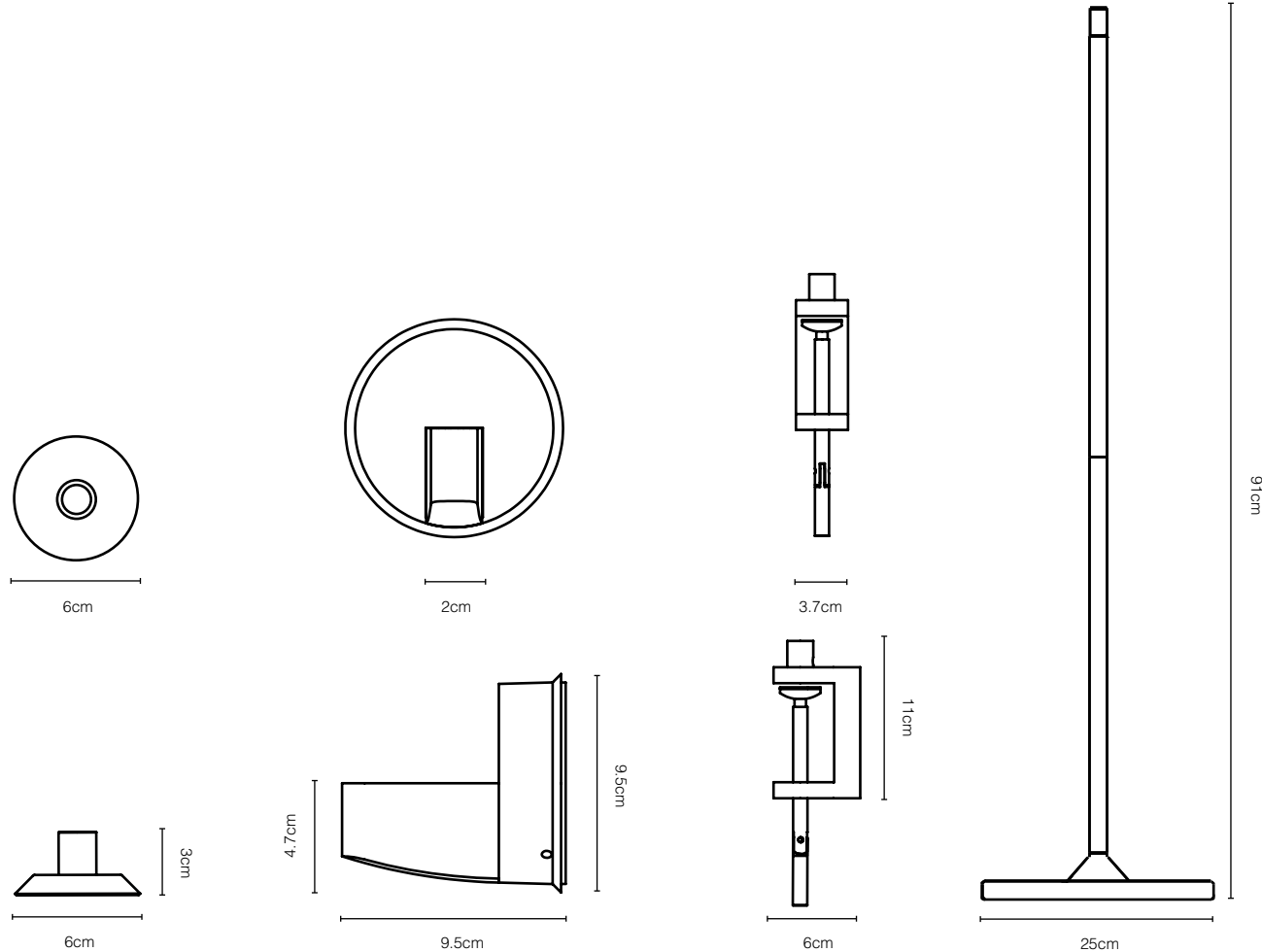
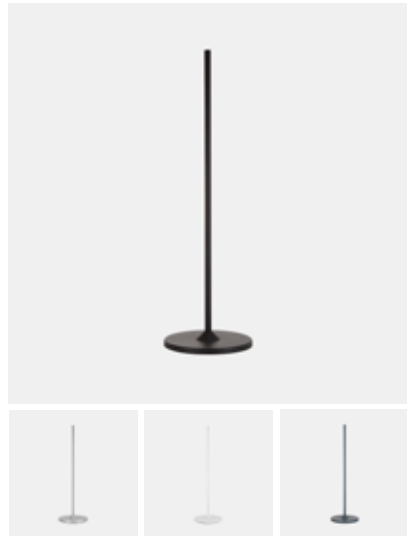

Type 75™ Maxi

The striking Type 75™ Maxi floor lamp has been beautifully engineered and built to exacting Anglepoise® standards, ensuring that this up-scaled version of Sir Kenneth Grange's bestselling design offers unrivalled adjustability, smooth movement, perfect balance and maximum stability. The bold shade shape is reflected in a coordinating Type 75™ Maxi pendant, with subtle metallic detail and stylish light escape feature.



Floor Lamp



Pendant

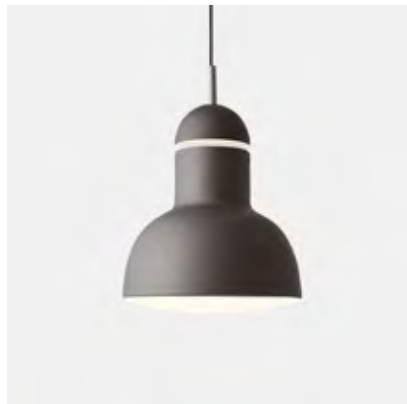

Available Colours:

- Jet Black
- Alpine White
- Graphite Grey

Beautifully engineered and built to exacting Anglepoise® standards, the striking Type 75™ Maxi collection combines smart, contemporary styling with superb performance.

Additional Pendant cable lengths available on request.

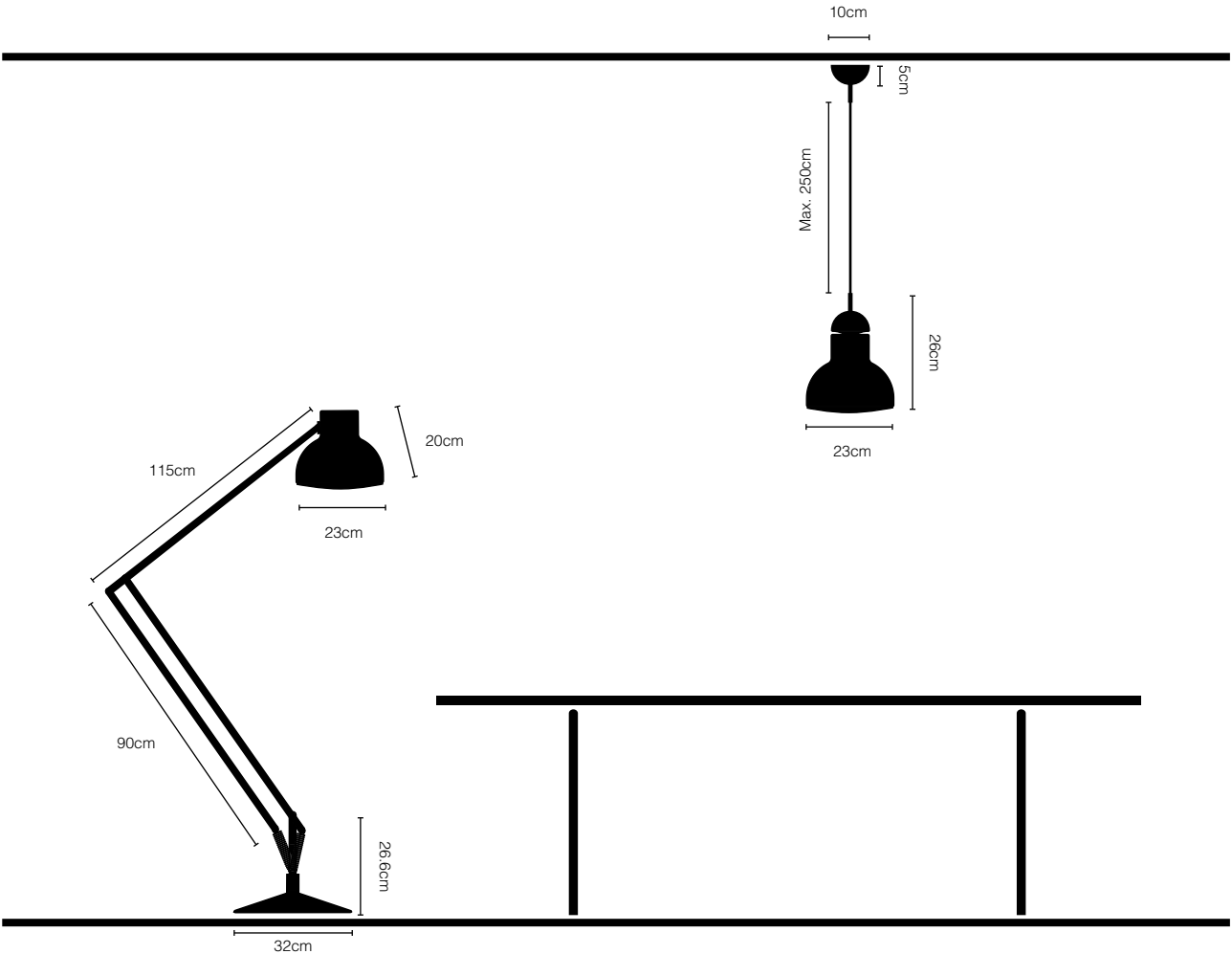

Type 75™ Giant

Three times the size of Sir Kenneth Grange's classic Type 75™ desk lamp, our Type 75™ Giant floor lamp is a striking, modernist alternative to the Original 1227™ Giant. Featuring precision machined components and a rotating shade, this is a statement piece that is as functional as it is beautiful.



RAL
Colour

Customise
Custom colour &
finish available

Floor Lamp

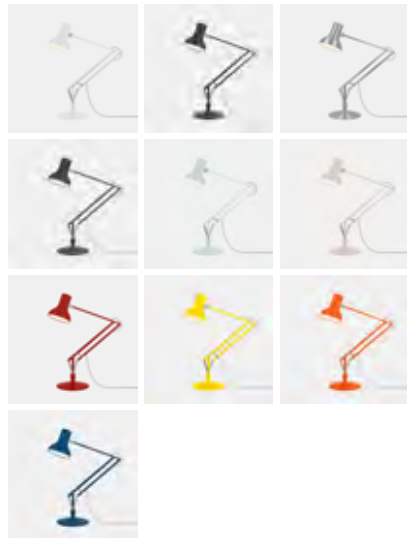

Available Colours:

- Jet Black
- Alpine White
- Graphite Grey
- Brushed Aluminium
- Slate Grey
- Duck Egg Blue
- Blossom Pink
- Crimson Red
- Citrus Yellow
- Fresh Orange
- Marine Blue

Designed by Sir Kenneth Grange, our Type 75™ Giant floor lamp is a striking, modernist alternative to the Original 1227™ Giant.



Customise
Custom colour &
finish available

Custom colours also available, details & price on application.

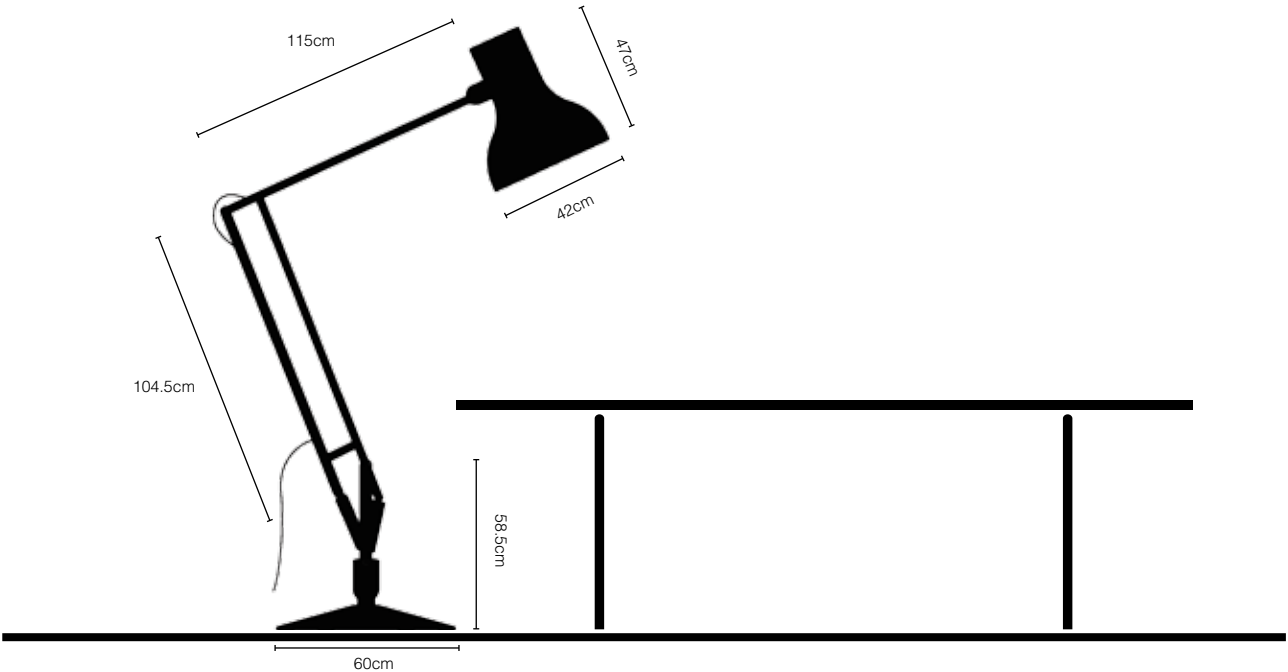

Maximum Reach

Images are not to scale.

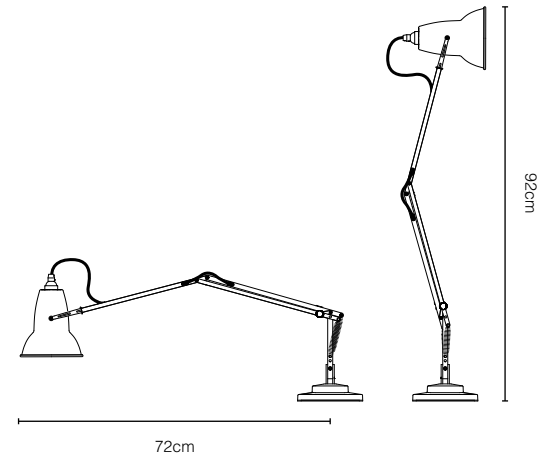

Original 1227™ Desk Lamp
Original 1227™ Brass Desk Lamp

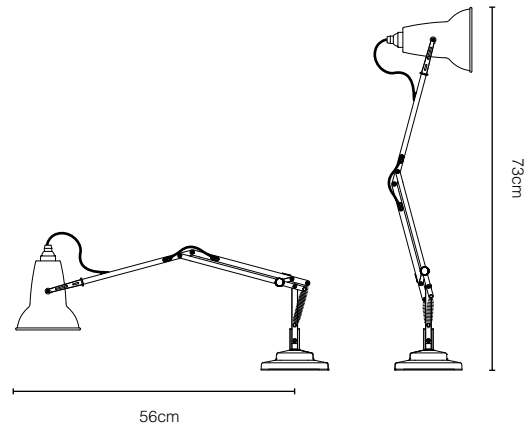

Original 1227™ Mini Desk Lamp

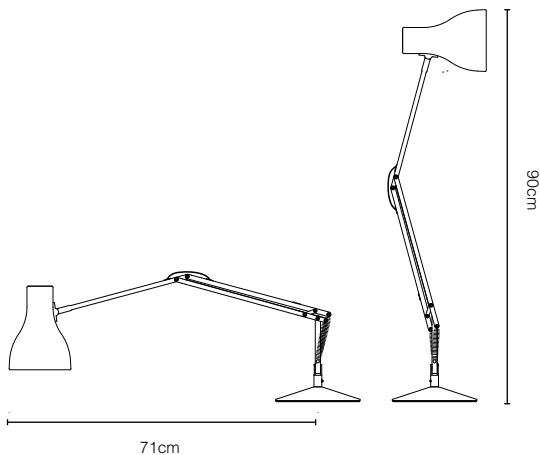

Type 75™ Desk Lamp

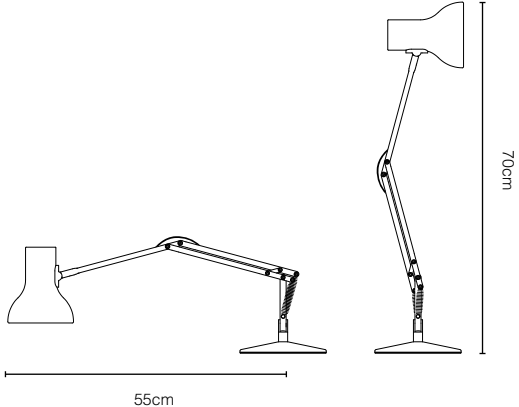

Type 75™ Mini Desk Lamp
Type 75™ Mini Metallic Desk Lamp

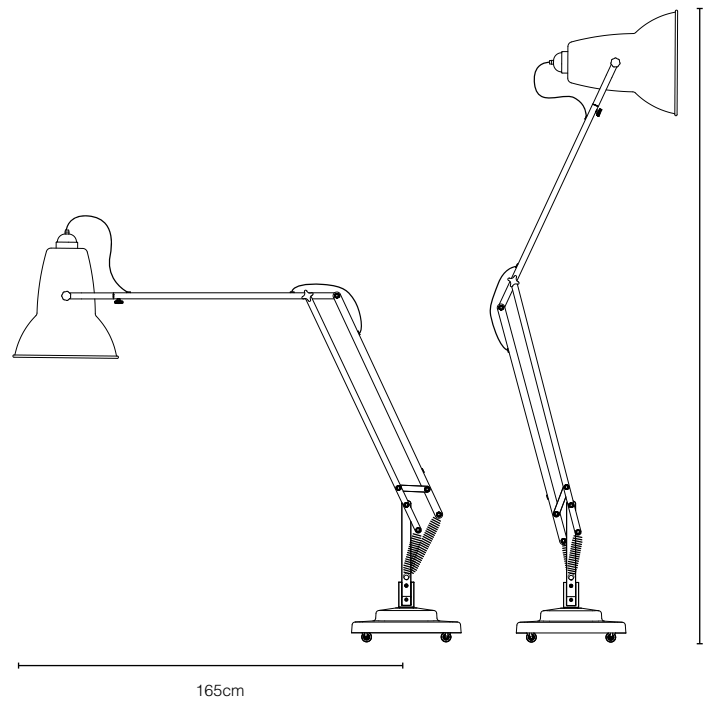

Original 1227™ Giant Floor Lamp
Original 1227™ Giant Brass Floor Lamp
Original 1227™ Giant Outdoor Floor Lamp

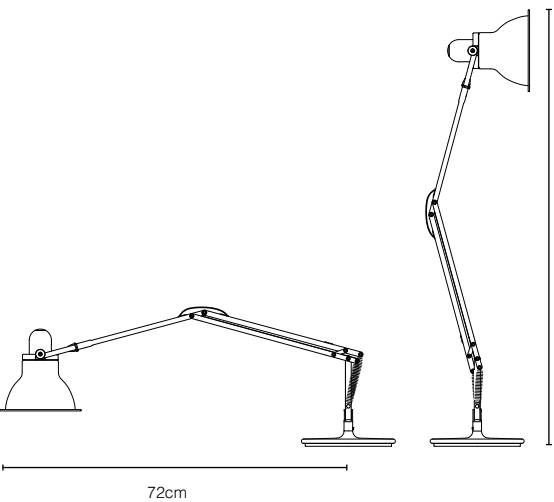

Type 1228™ Desk Lamp

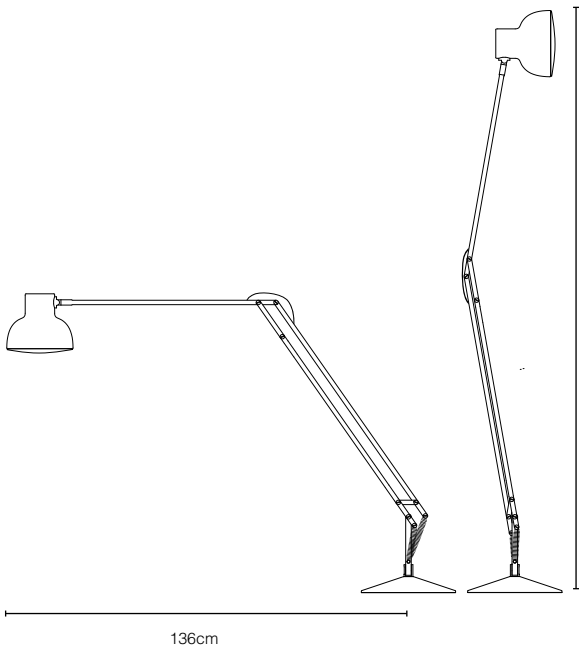

Type 75™ Maxi Floor Lamp

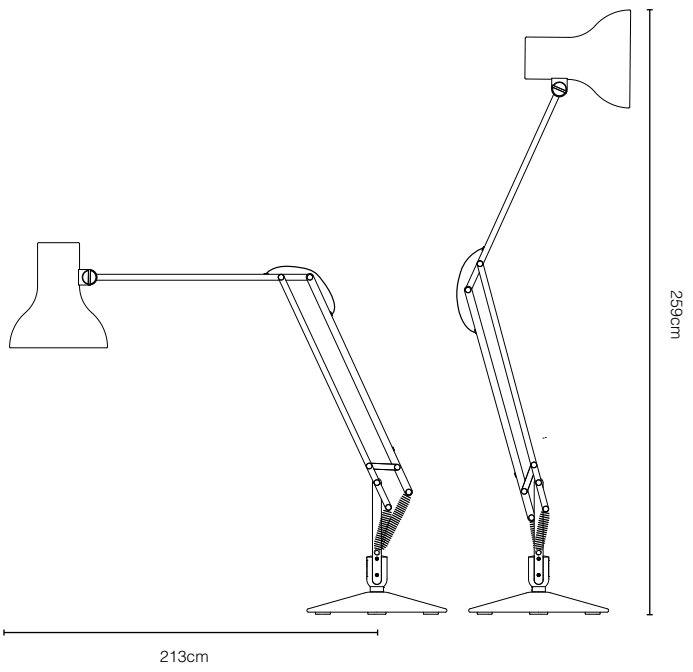

Type 75™ Giant Floor Lamp

Perfect Balance Mechanism

Images are not to scale.

Our Services

Albion Clerkenwell
Clear Law
Vega House
The Office Group
The Student Hotel
Prodigy Living



Anglepoise® Projects offers an extended series of premium lighting collections for workspace, retail, hospitality, hotel and residential environments around the world. Recent clients include Google, Spotify, LinkedIn, Soho House Group, Accor Hotels, Bentley Motors, HMV, Aesop, TfL, BFI and The Office Group.

We have offices in the UK, US and in Asia, and are sold in over 50 countries, providing local fulfilment and servicing through our offices, distribution hubs and partners.

Photography, brand assets, 3D files, photometric data and technical specifications for all of our products are available. We can also provide specific technical information and offer bespoke design capabilities - please get in touch if you would like more information.

Anglepoise® can support your project by offering:

- Dedicated customer support
- Local stockholding for short lead times
- Industry competitive pricing
- Customised design capabilities
- Custom colour options (MOQ 300)
- Accessible tech spec and trade library
- 2D and 3D CAD files
- Proactive intellectual property protection
- International roll out experience
- Integrated desk / wall fixtures and fittings

projects@anglepoise.com
www.anglepoise.com/project

Albion Clerkenwell

London, UK

Design by Prescott & Conran in
association with Isabelle Chatel de
Brancion from Spin Architecture

Photography by Paul Raeside

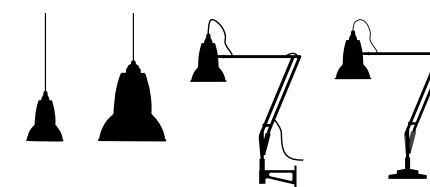

Clear Law, Timber Wharf

Manchester, UK

Creative Direction by Claire Brooker at
Chalkspace, Project Design & Build
by Ferrius

Graphic Identity, Vinyl Application &
Bespoke Pattern Design by Field

Photography by Helena Marie Dolby

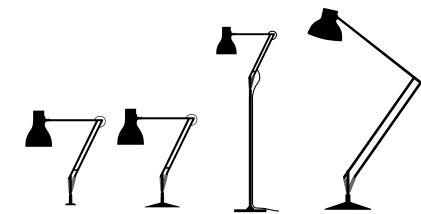



Vega House

Kagoshima, Japan

Photography by Ikunori Yamamoto



The Office Group

London, UK

The Smiths Building

Architecture by Stiff & Trevillion





The Student Hotel

Amsterdam, Netherlands

Design by ...,staat

Photography by Kasia Gatkowska

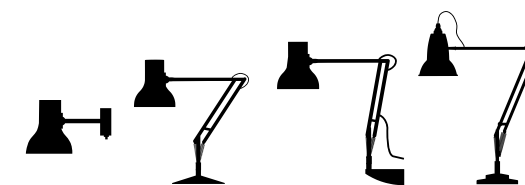

Prodigy Living

Manchester, UK

Wilmslow Park House

Interior Design by Seventyfour Architects

Procurement & Fit-Out by Preferred Spaces

Photography by Gu-Photography

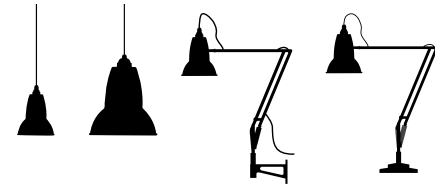

This at-a-glance index itemises the full Anglepoise® product range, grouped by category: Table, Wall, Ceiling and Floor.

Full collection details can be found on the page listed beneath each photograph.



Please note that the product images do not represent all available colours.



Original 1227™ Mini Desk Lamp
Page 42



Original 1227™ Desk Lamp
Page 46



Original 1227™ Brass Desk Lamp
Page 52



Type 75™ Desk Lamp - Margaret
Howell - Yellow Ochre Edition
Page 38

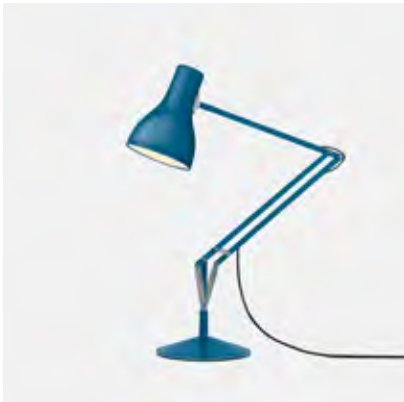

Type 75™ Desk Lamp - Margaret
Howell - Saxon Blue Edition
Page 38



Type 75™ Desk Lamp - Margaret
Howell - Seagrass Edition
Page 38

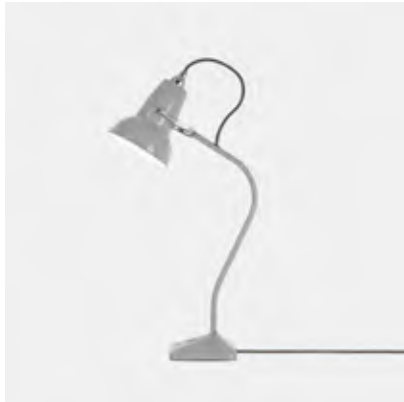

Original 1227™ Mini Table Lamp
Page 42



Original 1227™ Mini Ceramic
Table Lamp
Page 16



Type 1228™ Desk Lamp
Page 30



Type 75™ Desk Lamp - Paul Smith -
Edition One
Page 36



Type 75™ Desk Lamp - Paul Smith -
Edition Two
Page 36



Type 75™ Desk Lamp - Paul Smith -
Edition Three
Page 36

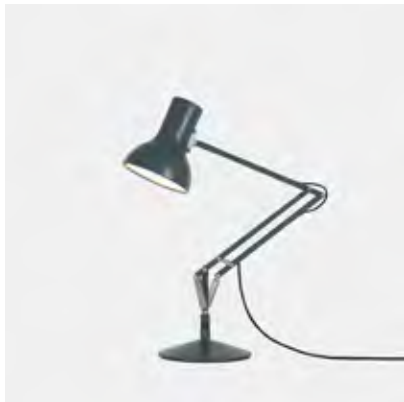

Type 75™ Mini Desk Lamp
Page 74

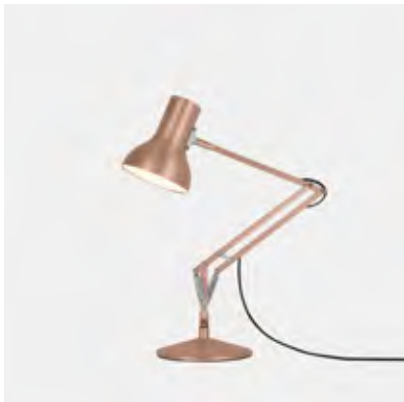

Type 75™ Mini Metallic Desk Lamp
Page 20



Type 75™ Desk Lamp
Page 78



Type 1228™ Desk Lamp with Clamp
Page 30



Type 75™ Mini Desk Lamp with
Clamp
Page 74



Type 75™ Desk Lamp with Clamp
Page 78

Please note that the product images do not represent all available colours.

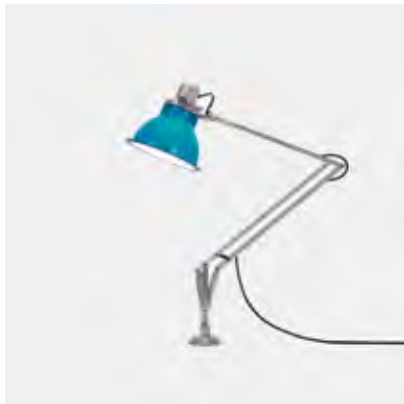

Type 1228™ Desk Lamp with Insert
Page 30

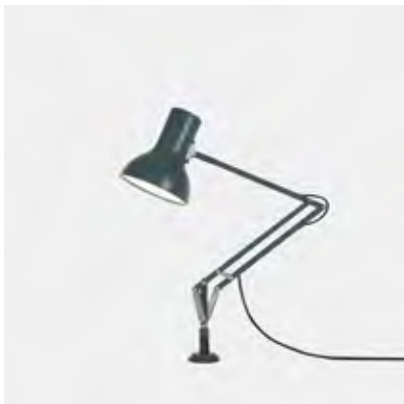

Type 75™ Mini Desk Lamp with Insert
Page 74



Type 75™ Desk Lamp with Insert
Page 78

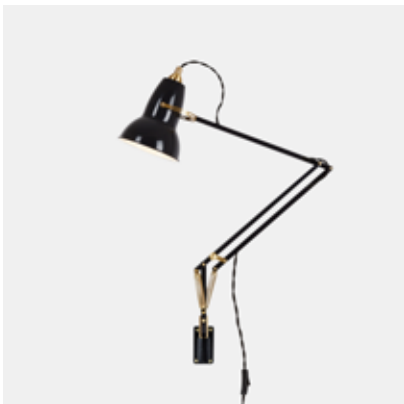

Original 1227™ Brass Desk Lamp
Page 52

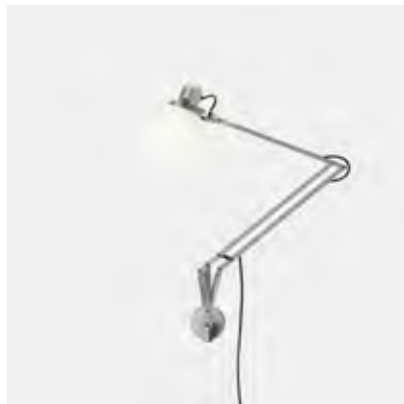

Type 1228™ Wall Mounted Lamp
Page 30



Type 75™ Mini Wall Mounted Lamp
Page 74

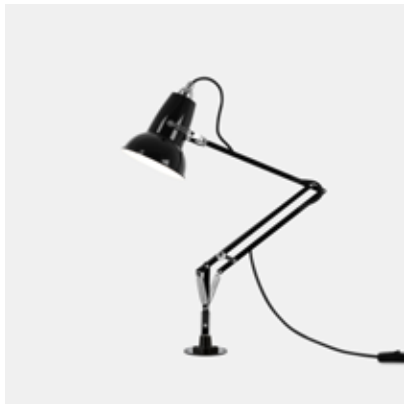

Original 1227™ Mini Desk Lamp with Insert
Page 42



Original 1227™ Desk Lamp with Insert
Page 46



Original 1227™ Mini Desk Lamp with Clamp
Page 42



Type 75™ Wall Mounted Lamp
Page 78



Original 1227™ Giant Wall Mounted Lamp
Page 62



Original 1227™ Giant Outdoor Wall Mounted Lamp
Page 66



Original 1227™ Desk Lamp with Clamp
Page 46

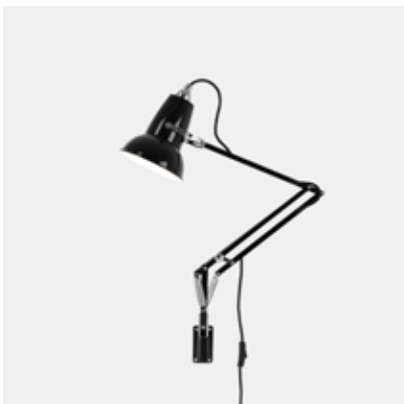

Original 1227™ Mini Wall Mounted Lamp
Page 42



Original 1227™ Wall Mounted Lamp
Page 46

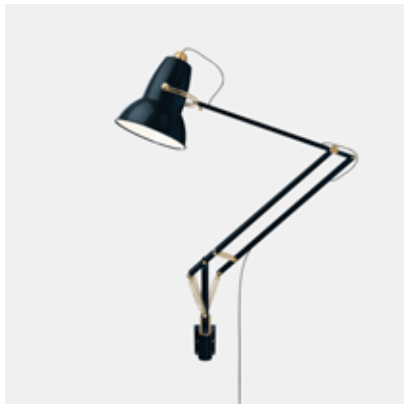

Original 1227™ Giant Brass Wall Mounted Lamp
Page 70

Please note that the product images do not represent all available colours.



Original 1227™ Giant Floor Lamp
Page 62



Original 1227™ Giant Outdoor Floor Lamp
Page 66



Original 1227™ Giant Brass Floor Lamp
Page 70



Original 1227™ Mini Ceramic Pendant
Page 16



Original 1227™ Pendant
Page 46



Original 1227™ Brass Pendant
Page 52



Type 75™ Maxi Floor Lamp
Page 88

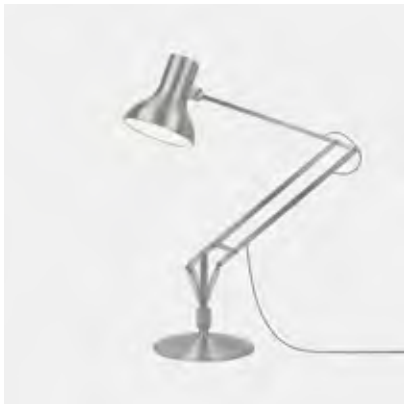

Type 75™ Giant Floor Lamp
Page 92



Original 1227™ Floor Lamp
Page 46

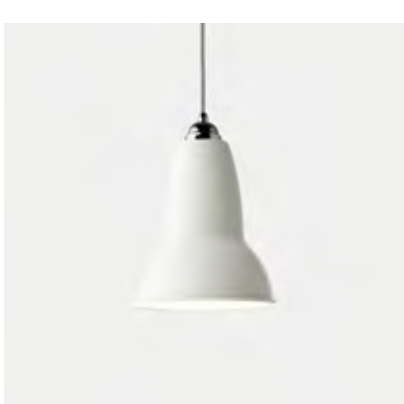

Original 1227™ Midi Pendant
Page 46

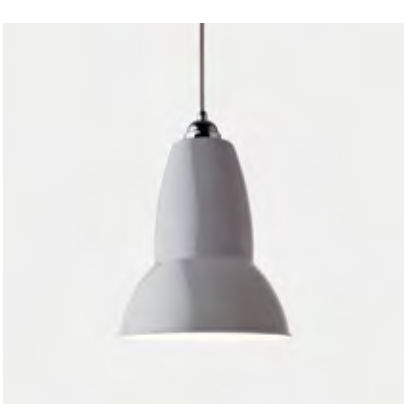

Original 1227™ Maxi Pendant
Page 46

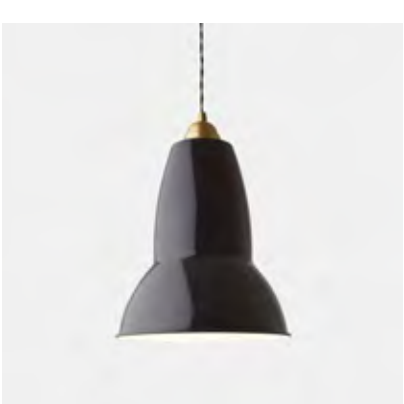

Original 1227™ Brass Maxi Pendant
Page 52



Type 1228™ Floor Lamp
Page 30



Type 75™ Floor Lamp
Page 78



Type 75™ Maxi Pendant
Page 88



Original 1227™ Mini Ceramic Pendant Cluster
Page 16



Original 1227™ Giant Pendant
Page 62



Original 1227™ Giant Brass Pendant
Page 70

Product Index

Please note that the product images do not represent all available colours.



Original 1227™ Mini Wall Light
Page 42



Original 1227™ Mini Ceramic
Wall Light
Page 16



Original 1227™ Wall Light
Page 46

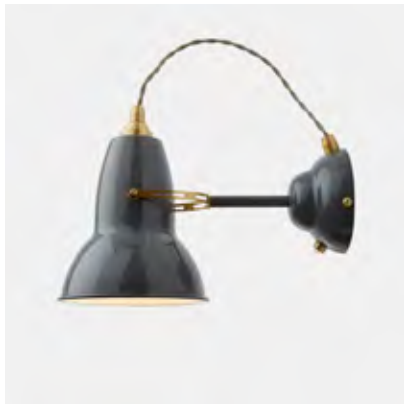

Original 1227™ Brass Wall Light
Page 52



Type 1228™ Wall Light
Page 30



Type 1228™ Metallic Wall Light
Page 26



Type 75™ Mini Wall Light
Page 74

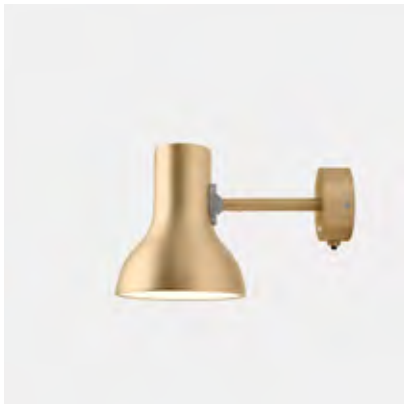

Type 75™ Mini Metallic Wall Light
Page 20



Type 75™ Wall Light
Page 78

Credits

Photography

Cyanotype Print by Russell Squires. Page 8.

Roald Dahl Photo by Jan Baldwin. Page 9.

Sir Kenneth Grange illustration. Designed & illustrated by Tom Rowe. Commissioned by The Design Museum for the Kenneth Grange Retrospective. Page 9.

Paul Smith Portrait by James Mooney. Page 9.

Photos by Jake Curtis, Stylist Hannah Simmons. Pages 2-3, 46, 50, 56, 62, 66, 70, 92, 114-115.

Photos by Anders Schonemann, Stylist Nathalie Schwer, for Cereal Magazine. Pages 4-5, 78.

Photos by Damian Russell, Stylist Suzanne Stankus. Pages 14-16, 20, 22-23, 26, 30, 58-59, 84-85.

Photos by Jake Curtis, Stylist Despina Curtis. Pages 34-35, 36, 38, 42, 52, 88.

Photos by Martin Gardner, Stylist Emma Hooton. Pages 74, 82.

Anglepoise at Euroluce 2015, presented by Cereal Magazine. Photo by Rich Stapleton, Stylist Nathalie Schwer. Pages 100-101.

hello@anglepoise.com
press@anglepoise.com
www.anglepoise.com
@Anglepoise



With thanks to Darkroom, Hay and Triangle for the loan of accessories and to Mud Australia for ceramic vessels.

Page		Furniture
4	Gubi Frederika Furniture	Grossman Desk '62 Series' Chair
22	Hay Beton Brut	Marble and Glass Boxes 't Spectrum Sofa by Martin Visser NL 1950
	Another Country	'Corrugated Dorset Series' Print by Richard Stapleton
26	Another Country	'Dorset Series' Postcards Small Pewter Plate by Ian McIntyre
34	Vitra Vitra	Compas Direction Desk Tabouret Solvay Stool
46	Knoll	Black Bertoia Side Chair
50	Knoll	Nakashima Walnut Straight Chair
	Gram Fratesi	TS Table
52	Benchmark Benchmark Vitra	Victoria Dining Table Victoria Bench Wire DKW Chair
56	Another Brand Imogen Heath Mud	Cubo Side Table - 1 Door Viaduct Cushion Ceramics
62	Another Brand	Cubo Wood Bench
66	twentytwentyone	Tio Outdoor Table & Chairs
70	Another Country Knoll	Desk Three & Accessories Bertoia Side Chair
74	Pinch	Lyle Console
78	Bon Marche	Drinks Cart by Christoph de la Fontaine
	Hay	Marble Box and Carafe
82	Modus	Angle Sofa
84	Surface View	'White Rocks Penninis' Print by Fay Godwin
	Another Country	Black Bench One
	Another Country	Terracotta Pitcher
	Beton Brut	Friso Kramer Revolt Chair by Ahrend de Cirkel
88	House Doctor	Marble Bowl
92	Knoll	Risom Lounge Chair
114	Another Brand	Cubo Rectangular Table Oak and Petrol Blue Cubo Dining Chair Oak Finish
	Another Brand	