

Top<sup>®</sup>  
Light

# Main Catalog

The People's Light



Design by<sup>®</sup>

**R**  
**Z**  
Rolf Ziel



Design by®



Rolf Ziel

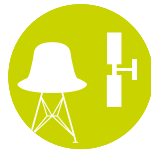

## Sehr geehrte Top Light Kunden,

als Hersteller von Designer Leuchten »Made in Germany«, freuen wir uns Ihnen heute den neuen Hauptkatalog 2015 »Main Catalog – The People's Light« vorstellen zu dürfen.

Lichtdesign von Rolf Ziel ist viel mehr als nur Licht!  
Es ist »Design for living and for life!«.

Fast alles ist möglich:

Dynamische Lichtobjekte werden zum strahlenden Mittelpunkt. Licht und Raum verschmelzen und glänzen im Zentrum der Wohn- und Objektmanege. Leuchten als praktische Alltagshelfer – für alle Lichthanforderungen im Gewerbe- und Privatbereich.

Auf 276 Seiten finden Sie unsere wahren Alleskönner in Sachen Lichtmöglichkeiten. Setzen Sie Akzente im Leuchtenzirkus! Bleiben Sie begeistert und anspruchsvoll.

Wir wünschen Ihnen viele »lichte Momente« mit dieser Ausgabe.

Viel Freude dabei.  
Herzlichst Ihr

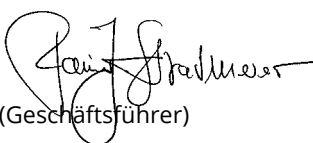
 + **Team**  
(Geschäftsführer)

## Dear Top Light Customers,

as a manufacturer of designer lamps "Made in Germany", we look forward to present you today the new main catalog 2015 »Main Catalog – The People's Light«.

Lighting design by Rolf Ziel is much more than just light!  
It is »Design for living and for life!«.

Nearly everything is possible:

Dynamic light objects are in the bright focus. Light and space merge and shine in the center of a residential and commercial arena. Lamps as practical everyday helpers – for all lighting requirements in the commercial and residential area.

On 276 pages you will find our full range of lighting. Put an accent with illumination! Stay enthusiastic and ambitious.

We wish you many »light moments« with this issue.

Enjoy reading.  
Best regards,

 + **Team**  
(business manager)

Top Light e. K.  
 Industriezentrum 100  
 32139 Spenge

fon +49 (0) 52 25 . 8 63 12 - 0  
 fax +49 (0) 52 25 . 8 63 12 - 10  
 www.top-light.de  
 brief@top-light.de

## Bestellhinweise

### Bezugsquelle

Top Light Produkte sind ausschließlich über unsere Fachhandelspartner zu beziehen.

### Bestellungen/Lieferungen

Angebote sind freibleibend und werden nur durch unsere schriftliche Bestätigung unter Zugrundelegung unserer AGB wirksam. Mündliche Vereinbarungen bedürfen der schriftlichen Bestätigung.

### Inhalt

Die Firma Top Light behält sich technische Änderungen vor. Für die Richtigkeit von technischen Angaben sowie Farbabweichungen wird keine Gewähr übernommen.

### Produkte

Für viele Top Light Leuchten sind nationale und internationale Schutzrechte wie Patente, Gebrauchsmuster, Geschmacks- oder Markenrechte eingetragen.

Produktdesign: Rolf Ziel

## Order Information

### Source

Top Light products are only available through our qualified dealers.

### Orders/Deliveries

All quotes are without obligation and are binding only after our written order confirmation based upon our General Terms of Business. Verbal agreements must be confirmed in writing.

### Content

The firm Top Light reserves technical changes. No guarantee is given for the correctness of technical statements and differences in colors.

### Products

For many Top Light lamps national and international protection rights such as patents, utility patents, design patents or trademark rights are registered.

Product design: Rolf Ziel

## Icons:

Alle Leuchtmittel der Energieeffizienzklasse »C« lassen sich durch Leuchtmittel der Energieeffizienzklasse »A bis A++« ersetzen (LED-Retrofit im Handel erhältlich).

All bulbs of energy efficiency class "C" can be replaced with bulbs of energy efficiency class "A to A++" (LED-Retrofit available in stores).



Kennzeichnung zur Konformitätserklärung des Herstellers über die Einhaltung bestehender EG-Richtlinien.

Proof of manufacturer's conformity with existing European directives.



Dimmbar mit Standard-Phasenanschnittdimmer für Glühlampen.

Dimmable with standard leading edge dimmer for incandescent lamps.



IP (Ingress Protection), Schutzart-Klassifizierung IP20 = Geschützt gegen das Eindringen von festen Fremdkörpern > 12 mm.

IP (Ingress Protection), Protection classification IP20 = Protected against ingress by solid foreign objects > 12 mm.



Dimmbar mit Standard-Phasenabschnittdimmer für LED.

Dimmable with standard leading edge dimmer for LED.



Dimmbar mit Standard-Phasenabschnittdimmer für elektronische Transformatoren.

Dimmable with standard leading edge dimmer for electronic transformers.



Schutzklasse I: Leuchten mit Schutzleiteranschluss.

Protection class I: Lamps with earth conductor connection.



Vorschaltgerät ist mit 1- 10V-Steuergerät dimmbar.

Ballast is dimmable with a 1 - 10V control unit.



Schutzklasse II: Leuchten mit einer zusätzlichen oder verstärkten Schutzisolierung.

Protection class II: Lamps with additional or reinforced protective insulation.



Vorschaltgerät ist mit DALI-Steuergerät dimmbar.

Ballast is dimmable with a DALI control unit.



Schutzklasse III: Leuchten im Niedervoltbereich.

Protection class III: Lamps in low-voltage range.



Separater Lichtschalter am Leuchtengehäuse.

Separate light switch on lamp housing.



IP (Ingress Protection), Schutzart-Klassifizierung IP44 = Geschützt gegen das Eindringen von festen Fremdkörpern > 1 mm und gegen Spritzwasser aus allen Richtungen.

IP (Ingress Protection), Protection classification IP44 = Protected against ingress by solid foreign objects > 1 mm and against splashing water from any direction.



Elektronischer Transformator.

Electronic transformer.



Elektronisches Vorschaltgerät (EVG).

Electronic ballast.



Vorschaltgerät ist ausgelegt für zwei unterschiedliche Wattagen.

Ballast can operate two different wattages.

Für unsere LED Leuchten empfehlen wir folgende Dimmer:  
 For our LED lamps we recommend the following dimmer:

- Gira Tronic-Dimmer
- Busch-Jaeger LED Drehdimmer
- Jung Triac-Dimmer

In diesem Katalog gezeigte Farben sind ein Hinweis auf das optische Finish und keine Eigenschaftszusicherung. Für die Richtigkeit von technischen Angaben, sowie Farbabweichungen, wird keine Gewähr übernommen. Alle Maßangaben sind unverbindlich und können geringfügige Abweichungen aufweisen. Technische Änderungen vorbehalten!



# Die 9 Top Light Grundsätze

## The 9 main principles of Top Light

- ① Ihre absolute Zufriedenheit steht im Mittelpunkt all unserer Bemühungen.  
Fulfilling your wishes and your complete contentment is our main concern.
- ② Alle Team-Mitglieder sind ausgesuchte qualifizierte Fachkräfte, die stets ungezwungen und hilfsbereit für Sie da sind.  
All members of our team are selected and qualified specialists who are always there for you.
- ③ Ein hohes Maß an Qualität und ein optimales Verhältnis von Preis, Leistung und Vertrauen sind bei uns selbstverständlich.  
We assure you high degree of quality and an optimum relation of price, performance and reliance.
- ④ Innovativ: TOP LIGHT Produkte werden dem technischen Fortschritt ständig angepasst.  
Innovative: Top Light products are always adapted to technological progress.
- ⑤ Unser Entwicklungsteam bietet Ihnen individuelle Lösungen und spezifische Produkte.  
Our development team offers you individual solutions and products according to your demands.
- ⑥ Kunden-, bedarfs- und serviceorientierte Beratung wird bei uns groß geschrieben.  
Customer- and demand-oriented consulting matters greatly for us.
- ⑦ Auf schnelle und flexible Auftragsbearbeitung in einer zwanglosen Atmosphäre legen wir größten Wert.  
We gladly offer a quick and flexible order management.
- ⑧ Wir bieten Ihnen einen perfekten Rundum-Service an allen Werktagen im Jahr.  
We provide a perfect all-around service: all working days of year.
- ⑨ Für Anregungen und Kritik sind wir stets offen. Bitte rufen Sie uns an unter 0 52 25 . 8 63 12 - 0 oder senden Sie uns eine e-Mail an [feedback@top-light.de](mailto:feedback@top-light.de)  
Proposals and criticism are always welcome. Please call us under +49 (0) 52 25 . 8 63 12 - 0 or send us an e-mail: [feedback@top-light.de](mailto:feedback@top-light.de)





## Puk World (Puk Leuchten für jede Anwendung / Puk Lamps for each use) 08-125

Puk Wall & Wall »+«	16-19	Puk Floor Maxi	52-53	Puk Maxx Eye	94-95
Puk Fix & Fix »+«	20-21	Puk Floor Mother-Kid	54-55	Puk Maxx Table	96-97
Puk Mirror & Mirror »+«	22-23	Puk Flexlight	56-57	Puk Maxx Floor Mini	98-99
Puk One, Plus & Turn	24-27	Puk Equipment	58-59	Puk Maxx Floor Sister	100-101
Puk Side	28-31	Puk Maxx Wall & Wall »+«	62-65	Puk Maxx Floor Maxi	102-103
Puk Wing	32-35	Puk Maxx Fix & Fix »+«	66-67	Puk Maxx Floor Mother-Kid	104-105
Puk Long One & Double	36-37	Puk Maxx Mirror & Mirror »+«	68-69	Puk Maxx Equipment	106-107
Puk Ceiling Sister Twin	38-39	Puk Maxx Plus & Turn	70-73	Puk Meg Maxx Wall »+« & Plus	108-109
Puk Quartett & Sixtett	40-41	Puk Maxx Side & Wing	74-81	Puk Meg Maxx Equipment	110-111
Puk Mike	42-43	Puk Maxx Long One & Double	82-83	Puk Outdoor	114-115
Puk Eye	44-45	Puk Maxx Ceiling Sister Single	84-85	Puk Outdoor Equipment	116-117
Puk Table	46-47	Puk Maxx Bone	86-87	Puk Maxx Outdoor	118-119
Puk Floor Mini	48-49	Puk Maxx Quartett & Sixtett	88-89	Puk Maxx Outdoor Equipment	120-121
Puk Floor Sister	50-51	Puk Maxx Tri Star	90-91	Puk Meg Maxx Outdoor	122-123
		Puk Maxx Mike	92-93	Puk Meg Maxx OD Equipment	124-125



## Licht & Spiegel / Light & Mirrors (Spiegel mit integrierter Beleuchtung / Mirrors with integrated lighting) 128-171

Lichtspiegel Modellübersicht	132-135	SideLight	146-149	BulbLine	162-165
LED New Line	136-137	DotLight	150-153	Circle	166-167
Visagist	138-141	BrightLight	154-157	Vision	168-169
FineLine	142-145	InLight	158-161	Doppelwaschtisch	170
				Ornaments	171



## Badspiegelleuchten / Mirror Lamps for the Bath (für Spiegelan-, Spiegelauf- und Spiegeleinbau / Mirror Mounting) 172-187

BulbStripe	174-175	Hotline – EasySystem	180	Lens	192-195
Better	176-177	Lichtstange	181-183	Focus	196-201
Hotline	178-179	Two Socket	184-185	Flexlight Fix	240
		Puk Fix & Mirror (s. Puk World)	186	Glasslight Fix	248
				Spotlight Fix	251



## Wohnraum-, Bad- & Objekteuchten für die Wand / Living Room, Bath & Object Lamps for the Wall 190-207

Lens (Wand-, Spiegelklemm-, Spiegeleinbauleuchten)	192-195	Focus 100 (Wand-, Spiegelklemm-, Spiegeleinbauleuchten)	196-197	Lightboard	202-203
		Focus 150 (Wand-, Spiegelklemm-, Spiegeleinbauleuchten)	198-199	Cube	204-205
				Tube	206-207



## Wohnraum-, Bad- & Objekteuchten für die Decke / Living Room, Bath & Object Lamps for the Ceiling 208-225

Look at me	210-213	Ceiling Dela	219	Ceiling Quadro	222
Dela	214-217	Quadro	220	Ceiling	223
Dela Box	218	Quadro Box	221	Pela, Pela Quadro	224-225



## Baukastenleuchten / Modular Lamps (mit über 1.500 Variationen / with more than 1.500 Variations) 226-253

Ambiente	228-231	Light On	232-235	Glasslight	246-253
		Flexlight	236-245	Spotlight	246-253



## Living Outdoor Collection 256-273

Puk Outdoor (s. Puk World)	258-259	Lightstone Beton	264-265	Lightstone Lichtpunkt	270-271
Octopus Outdoor	260-261	Lightstone Basalt	266-267	Lightstone Rund	272
Lightstones Overview	262-263	Lightstone Cristal	268-269	Lightstone Norma H & S	272
				Technical accessories	273







# Puk World

»Puk World« heißt nicht nur die Serie für Indoor und Outdoor, sondern »World« ist auch Programm bei Top Light. Individualität und jede Anforderung der Ausleuchtung von Gewerbe, Objekt oder privaten Räumlichkeiten wird Rechnung getragen. Mit der Optionalität, Linsen, Gläser und Farbfilter beliebig einzusetzen, lässt sich jede Lichtsituation realisieren! Alternativ mit investitionssicheren LED oder Halogenbestückung.

»Puk World« is the series for indoor and outdoor lamps and offers you Top Light's whole variety of illumination. Individuality and every requirement of illumination for commercial or private objects is included. With the option to use lenses, glasses and color filters, you can realize every light situation! Alternatively with long living LED or halogen assembly.







Design by

*Ralf Diehl*

# Puk World – Main Overview

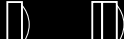
## Puk Wandleuchten / Wall lamps 16 – 35

					
Puk Wall 17 Puk Wall + 19	Puk Fix & 21 Puk Fix +	Puk Mirror & 23 Puk Mirror +	Puk One & 25 Plus	Puk 28 – 31 Side	Puk 32 – 35 Wing



## Puk Deckenleuchten / Ceiling lamps 24 – 39

				
Puk One & 25 Puk Plus	Puk Turn 27	Puk Side 28 – 31	Puk Wing 32 – 35	Puk Ceiling Sister Twin 39

## Puk Pendelleuchten / Pendant lamps 37 – 41

	
Puk Long One & 37 Puk Long Double	Puk Quartett & 41 Puk Sixtett







## Puk Tischleuchten / Table lamps 43 – 47

		
Puk Mike 43	Puk Eye Table 45	Puk Table 47

## Puk Stehleuchten / Floor lamps 43 – 55

				
Puk Mike 43	Puk Eye Floor 45	Puk Floor Mini 49 Puk Floor Maxi 53	Puk Floor Sister 51	Puk Floor 55 Mother-Kid

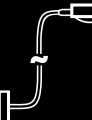
## Puk Flexlight 57 – 59

						
Puk Flexlight 57						Puk Equipment 59



## Puk Maxx Wandleuchten / Wall lamps 63 – 81



Puk Maxx Wall 63  
Puk Maxx Wall + 65



Puk Maxx Fix 67  
& Puk Maxx Fix +



Puk Maxx Mirror 69  
& Puk Maxx Mirror +



Puk Maxx 71  
Plus

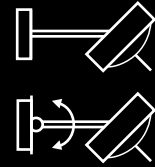

Puk Maxx Side 74 – 77  
Puk Maxx Wing 78 – 81

## Puk Maxx Deckenleuchten / Ceiling lamps 71 – 85



Puk Maxx 71  
Plus



Puk Maxx 73  
Turn



Puk Maxx 74 – 77  
Side



Puk Maxx 78 – 81  
Wing

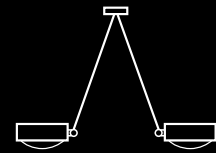

Puk Maxx Ceiling Sister 85

## Puk Maxx Pendelleuchten / Pendant lamps 83 – 91

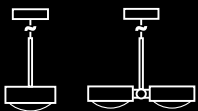

Puk Maxx 83  
Long One &  
Long Double

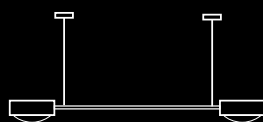

Puk Maxx Bone 87



Puk Maxx Quartett & 89  
Puk Maxx Sixtett

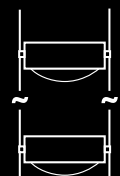

Puk Maxx 90 – 91  
Tri Star

## Puk Maxx Tischleuchten / Table lamps 93 – 97



Puk Maxx Mike 93



Puk Maxx 95  
Eye Table



Puk Maxx Table 97

# Puk World

## Puk Maxx Stehleuchten / Floor lamps 93 – 105



Puk Maxx 93  
Mike



Puk Maxx 95  
Eye Floor

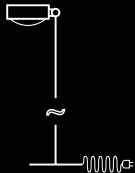

Puk Maxx Floor Mini 99  
Puk Maxx Floor Maxi 103

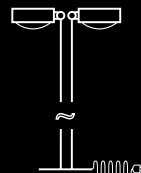

Puk Maxx Floor 101  
Sister

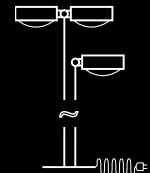

Puk Maxx Floor 105  
Mother-Kid

Puk Maxx Equipment 107

## Puk Meg Maxx Wand- & Deckenleuchte / Wall & ceiling lamp 108 – 111

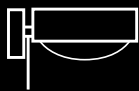

Puk Meg Maxx Wall 109



Puk Meg Maxx Plus 109

Puk Meg Maxx 111  
Equipment

## Puk Outdoor Wand- & Deckenleuchte / Wall & ceiling lamp 114 – 117



Puk Outdoor Wall 115



Puk Outdoor 115  
Plus & Turn

Puk Outdoor 117  
Equipment

## Puk Maxx Outdoor Wand- & Deckenleuchte / Wall & ceiling lamp 118 – 121



Puk Maxx Outdoor Wall 119



Puk Maxx Outdoor 119  
Plus & Turn

Puk Maxx Outdoor 121  
Equipment

## Puk Meg Maxx Outdoor Wand- & Deckenleuchte / Wall & ceiling lamp 122 – 125

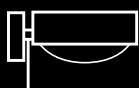

Puk Meg Maxx Outdoor Wall 123



Puk Meg Maxx Outdoor 123  
Plus

Puk Meg Maxx Outdoor 125  
Equipment



# Puk, Puk Maxx & Puk Meg Maxx

## Kopf-Konfigurationen Head configuration

Diese intelligente und moderne Leuchtenserie bietet Wand-, Decken-, Spiegel-, Pendel-, Steh- und Tischleuchten in verschiedenen Oberflächen. Auf dieser Seite sehen Sie die Möglichkeiten der Bestückung mit Linse, Glas, Lichtstopp und Farbfilter – egal ob Halogen oder LED.

This smart and modern lighting range offers wall, ceiling, mirror, pendula, floor and table lamps with various surfaces. On this page you see the possibilities of assembly with lens, glass, lightstop and color filter - no matter whether halogen or LED.



Puk Wall  
ø 80 mm

Puk Maxx Wall  
ø 120 mm

Puk Meg Maxx Wall  
ø 160 mm

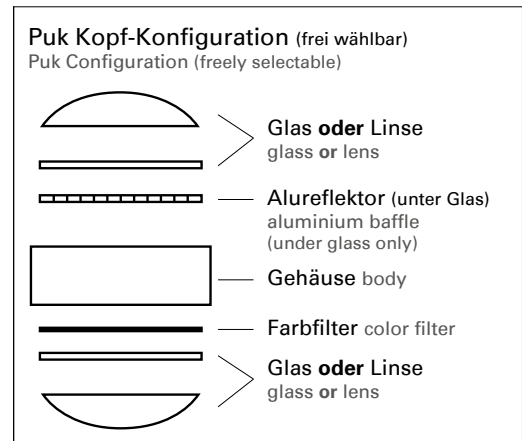

### Puk Wall Halogen: Kopf-Konfigurationen Head configuration



Lichtstopp/Glas  
lightstop/glass

Glas/Glas  
glass/glass

Lichtstopp/Linse  
lightstop/lens

Glas/Linse  
glass/lens

Linse/Linse  
lens/lens

### Puk Maxx Wall LED: Farbfilter Color Filter



Farbfilter rot  
color filter red

Farbfilter magenta  
color filter magenta

Farbfilter gelb  
color filter yellow

Farbfilter blau  
color filter blue

Farbfilter grün  
color filter green

# Puk, Puk Maxx & Puk Meg Maxx



Puk Meg Maxx Wall ø 160 mm, Puk Maxx Wall ø 120 mm & Puk Wall ø 80 mm

## Puk Wall: Oberflächen Surfaces

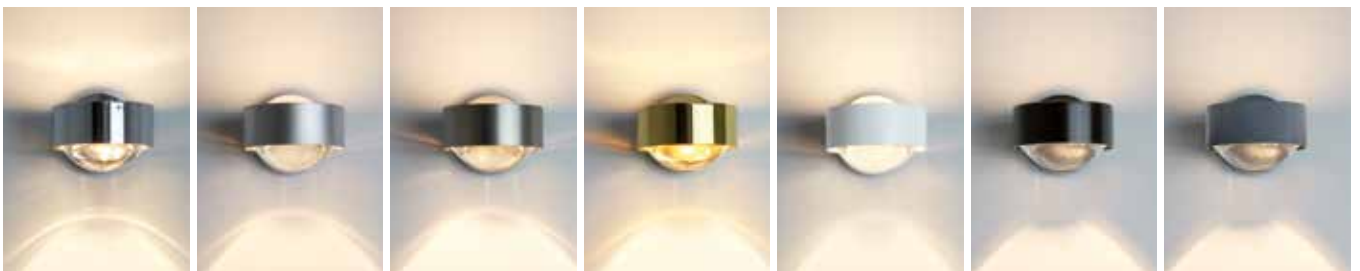

chrom  
chrome

chrommatt  
chrome matt

nickelmatt  
nickel matt

gold  
gold

weiß  
white

schwarz  
black

anthrazit  
anthracite



# Puk

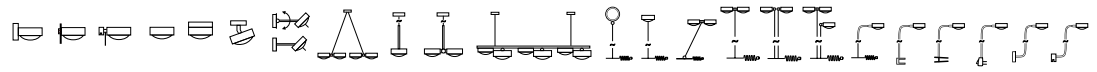

Puk Wall

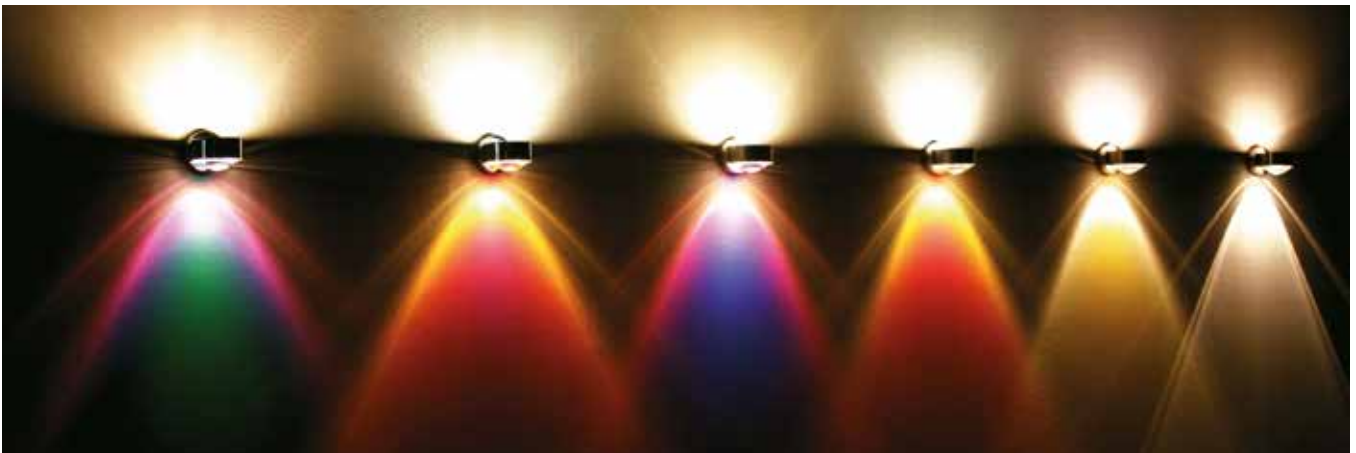

Puk Wall Farbfilter Colorfilter



Puk Floor Maxi Twin, Puk Table Single, Puk Wall



Puk Wall, chrome





# Puk Wall

Wandleuchte, Hochvolt Halogen oder LED Power, dimmbar.  
Wall lamp, high voltage halogen or LED power, dimmable.



Puk Wall, chrome



Puk Wall, chrome



Puk Wall, gold



Puk Wall, black



Puk Wall, white

Puk Wall LED	Puk Wall Halogen	Wandabstand wall spacing	Gehäuse body
LED: <b>A+</b> 2 x 8W ~1.200lm ~2.800k	G9/QT14: <b>D</b> 1 x 60W ECO ~980lm ~2.800k		
2-0811-LED	2-0811	100 mm	chrome matt
2-0812-LED	2-0812	100 mm	chrome
2-0813-LED	2-0813	100 mm	nickel matt
2-0814-LED	2-0814	100 mm	white
2-0815-LED	2-0815	100 mm	black
2-0816-LED	2-0816	100 mm	24 carat gold plated
2-0817-LED	2-0817	100 mm	anthracite
2-08191-LED	2-08191	100 mm	yellow
2-08192-LED	2-08192	100 mm	red
2-08193-LED	2-08193	100 mm	orange
2-08194-LED	2-08194	100 mm	green

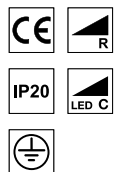
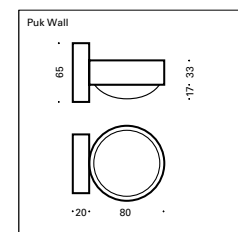

Bei den Puk Leuchten werden zu dem Leuchtenkopf die Gläser/Linsen und optional die Farbfilter separat dazubestellt! Artikelnummern entnehmen Sie bitte der Equipment-Tabelle auf Seite 59.

With the Puk lamps, the glasses, lenses and optional the color filters are ordered separately. Please check the equipment list on page 59 for item numbers.





# Puk Wall »+«

Wandleuchte, Hochvolt Halogen oder LED Power, dimmbar, Kopf **drehbar** mit Verstellstift.

Wall lamp, high voltage halogen or LED power, dimmable, head **rotatable** with adjusting pin.



Puk Wall »+«, chrome matt



Puk Wall »+«, chrome matt



Puk Wall »+«, chrome

Puk Wall »+« LED	Puk Wall »+« Halogen	Wandabstand wall spacing	Gehäuse body
LED: <b>A+</b> 2 x 8W ~1.200lm ~2.800k	G9/QT14: <b>D</b> 1 x 60W ECO ~980lm ~2.800k		
2-0801-LED	2-0801	110 mm	chrome matt
2-0802-LED	2-0802	110 mm	chrome
2-0803-LED	2-0803	110 mm	nickel matt
2-0804-LED	2-0804	110 mm	white/chrome
2-0805-LED	2-0805	110 mm	black/chrome
2-0806-LED	2-0806	110 mm	24 carat gold plated/chrome
2-0807-LED	2-0807	110 mm	anthracite/chrome

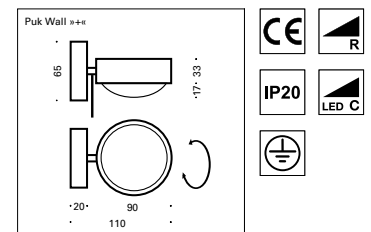

Bei den Puk Leuchten werden zu dem Leuchtenkopf die Gläser/Linsen und optional die Farbfilter separat dazubestellt! Artikelnummern entnehmen Sie bitte der Equipment-Tabelle auf Seite 59.

With the Puk lamps, the glasses, lenses and optional the color filters are ordered separately. Please check the equipment list on page 59 for item numbers.







# Puk Fix & Puk Fix »+«

Spiegelklemmleuchte, Hochvolt Halogen oder LED Power, dimmbar, Fix »+« Kopf drehbar mit Verstellstift.

Mirror clip lamp, high voltage halogen or LED power, dimmable, Fix »+« head rotatable with adjusting pin.



Puk Fix »+«, chrome



Puk Fix, chrome

Puk Fix LED	Puk Fix Halogen	Länge ab Spiegel length from mirror	Gehäuse body
LED: <b>A+</b> 2 x 8W ~1.200lm ~2.800k	G9/QT14: <b>D</b> 1 x 60W ECO ~980lm ~2.800k		
Puk Fix	Puk Fix		
2-08011-LED	2-08011	90 mm	chrome matt
2-08012-LED	2-08012	90 mm	chrome
2-08013-LED	2-08013	90 mm	nickel matt
2-08014-LED	2-08014	90 mm	white/chrome
2-08015-LED	2-08015	90 mm	black/chrome
2-08016-LED	2-08016	90 mm	24 carat gold plated/chrome
2-08017-LED	2-08017	90 mm	anthracite/chrome
Puk Fix »+«	Puk Fix »+«		
2-08031-LED	2-08031	100 mm	chrome matt
2-08032-LED	2-08032	100 mm	chrome
2-08033-LED	2-08033	100 mm	nickel matt
2-08034-LED	2-08034	100 mm	white/chrome
2-08035-LED	2-08035	100 mm	black/chrome
2-08036-LED	2-08036	100 mm	24 carat gold plated/chrome
2-08037-LED	2-08037	100 mm	anthracite/chrome

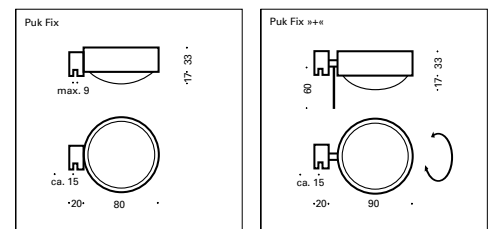

Bei den Puk Leuchten werden zu dem Leuchtenkopf die Gläser/Linsen und optional die Farbfilter separat dazubestellt! Artikelnummern entnehmen Sie bitte der Equipment-Tabelle auf Seite 59.

With the Puk lamps, the glasses, lenses and optional the color filters are ordered separately. Please check the equipment list on page 59 for item numbers.







# Puk Mirror & Puk Mirror »+«

Spiegelaufbauleuchte, Hochvolt Halogen oder LED Power, dimmbar, Mirror »+« Kopf drehbar mit Verstellstift.

Mirror mounting lamp, high voltage halogen or LED power, dimmable, Mirror »+« head rotatable with adjusting pin.



Puk Mirror, chrome



Puk Mirror »+«, chrome

Puk Mirror LED LED: <b>A*</b> 2 x 8W ~1.200lm ~2.800k	Puk Mirror Halogen G9/QT14: <b>D</b> 1 x 60W ECO ~980lm ~2.800k	Länge ab Spiegel length from mirror	Gehäuse body
Puk Mirror 2-08211-LED 2-08212-LED 2-08213-LED 2-08214-LED 2-08215-LED 2-08216-LED 2-08217-LED	Puk Mirror 2-08211 2-08212 2-08213 2-08214 2-08215 2-08216 2-08217	80 mm 80 mm 80 mm 80 mm 80 mm 80 mm 80 mm	chrome matt chrome nickel matt white black 24 carat gold plated anthracite
Puk Mirror »+« 2-08411-LED 2-08412-LED 2-08413-LED 2-08414-LED 2-08415-LED 2-08416-LED 2-08417-LED	Puk Mirror »+« 2-08411 2-08412 2-08413 2-08414 2-08415 2-08416 2-08417	90 mm 90 mm 90 mm 90 mm 90 mm 90 mm 90 mm	chrome matt chrome nickel matt white/chrome black/chrome 24 carat gold plated/chrome anthracite/chrome

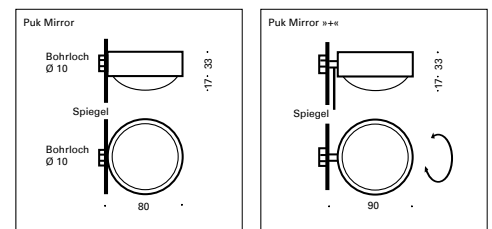

Bei den Puk Leuchten werden zu dem Leuchtenkopf die Gläser/Linsen und optional die Farbfilter separat dazubestellt! Artikelnummern entnehmen Sie bitte der Equipment-Tabelle auf Seite 59.

With the Puk lamps, the glasses, lenses and optional the color filters are ordered separately. Please check the equipment list on page 59 for item numbers.





# Puk One & Puk Plus

Wand- und Deckenleuchte, Hochvolt Halogen oder LED Power, dimmbar.  
Wall and Ceiling lamp, high voltage halogen or LED power, dimmable.



Puk One, chrome matt



Puk Plus, chrome



Puk Plus, chrome

Puk LED	Puk Halogen	ø x Höhe ø x height	Gehäuse body
LED: <b>A+</b> ~2.800k	G9/QT14: <b>D</b> ~2.800k		
One 8W ~600lm	One 33W ECO ~460lm		
2-08001-LED	2-08001	80 x 50 mm	chrome matt
2-08002-LED	2-08002	80 x 50 mm	chrome
2-08003-LED	2-08003	80 x 50 mm	nickel matt
2-08004-LED	2-08004	80 x 50 mm	white
2-08005-LED	2-08005	80 x 50 mm	black
2-08006-LED	2-08006	80 x 50 mm	24 carat gold plated
2-08007-LED	2-08007	80 x 50 mm	anthracite
Plus 8W ~600lm	Plus 48W ECO ~740lm		
2-18001-LED	2-18001	80 x 70 mm	chrome matt
2-18002-LED	2-18002	80 x 70 mm	chrome
2-18003-LED	2-18003	80 x 70 mm	nickel matt
2-18004-LED	2-18004	80 x 70 mm	white
2-18005-LED	2-18005	80 x 70 mm	black
2-18006-LED	2-18006	80 x 70 mm	24 carat gold plated
2-18007-LED	2-18007	80 x 70 mm	anthracite

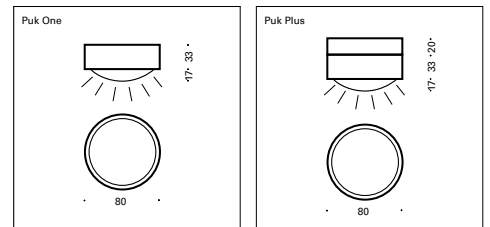

Bei den Puk Leuchten werden zu dem Leuchtenkopf die Gläser/Linsen und optional die Farbfilter separat dazubestellt! Artikelnummern entnehmen Sie bitte der Equipment-Tabelle auf Seite 59.

With the Puk lamps, the glasses, lenses and optional the color filters are ordered separately. Please check the equipment list on page 59 for item numbers.



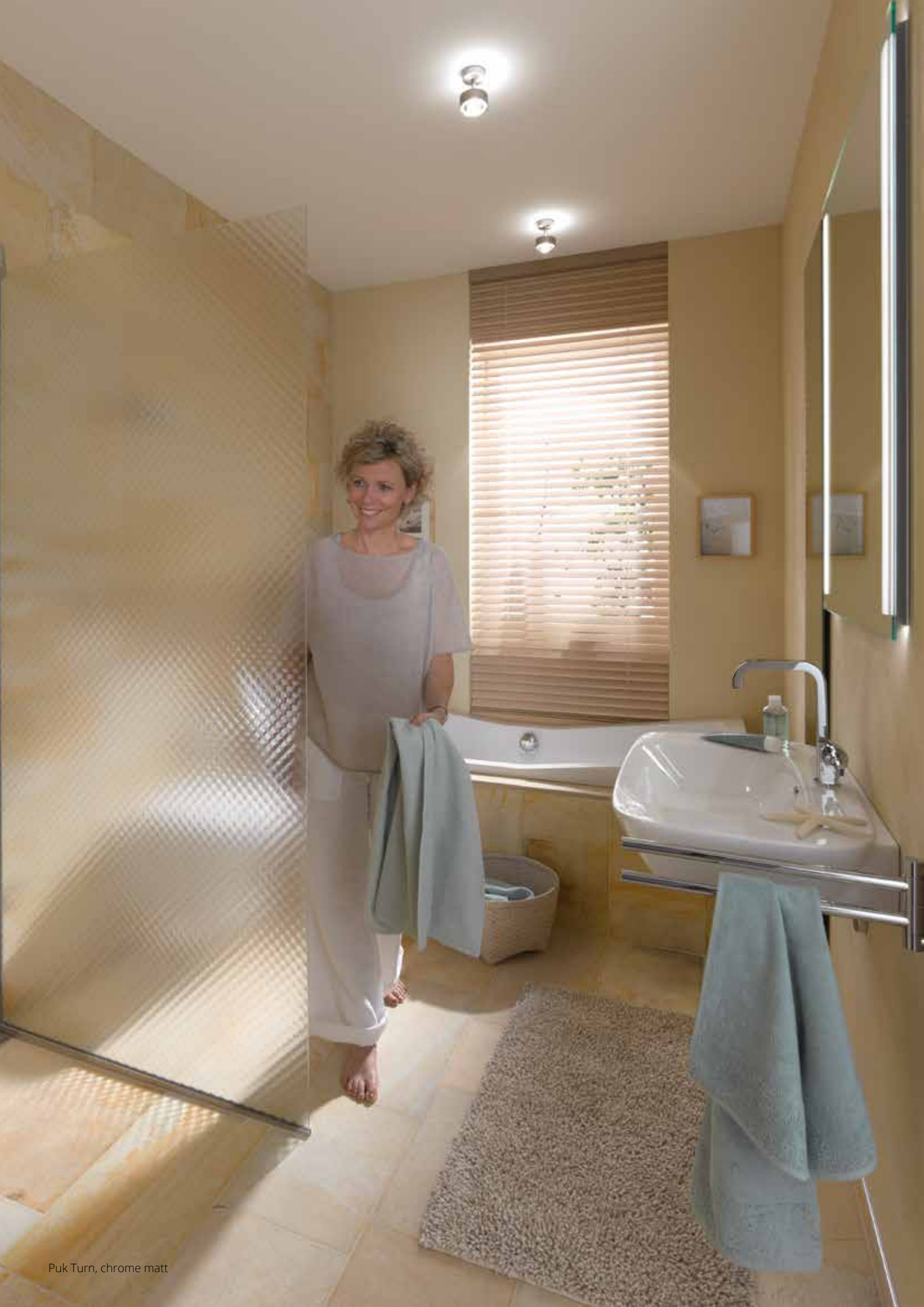



# Puk Turn

Deckenleuchte, Hochvolt Halogen oder LED Power, dimmbar.  
Ceiling lamp, high voltage halogen or LED power, dimmable.



Puk Turn, chrome



Puk Turn, chrome



Puk Turn, nickel matt

Puk Turn LED LED: <span style="background-color: green; color: white;">A+</span>	Puk Turn Halogen G9/QT14: <span style="background-color: orange; color: white;">D</span>	Ø x Höhe Ø x height	Gehäuse body
~1.200lm ~2.800k	1 x 48W ECO ~740lm ~2.800k		
up- & downlight 2 x 8W			
2-28001-LED	2-28001	80 x 120 mm	chrome matt
2-28002-LED	2-28002	80 x 120 mm	chrome
2-28003-LED	2-28003	80 x 120 mm	nickel matt
2-28004-LED	2-28004	80 x 120 mm	white/chrome
2-28005-LED	2-28005	80 x 120 mm	black/chrome
2-28006-LED	2-28006	80 x 120 mm	24 carat gold plated/chrome
2-28007-LED	2-28007	80 x 120 mm	anthracite/chrome
downlight 1 x 8W			
2-38001-LED	2-38001	80 x 120 mm	chrome matt
2-38002-LED	2-38002	80 x 120 mm	chrome
2-38003-LED	2-38003	80 x 120 mm	nickel matt
2-38004-LED	2-38004	80 x 120 mm	white/chrome
2-38005-LED	2-38005	80 x 120 mm	black/chrome
2-38006-LED	2-38006	80 x 120 mm	24 carat gold plated/chrome
2-38007-LED	2-38007	80 x 120 mm	anthracite/chrome

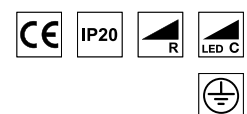
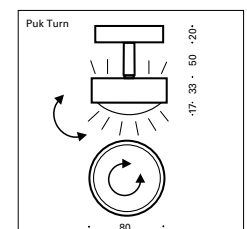

Bei den Puk Leuchten werden zu dem Leuchtenkopf die Gläser/Linsen und optional die Farbfilter separat dazubestellt! Artikelnummern entnehmen Sie bitte der Equipment-Tabelle auf Seite 59.

With the Puk lamps, the glasses, lenses and optional the color filters are ordered separately. Please check the equipment list on page 59 for item numbers.



Puk Side Single, chrome



Puk Side Single, nickel matt



Puk Side, Detail





# Puk Side Single

Wand-, Deckenleuchte, Hochvolt Halogen oder LED Power, dimmbar, Kopf drehbar mit Verstellstift.

Wall-/ceiling lamp, high voltage halogen or LED power, dimmable, head rotatable with adjusting pin.

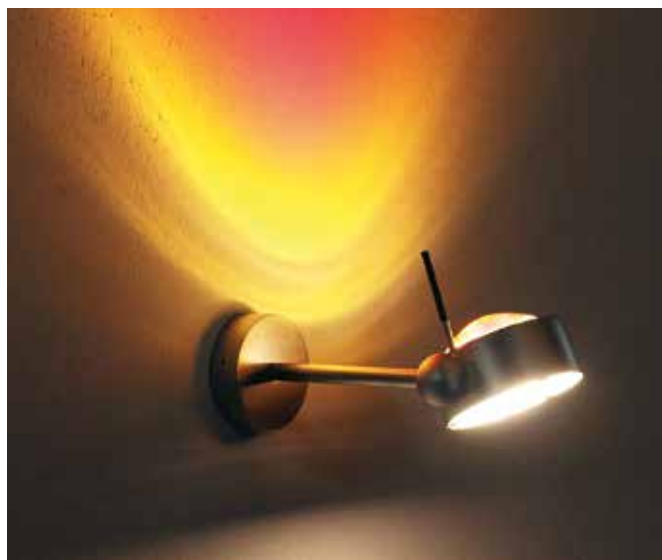

Puk Side Single, nickel matt



Puk Side Single, chrome matt

Puk Side Single LED	Puk Side Single Halogen	Armlänge arm length	Gehäuse body
LED: <b>A*</b> 2 x 8W ~1.200lm ~2.800k	G9/QT14: <b>D</b> 1 x 60W ECO ~980lm ~2.800k		
2-0821-LED	2-0821	100 mm	chrome matt
2-0822-LED	2-0822	100 mm	chrome
2-0823-LED	2-0823	100 mm	nickel matt
2-0824-LED	2-0824	100 mm	white/chrome
2-0825-LED	2-0825	100 mm	black/chrome
2-0827-LED	2-0827	100 mm	anthracite/chrome
2-0831-LED	2-0831	200 mm	chrome matt
2-0832-LED	2-0832	200 mm	chrome
2-0833-LED	2-0833	200 mm	nickel matt
2-0834-LED	2-0834	200 mm	white/chrome
2-0835-LED	2-0835	200 mm	black/chrome
2-0837-LED	2-0837	200 mm	anthracite/chrome
2-0861-LED	2-0861	300 mm	chrome matt
2-08062-LED	2-08062	300 mm	chrome
2-0863-LED	2-0863	300 mm	nickel matt
2-0864-LED	2-0864	300 mm	white/chrome
2-0865-LED	2-0865	300 mm	black/chrome
2-0867-LED	2-0867	300 mm	anthracite/chrome
2-0871-LED	2-0871	400 mm	chrome matt
2-0872-LED	2-0872	400 mm	chrome
2-0873-LED	2-0873	400 mm	nickel matt
2-0874-LED	2-0874	400 mm	white/chrome
2-0875-LED	2-0875	400 mm	black/chrome
2-0877-LED	2-0877	400 mm	anthracite/chrome

Puk Side Single LED	Puk Side Single Halogen	Armlänge arm length	Gehäuse body
LED: <b>A*</b> 2 x 8W ~1.200lm ~2.800k	G9/QT14: <b>D</b> 1 x 60W ECO ~980lm ~2.800k		
2-0881-LED	2-0881	600 mm	chrome matt
2-0882-LED	2-0882	600 mm	chrome
2-0883-LED	2-0883	600 mm	nickel matt
2-0884-LED	2-0884	600 mm	white/chrome
2-0885-LED	2-0885	600 mm	black/chrome
2-0887-LED	2-0887	600 mm	anthracite/chrome

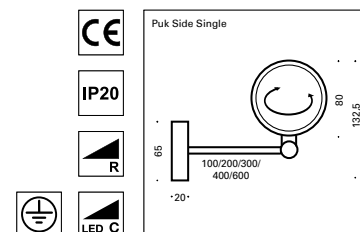

Bei den Puk Leuchten werden zu dem Leuchtenkopf die Gläser/Linsen und optional die Farbfilter separat dazubestellt! Artikelnummern entnehmen Sie bitte der Equipment-Tabelle auf Seite 59.

With the Puk lamps, the glasses, lenses and optional the color filters are ordered separately. Please check the equipment list on page 59 for item numbers.



Puk Side Twin, chrome



# Puk Side Twin

Wand-, Deckenleuchte, Hochvolt Halogen oder LED Power, dimmbar, Köpfe drehbar mit Verstellstift.

Wall-/ceiling lamp, high voltage halogen or LED power, dimmable, heads rotatable with adjusting pin.



Puk Side Twin, nickel matt



Puk Side Twin, nickel matt

Puk Side Twin LED	Puk Side Twin Halogen	Armlänge arm length	Gehäuse body
LED: <b>A*</b> 4 x 8W ~2.400lm ~2.800k	G9/QT14: <b>D</b> 2 x 60W ECO ~1.960lm ~2.800k		
2-0841-LED	2-0841	100 mm	chrome matt
2-0842-LED	2-0842	100 mm	chrome
2-0843-LED	2-0843	100 mm	nickel matt
2-0844-LED	2-0844	100 mm	white/chrome
2-0845-LED	2-0845	100 mm	black/chrome
2-0847-LED	2-0847	100 mm	anthracite/chrome
2-0851-LED	2-0851	200 mm	chrome matt
2-0852-LED	2-0852	200 mm	chrome
2-0853-LED	2-0853	200 mm	nickel matt
2-0854-LED	2-0854	200 mm	white/chrome
2-0855-LED	2-0855	200 mm	black/chrome
2-0857-LED	2-0857	200 mm	anthracite/chrome
2-0891-LED	2-0891	300 mm	chrome matt
2-0892-LED	2-0892	300 mm	chrome
2-0893-LED	2-0893	300 mm	nickel matt
2-0894-LED	2-0894	300 mm	white/chrome
2-0895-LED	2-0895	300 mm	black/chrome
2-0897-LED	2-0897	300 mm	anthracite/chrome
2-08101-LED	2-08101	400 mm	chrome matt
2-08102-LED	2-08102	400 mm	chrome
2-08103-LED	2-08103	400 mm	nickel matt
2-08104-LED	2-08104	400 mm	white/chrome
2-08105-LED	2-08105	400 mm	black/chrome
2-08107-LED	2-08107	400 mm	anthracite/chrome

Puk Side Twin LED	Puk Side Twin Halogen	Armlänge arm length	Gehäuse body
LED: <b>A*</b> 4 x 8W ~2.400lm ~2.800k	G9/QT14: <b>D</b> 2 x 60W ECO ~1.960lm ~2.800k		
2-08111-LED	2-08111	600 mm	chrome matt
2-08112-LED	2-08112	600 mm	chrome
2-08113-LED	2-08113	600 mm	nickel matt
2-08114-LED	2-08114	600 mm	white/chrome
2-08115-LED	2-08115	600 mm	black/chrome
2-08117-LED	2-08117	600 mm	anthracite/chrome

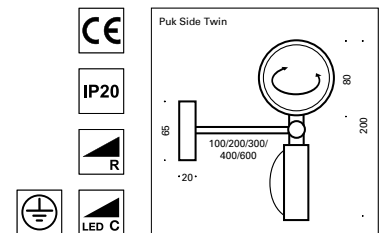

Bei den Puk Leuchten werden zu dem Leuchtenkopf die Gläser/Linsen und optional die Farbfilter separat dazubestellt! Artikelnummern entnehmen Sie bitte der Equipment-Tabelle auf Seite 59.

With the Puk lamps, the glasses, lenses and optional the color filters are ordered separately. Please check the equipment list on page 59 for item numbers.



Puk Wing Single, nickel matt





# Puk Wing Single

Wand-, Deckenleuchte, Hochvolt Halogen oder LED Power, dimmbar, Kopf drehbar mit Verstellstift, Arm schwenkbar.

Wall/Ceiling lamp, high voltage halogen or LED power, dimmable, head rotatable with adjusting pin, arm pivoting.



Puk Wing Single, nickel matt



Puk Wing Detail

	Puk Wing Single LED	Puk Wing Single Halogen	Armlänge arm length	Gehäuse body
	LED: <b>A*</b> 2 x 8W ~1.200lm ~2.800k	G9/QT14: <b>D</b> 1 x 60W ECO ~980lm ~2.800k		
Wand Wall	2-08201-LED	2-08201	200 mm	chrome matt
	2-08202-LED	2-08202	200 mm	chrome
	2-08203-LED	2-08203	200 mm	nickel matt
	2-08204-LED	2-08204	200 mm	white/chrome
	2-08205-LED	2-08205	200 mm	black/chrome
	2-08207-LED	2-08207	200 mm	anthracite/chrome
	2-08301-LED	2-08301	300 mm	chrome matt
	2-08302-LED	2-08302	300 mm	chrome
	2-08303-LED	2-08303	300 mm	nickel matt
	2-08304-LED	2-08304	300 mm	white/chrome
	2-08305-LED	2-08305	300 mm	black/chrome
	2-08307-LED	2-08307	300 mm	anthracite/chrome
	2-08401-LED	2-08401	400 mm	chrome matt
	2-08402-LED	2-08402	400 mm	chrome
2-08403-LED	2-08403	400 mm	nickel matt	
2-08404-LED	2-08404	400 mm	white/chrome	
2-08405-LED	2-08405	400 mm	black/chrome	
2-08407-LED	2-08407	400 mm	anthracite/chrome	

	Puk Wing Single LED	Puk Wing Single Halogen	Armlänge arm length	Gehäuse body
	LED: <b>A*</b> 2 x 8W ~1.200lm ~2.800k	G9/QT14: <b>D</b> 1 x 60W ECO ~980lm ~2.800k		
Decke Ceiling	2-08601-LED	2-08601	600 mm	chrome matt
	2-08602-LED	2-08602	600 mm	chrome
	2-08603-LED	2-08603	600 mm	nickel matt
	2-08604-LED	2-08604	600 mm	white/chrome
	2-08605-LED	2-08605	600 mm	black/chrome
	2-08607-LED	2-08607	600 mm	anthracite/chrome
	2-08801-LED	2-08801	800 mm	chrome matt
	2-08802-LED	2-08802	800 mm	chrome
	2-08803-LED	2-08803	800 mm	nickel matt
	2-08804-LED	2-08804	800 mm	white/chrome
	2-08805-LED	2-08805	800 mm	black/chrome
	2-08807-LED	2-08807	800 mm	anthracite/chrome
	2-081001-LED	2-081001	1.000 mm	chrome matt
	2-081002-LED	2-081002	1.000 mm	chrome
	2-081003-LED	2-081003	1.000 mm	nickel matt
	2-081004-LED	2-081004	1.000 mm	white/chrome
	2-081005-LED	2-081005	1.000 mm	black/chrome
	2-081007-LED	2-081007	1.000 mm	anthracite/chrome
	2-081201-LED	2-081201	1.250 mm	chrome matt
	2-081202-LED	2-081202	1.250 mm	chrome
	2-081203-LED	2-081203	1.250 mm	nickel matt
	2-081204-LED	2-081204	1.250 mm	white/chrome
	2-081205-LED	2-081205	1.250 mm	black/chrome
	2-081207-LED	2-081207	1.250 mm	anthracite/chrome

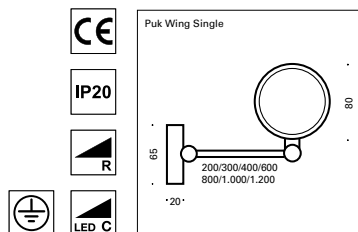

Bei den Puk Leuchten werden zu dem Leuchtenkopf die Gläser/Linsen und optional die Farbfilter separat dazubestellt! Artikelnummern entnehmen Sie bitte der Equipment-Tabelle auf Seite 59.

With the Puk lamps, the glasses, lenses and optional the color filters are ordered separately. Please check the equipment list on page 59 for item numbers.



Puk Wing Twin, chrome





# Puk Wing Twin

Wand-, Deckenleuchte, Hochvolt Halogen oder LED Power, dimmbar, Köpfe drehbar mit Verstellstift, Arm schwenkbar.

Wall/Ceiling lamp, high voltage halogen or LED power, dimmable, heads rotatable with adjusting pin, arm pivoting.



Puk Wing Twin, chrome matt



Puk Wing Twin, nickel matt

Wand Wall	Puk Wing Twin LED	Puk Wing Twin Halogen	Armlänge arm length	Gehäuse body
	LED: <b>A+</b> 4 x 8W ~2.400lm ~2.800k	G9/QT14: <b>D</b> 2 x 60W ECO ~1.960lm ~2.800k		
	2-09201-LED	2-09201	200 mm	chrome matt
	2-09202-LED	2-09202	200 mm	chrome
	2-09203-LED	2-09203	200 mm	nickel matt
	2-09204-LED	2-09204	200 mm	white/chrome
	2-09205-LED	2-09205	200 mm	black/chrome
	2-09207-LED	2-09207	200 mm	anthracite/chrome
	2-09301-LED	2-09301	300 mm	chrome matt
	2-09302-LED	2-09302	300 mm	chrome
	2-09303-LED	2-09303	300 mm	nickel matt
	2-09304-LED	2-09304	300 mm	white/chrome
	2-09305-LED	2-09305	300 mm	black/chrome
	2-09307-LED	2-09307	300 mm	anthracite/chrome
	2-09401-LED	2-09401	400 mm	chrome matt
	2-09402-LED	2-09402	400 mm	chrome
	2-09403-LED	2-09403	400 mm	nickel matt
	2-09404-LED	2-09404	400 mm	white/chrome
	2-09405-LED	2-09405	400 mm	black/chrome
	2-09407-LED	2-09407	400 mm	anthracite/chrome

Decke Ceiling	Puk Wing Twin LED	Puk Wing Twin Halogen	Armlänge arm length	Gehäuse body
	LED: <b>A+</b> 4 x 8W ~2.400lm ~2.800k	G9/QT14: <b>D</b> 2 x 60W ECO ~1.960lm ~2.800k		
	2-09601-LED	2-09601	600 mm	chrome matt
	2-09602-LED	2-09602	600 mm	chrome
	2-09603-LED	2-09603	600 mm	nickel matt
	2-09604-LED	2-09604	600 mm	white/chrome
	2-09605-LED	2-09605	600 mm	black/chrome
	2-09607-LED	2-09607	600 mm	anthracite/chrome
	2-09801-LED	2-09801	800 mm	chrome matt
	2-09802-LED	2-09802	800 mm	chrome
	2-09803-LED	2-09803	800 mm	nickel matt
	2-09804-LED	2-09804	800 mm	white/chrome
	2-09805-LED	2-09805	800 mm	black/chrome
	2-09807-LED	2-09807	800 mm	anthracite/chrome
	2-091001-LED	2-091001	1.000 mm	chrome matt
	2-091002-LED	2-091002	1.000 mm	chrome
	2-091003-LED	2-091003	1.000 mm	nickel matt
	2-091004-LED	2-091004	1.000 mm	white/chrome
	2-091005-LED	2-091005	1.000 mm	black/chrome
	2-091007-LED	2-091007	1.000 mm	anthracite/chrome
	2-091201-LED	2-091201	1.250 mm	chrome matt
	2-091202-LED	2-091202	1.250 mm	chrome
	2-091203-LED	2-091203	1.250 mm	nickel matt
	2-091204-LED	2-091204	1.250 mm	white/chrome
	2-091205-LED	2-091205	1.250 mm	black/chrome
	2-091207-LED	2-091207	1.250 mm	anthracite/chrome

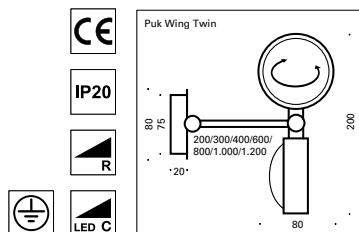

Bei den Puk Leuchten werden zu dem Leuchtenkopf die Gläser/Linsen und optional die Farbfilter separat dazubestellt! Artikelnummern entnehmen Sie bitte der Equipment-Tabelle auf Seite 59.

With the Puk lamps, the glasses, lenses and optional the color filters are ordered separately. Please check the equipment list on page 59 for item numbers.



Puk Long Double, chrome



# Puk Long One & Puk Long Double

Pendelleuchte, Hochvolt Halogen oder LED Power, dimmbar.  
Pendant lamp, high voltage halogen or LED power, dimmable.



Puk Long One, chrome



Puk Long Double, chrome



Puk Long One, chrome

Puk Long LED	Puk Long Halogen	B x Pendellänge w x pendular length	Gehäuse body
LED: <b>A+</b> ~2.800k, 1/4 x 8W	G9/QT14: <b>D</b> ~2.800k ~740lm & ~1.960lm		
One ~600lm downlight	One 1 x 48W ECO downlight		
5-08001-1-LED	5-08001-1	80 x 1.400 mm	chrome matt
5-08002-1-LED	5-08002-1	80 x 1.400 mm	chrome
5-08003-1-LED	5-08003-1	80 x 1.400 mm	nickel matt
5-08004-1-LED	5-08004-1	80 x 1.400 mm	white/chrome
5-08005-1-LED	5-08005-1	80 x 1.400 mm	black/chrome
5-08006-1-LED	5-08006-1	80 x 1.400 mm	24 carat gold plated/chrome
5-08007-1-LED	5-08007-1	80 x 1.400 mm	anthracite/chrome
Double ~2.400lm up- & downlight	Double 2 x 60W ECO up- & downlight		
5-08001-2-LED	5-08001-2	200 x 1.400 mm	chrome matt
5-08002-2-LED	5-08002-2	200 x 1.400 mm	chrome
5-08003-2-LED	5-08003-2	200 x 1.400 mm	nickel matt
5-08004-2-LED	5-08004-2	200 x 1.400 mm	white/chrome
5-08005-2-LED	5-08005-2	200 x 1.400 mm	black/chrome
5-08006-2-LED	5-08006-2	200 x 1.400 mm	24 carat gold plated/chrome
5-08007-2-LED	5-08007-2	200 x 1.400 mm	anthracite/chrome

5-07951 Kabelverlängerung lfd. Meter cable extension per meter

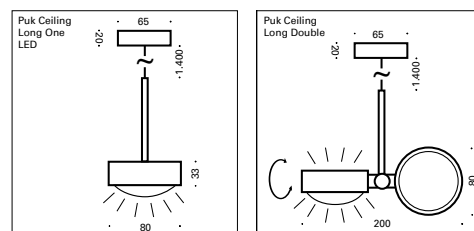

Puk Long Double Halogen:



Bei den Puk Leuchten werden zu dem Leuchtenkopf die Gläser/Linsen und optional die Farbfilter separat dazubestellt! Artikelnummern entnehmen Sie bitte der Equipment-Tabelle auf Seite 59.

With the Puk lamps, the glasses, lenses and optional the color filters are ordered separately. Please check the equipment list on page 59 for item numbers.





Puk Ceiling Sister Twin, chrome



# Puk Ceiling Sister Twin

Deckenleuchte, Hochvolt Halogen oder LED Power, dimmbar, Köpfe drehbar mit Verstellstift, Arme schwenkbar.

Ceiling lamp, high voltage halogen or LED power, dimmable, heads rotatable with adjusting pin, arms pivoting.



Puk Ceiling Sister Twin, chrome

Puk Ceiling Sister LED	Puk Ceiling Sister Halogen	Arm Länge arm length	Gehäuse body	Puk Ceiling Sister LED	Puk Ceiling Sister Halogen	Arm Länge arm length	Gehäuse body
LED: <b>A+</b> 8 x 8W ~4.800lm ~2.800k	G9/QT14: <b>D</b> 4 x 60W ECO ~3.920lm ~2.800k			LED: <b>A+</b> 8 x 8W ~4.800lm ~2.800k	G9/QT14: <b>D</b> 4 x 60W ECO ~3.920lm ~2.800k		
5-081201-2-LED	5-081201-2	200 mm	chrome matt	5-0811001-2-LED	5-0811001-2	1.000 mm	chrome matt
5-081202-2-LED	5-081202-2	200 mm	chrome	5-0811002-2-LED	5-0811002-2	1.000 mm	chrome
5-081203-2-LED	5-081203-2	200 mm	nickel matt	5-0811003-2-LED	5-0811003-2	1.000 mm	nickel matt
5-081204-2-LED	5-081204-2	200 mm	white/chrome	5-0811004-2-LED	5-0811004-2	1.000 mm	white/chrome
5-081205-2-LED	5-081205-2	200 mm	black/chrome	5-0811005-2-LED	5-0811005-2	1.000 mm	black/chrome
5-081207-2-LED	5-081207-2	200 mm	anthracite/chrome	5-0811007-2-LED	5-0811007-2	1.000 mm	anthracite/chrome
5-081401-2-LED	5-081401-2	400 mm	chrome matt	5-0811201-2-LED	5-0811201-2	1.250 mm	chrome matt
5-081402-2-LED	5-081402-2	400 mm	chrome	5-0811202-2-LED	5-0811202-2	1.250 mm	chrome
5-081403-2-LED	5-081403-2	400 mm	nickel matt	5-0811203-2-LED	5-0811203-2	1.250 mm	nickel matt
5-081404-2-LED	5-081404-2	400 mm	white/chrome	5-0811204-2-LED	5-0811204-2	1.250 mm	white/chrome
5-081405-2-LED	5-081405-2	400 mm	black/chrome	5-0811205-2-LED	5-0811205-2	1.250 mm	black/chrome
5-081407-2-LED	5-081407-2	400 mm	anthracite/chrome	5-0811207-2-LED	5-0811207-2	1.250 mm	anthracite/chrome
5-081601-2-LED	5-081601-2	600 mm	chrome matt				
5-081602-2-LED	5-081602-2	600 mm	chrome				
5-081603-2-LED	5-081603-2	600 mm	nickel matt				
5-081604-2-LED	5-081604-2	600 mm	white/chrome				
5-081605-2-LED	5-081605-2	600 mm	black/chrome				
5-081607-2-LED	5-081607-2	600 mm	anthracite/chrome				
5-081801-2-LED	5-081801-2	800 mm	chrome matt				
5-081802-2-LED	5-081802-2	800 mm	chrome				
5-081803-2-LED	5-081803-2	800 mm	nickel matt				
5-081804-2-LED	5-081804-2	800 mm	white/chrome				
5-081805-2-LED	5-081805-2	800 mm	black/chrome				
5-081807-2-LED	5-081807-2	800 mm	anthracite/chrome				

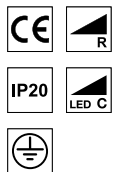
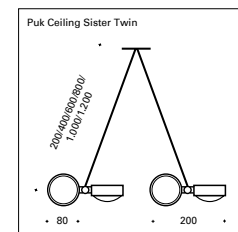

Bei den Puk Leuchten werden zu dem Leuchtenkopf die Gläser/Linsen und optional die Farbfilter separat dazubestellt! Artikelnummern entnehmen Sie bitte der Equipment-Tabelle auf Seite 59.

With the Puk lamps, the glasses, lenses and optional the color filters are ordered separately. Please check the equipment list on page 59 for item numbers.







# Puk Quartett & Puk Sixtett

Pendelleuchte, Hochvolt Halogen oder LED Power, dimmbar.  
Pendant lamp, high voltage halogen or LED power, dimmable.



Puk Sixtett, chrome



Puk Quartett, chrome matt



Beide Aufhängungen möglich, da das Zubehör im Lieferumfang enthalten ist. Pendellänge stufenlos einstellbar.

Both suspensions possible. The equipment for mounting is included in the delivery. Pendular length adjustable.

Puk LED	Puk Halogen	L x Pendellänge l x pendular length	Gehäuse body
LED: <b>A+</b> ~2.800k, 8/12 x 8W	G9/QT14: <b>D</b> ~2.800k ~3.920lm & ~5.880lm		
Quartett ~4.800lm	Quartett 4 x 60W ECO		
5-08801-4-LED	5-08801-4	805 x 2.000 mm	chrome matt
5-08802-4-LED	5-08802-4	805 x 2.000 mm	chrome
5-08803-4-LED	5-08803-4	805 x 2.000 mm	nickel matt
5-08804-4-LED	5-08804-4	805 x 2.000 mm	white/chrome
5-08805-4-LED	5-08805-4	805 x 2.000 mm	black/chrome
5-08807-4-LED	5-08807-4	805 x 2.000 mm	anthracite/chrome
Sixtett ~7.200lm	Sixtett 6 x 60W ECO		
5-081201-6-LED	5-081201-6	1.260 x 2.000 mm	chrome matt
5-081202-6-LED	5-081202-6	1.260 x 2.000 mm	chrome
5-081203-6-LED	5-081203-6	1.260 x 2.000 mm	nickel matt
5-081204-6-LED	5-081204-6	1.260 x 2.000 mm	white/chrome
5-081205-6-LED	5-081205-6	1.260 x 2.000 mm	black/chrome
5-081207-6-LED	5-081207-6	1.260 x 2.000 mm	anthracite/chrome

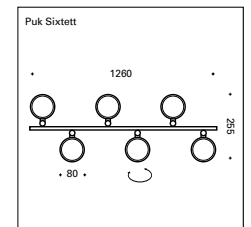
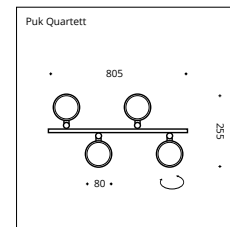

LED:

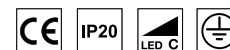

Halogen:

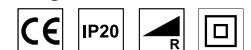

Bei den Puk Leuchten werden zu dem Leuchtenkopf die Gläser/Linsen und optional die Farbfilter separat dazubestellt! Artikelnummern entnehmen Sie bitte der Equipment-Tabelle auf Seite 59.

With the Puk lamps, the glasses, lenses and optional the color filters are ordered separately. Please check the equipment list on page 59 for item numbers.





# Puk Mike

Stehleuchte mit senkrechtem Leuchtenkopf, Filterfarbe ändert sich mit dem Sichtwinkel. Niedervolt Halogen (mit Dimmer) oder LED Power (nur mit Schalter).

Floor lamp with a vertical head, the color of the filter changes with a different viewing angle. Low voltage halogen (with dimmer) or LED power (only with switch).



Puk Mike chrome



Puk Mike chrome



Puk Mike chrome



Puk Mike chrome



Puk Mike Farbfilter colorfilter

Puk Mike Table  
LED  
LED: **A\***  
2 x 8W  
~1.200lm ~2.800k

Puk Mike Table  
Halogen  
GY6.35/QT-LP12: **B**  
1 x 50W IRC  
~1.250lm ~2.800k

Höhe  
height

Puk Mike Floor  
LED  
LED: **A\***  
2 x 8W  
~1.200lm ~2.800k

Puk Mike Floor  
Halogen  
GY6.35/QT-LP12: **B**  
1 x 50W IRC  
~1.250lm ~2.800k

Höhe  
height

Gehäuse  
body

6-084801-LED  
6-084802-LED  
6-084803-LED  
6-084804-LED  
6-084805-LED  
6-084807-LED

6-084801  
6-084802  
6-084803  
6-084804  
6-084805  
6-084807

480 mm  
480 mm  
480 mm  
480 mm  
480 mm  
480 mm

6-0813301-LED  
6-0813302-LED  
6-0813303-LED  
6-0813304-LED  
6-0813305-LED  
6-0813307-LED

6-0813301  
6-0813302  
6-0813303  
6-0813304  
6-0813305  
6-0813307

1.330 mm  
1.330 mm  
1.330 mm  
1.330 mm  
1.330 mm  
1.330 mm

chrome matt  
chrome  
nickel matt  
white/chrome  
black/chrome  
anthracite/chrome

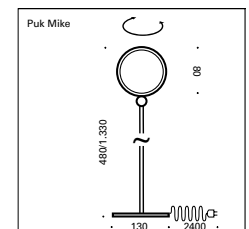

Bei den Puk Leuchten werden zu dem Leuchtenkopf die Gläser/Linsen und optional die Farbfilter separat dazubestellt! Artikelnummern entnehmen Sie bitte der Equipment-Tabelle auf Seite 59.

With the Puk lamps, the glasses, lenses and optional the color filters are ordered separately. Please check the equipment list on page 59 for item numbers.



Puk Eye Table, chrome





# Puk Eye Table & Floor

Tisch- oder Standleuchte, Niedervolt Halogen (IRC 50 Watt, 12 Volt) mit Dimmer oder LED Power (nur mit Schalter).

Table or floor lamp, low voltage halogen (IRC 50 watts, 12 volt) dimmable or LED power (only with switch).



Puk Eye black/chrome & white/chrome



Puk Eye Table, chrome



Puk Eye Floor, chrome

Puk Eye LED	Puk Eye Halogen	Höhe height	Puk Eye LED	Puk Eye Halogen	Höhe height	Gehäuse body
LED: <b>A+</b> 2 x 8W ~1.200lm ~2.800k	GY6.35/QT-LP12: <b>B</b> 1 x 50W IRC ~1.250lm ~2.800k		LED: <b>A+</b> 2 x 8W ~1.200lm ~2.800k	GY6.35/QT-LP12: <b>B</b> 1 x 50W IRC ~1.250lm ~2.800k		
<b>Table</b>	<b>Table</b>		<b>Table</b>	<b>Table</b>		
6-083701-LED	6-083701	370 mm	6-084701-LED	6-084701	470 mm	chrome matt
6-083702-LED	6-083702	370 mm	6-084702-LED	6-084702	470 mm	chrome
6-083703-LED	6-083703	370 mm	6-084703-LED	6-084703	470 mm	nickel matt
6-083704-LED	6-083704	370 mm	6-084704-LED	6-084704	470 mm	white/chrome
6-083705-LED	6-083705	370 mm	6-084705-LED	6-084705	470 mm	black/chrome
6-083707-LED	6-083707	370 mm	6-084707-LED	6-084707	470 mm	anthracite/chrome
<b>Floor</b>	<b>Floor</b>		<b>Floor</b>	<b>Floor</b>		
6-0810701-LED	6-0810701	1070 mm	6-0813201-LED	6-0813201	1320 mm	chrome matt
6-0810702-LED	6-0810702	1070 mm	6-0813202-LED	6-0813202	1320 mm	chrome
6-0810703-LED	6-0810703	1070 mm	6-0813203-LED	6-0813203	1320 mm	nickel matt
6-0810704-LED	6-0810704	1070 mm	6-0813204-LED	6-0813204	1320 mm	white/chrome
6-0810705-LED	6-0810705	1070 mm	6-0813205-LED	6-0813205	1320 mm	black/chrome
6-0810707-LED	6-0810707	1070 mm	6-0813207-LED	6-0813207	1320 mm	anthracite/chrome

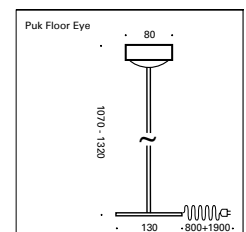
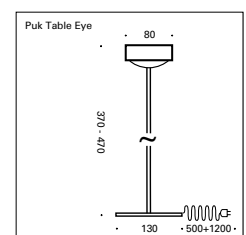

Bei den Puk Leuchten werden zu dem Leuchtenkopf die Gläser/Linsen und optional die Farbfilter separat dazubestellt! Artikelnummern entnehmen Sie bitte der Equipment-Tabelle auf Seite 59.

With the Puk lamps, the glasses, lenses and optional the color filters are ordered separately. Please check the equipment list on page 59 for item numbers.





Puk Table Twin, nickel matt



# Puk Table

Tischleuchte, Niedervolt Halogen (mit Tischdimmer) oder LED Power (nicht erhältlich mit Dimmer), Köpfe drehbar mit Verstellstift, Arm schwenkbar.

Table lamp, low voltage halogen (tabletop dimmer) or LED power (not available with dimmer), heads rotatable with adjusting pin, arm pivoting.



Puk Table Single, chrome



Puk Table Single, nickel matt

Puk Table Single LED	Puk Table Single Halogen	Puk Table Twin LED	Puk Table Twin Halogen	Armlänge arm length	Gehäuse body
LED: <b>A*</b> 2 x 8W ~1.200lm ~2.800k	GY6.35/QT-LP12: <b>B</b> 1 x 50W IRC ~1.250lm ~2.800k	LED: <b>A*</b> 4 x 8W ~2.400lm ~2.800k	GY6.35/QT-LP12: <b>B</b> 2 x 50W IRC ~2.500lm ~2.800k		
6-08601-1-LED	6-08601-1	6-08601-2-LED	6-08601-2	600 mm	chrome matt
6-08602-1-LED	6-08602-1	6-08602-2-LED	6-08602-2	600 mm	chrome
6-08603-1-LED	6-08603-1	6-08603-2-LED	6-08603-2	600 mm	nickel matt
6-08602-1-W-LED	6-08602-1-W	6-08602-2-W-LED	6-08602-2-W	600 mm	white/chrome
6-08602-1-S-LED	6-08602-1-S	6-08602-2-S-LED	6-08602-2-S	600 mm	black/chrome
6-08607-1-LED	6-08607-1	6-08607-2-LED	6-08607-2	600 mm	anthracite/chrome
6-08801-1-LED	6-08801-1	6-08801-2-LED	6-08801-2	800 mm	chrome matt
6-08802-1-LED	6-08802-1	6-08802-2-LED	6-08802-2	800 mm	chrome
6-08803-1-LED	6-08803-1	6-08803-2-LED	6-08803-2	800 mm	nickel matt
6-08802-1-W-LED	6-08802-1-W	6-08802-2-W-LED	6-08802-2-W	800 mm	white/chrome
6-08802-1-S-LED	6-08802-1-S	6-08802-2-S-LED	6-08802-2-S	800 mm	black/chrome
6-08807-1-LED	6-08807-1	6-08807-2-LED	6-08807-2	800 mm	anthracite/chrome

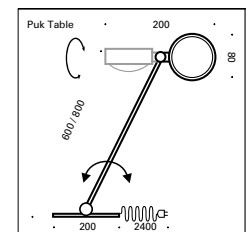

Bei den Puk Leuchten werden zu dem Leuchtenkopf die Gläser/Linsen und optional die Farbfilter separat dazubestellt! Artikelnummern entnehmen Sie bitte der Equipment-Tabelle auf Seite 59.

With the Puk lamps, the glasses, lenses and optional the color filters are ordered separately. Please check the equipment list on page 59 for item numbers.



Puk Floor Mini Single, chrome





# Puk Floor Mini

Stand- und Leseleuchte, Niedervolt Halogen (mit Fußdimmer) oder LED Power (nicht mit Dimmer erhältlich), Kopf drehbar mit Verstellstift. Arm schwenkbar.

Floor and reading lamp, low voltage halogen (floor dimmer) or LED power (not available with dimmer), head rotatable with adjusting pin, arm pivoting.



Puk Floor Mini Single, chrome



Schwarzer Kopf und Fuß, black head and base

Puk Floor Mini LED	Puk Floor Mini Halogen	Armlänge arm length	Gehäuse body
LED: <b>A*</b> ~2.800k	GY6.35/QT-LP12: <b>B</b> ~2.800k		
<b>Single</b> 2 x 8W ~1.200lm	<b>Single</b> 1 x 50W IRC ~1.250lm		
6-081201-1-LED	6-081201-1	1.250 mm	chrome matt
6-081202-1-LED	6-081202-1	1.250 mm	chrome
6-081203-1-LED	6-081203-1	1.250 mm	nickel matt
6-081202-1-W-LED	6-081202-1-W	1.250 mm	white/chrome
6-081202-1-S-LED	6-081202-1-S	1.250 mm	black/chrome
6-081207-1-LED	6-081207-1	1.250 mm	anthracite/chrome
<b>Twin</b> 4 x 8W ~2.400lm	<b>Twin</b> 2 x 50W IRC ~2.500lm		
6-081201-2-LED	6-081201-2	1.250 mm	chrome matt
6-081202-2-LED	6-081202-2	1.250 mm	chrome
6-081203-2-LED	6-081203-2	1.250 mm	nickel matt
6-081202-2-W-LED	6-081202-2-W	1.250 mm	white/chrome
6-081202-2-S-LED	6-081202-2-S	1.250 mm	black/chrome
6-081207-2-LED	6-081207-2	1.250 mm	anthracite/chrome

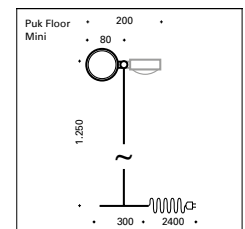

LED:



Halogen:



Bei den Puk Leuchten werden zu dem Leuchtenkopf die Gläser/Linsen und optional die Farbfilter separat dazubestellt! Artikelnummern entnehmen Sie bitte der Equipment-Tabelle auf Seite 59.

With the Puk lamps, the glasses, lenses and optional the color filters are ordered separately. Please check the equipment list on page 59 for item numbers.





Puk Floor Sister, chrome



# Puk Floor Sister

Stand- und Leseleuchte, Niedervolt Halogen (mit Fußdimmer) oder LED Power (nicht mit Dimmer erhältlich), Köpfe drehbar mit Verstellstift, Arme schwenkbar.

Floor and reading lamp, low voltage halogen (floor dimmer) or LED power (not available with dimmer), heads rotatable with adjusting pin, arms pivoting.



Puk Floor Sister, chrome



Weißer Kopf, white head



Weißer Fuß, white base

Puk Floor Sister LED	Puk Floor Sister Halogen	Armlänge arm length	Gehäuse body
LED: <b>A*</b> 4 x 8W ~2.400lm ~2.800k	GY6.35/QT-LP12: <b>B</b> 2 x 50W IRC ~2.500lm ~2.800k		
6-0821201-LED	6-0821201	2 x 1.250 mm	chrome matt
6-0821202-LED	6-0821202	2 x 1.250 mm	chrome
6-0821203-LED	6-0821203	2 x 1.250 mm	nickel matt
6-0821202-W-LED	6-0821202-W	2 x 1.250 mm	white/chrome
6-0821202-S-LED	6-0821202-S	2 x 1.250 mm	black/chrome
6-0821207-LED	6-0821207	2 x 1.250 mm	anthracite/chrome

LED:  



Halogen:  

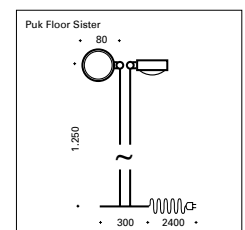

Bei den Puk Leuchten werden zu dem Leuchtenkopf die Gläser/Linsen und optional die Farbfilter separat dazubestellt! Artikelnummern entnehmen Sie bitte der Equipment-Tabelle auf Seite 59.

With the Puk lamps, the glasses, lenses and optional the color filters are ordered separately. Please check the equipment list on page 59 for item numbers.



Puk Floor Maxi, chrome





# Puk Floor Maxi

Stand- und Leseleuchte, Niedervolt Halogen (mit Fußdimmer) oder LED Power (nicht mit Dimmer erhältlich), Köpfe drehbar mit Verstellstift, Arm schwenkbar.

Floor and reading lamp, low voltage halogen (floor dimmer) or LED power (not available with dimmer), heads rotatable with adjusting pin, arm pivoting.



Schwarzer Kopf und Fuß, black head and base



Puk Floor Maxi, chrome

Floor Maxi Single LED	Floor Maxi Single Halogen	Floor Maxi Twin LED	Floor Maxi Twin Halogen	Arm-länge arm length	Gehäuse body
LED: <b>A+</b> 2 x 8W ~1.200lm ~2.800k	GY6.35/QT-LP12: <b>B</b> 1 x 50W IRC ~1.250lm ~2.800k	LED: <b>A+</b> 4 x 8W ~2.400lm ~2.800k	GY6.35/QT-LP12: <b>B</b> 2 x 50W IRC ~2.500lm ~2.800k		
6-081801-1-LED	6-081801-1	6-081801-2-LED	6-081801-2	1.800 mm	chrome matt
6-081802-1-LED	6-081802-1	6-081802-2-LED	6-081802-2	1.800 mm	chrome
6-081803-1-LED	6-081803-1	6-081803-2-LED	6-081803-2	1.800 mm	nickel matt
6-081802-1-W-LED	6-081802-1-W	6-081802-2-W-LED	6-081802-2-W	1.800 mm	white/chrome
6-081802-1-S-LED	6-081802-1-S	6-081802-2-S-LED	6-081802-2-S	1.800 mm	black/chrome
6-081807-1-LED	6-081807-1	6-081807-2-LED	6-081807-2	1.800 mm	anthracite/chrome

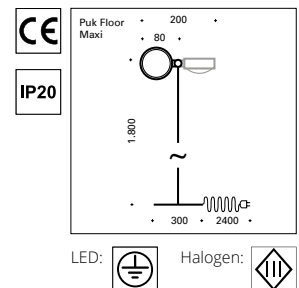

Bei den Puk Leuchten werden zu dem Leuchtenkopf die Gläser/Linsen und optional die Farbfilter separat dazubestellt! Artikelnummern entnehmen Sie bitte der Equipment-Tabelle auf Seite 59.

With the Puk lamps, the glasses, lenses and optional the color filters are ordered separately. Please check the equipment list on page 59 for item numbers.





Puk Floor Mother-Kid, chrome



# Puk Floor Mother-Kid

Stand- und Leseleuchte, Niedervolt Halogen (mit 2 Fußdimmern) oder LED Power (nicht mit Dimmer erhältlich), Köpfe drehbar mit Verstellstift, Arme schwenkbar.

Floor and reading lamp, low voltage halogen (2 floor dimmer) or LED power (not available with dimmer), heads rotatable with adjusting pin, arms pivoting.



Puk Floor Mother-Kid, chrome



Weißer Kopf, white head



Weißer Fuß, white base

Puk Floor Mother-Kid LED	Puk Floor Mother-Kid Halogen	Armlänge arm length	Gehäuse body
LED: <b>A*</b> 6 x 8W ~3.600lm ~2.800k	GY6.35/QT-LP12: <b>B</b> 3 x 50W IRC ~3.750lm ~2.800k		
6-082180120-1-LED	6-082180120-1	1.800 mm + 1.250 mm	chrome matt
6-082180120-2-LED	6-082180120-2	1.800 mm + 1.250 mm	chrome
6-082180120-3-LED	6-082180120-3	1.800 mm + 1.250 mm	nickel matt
6-082180120-2-W-LED	6-082180120-2-W	1.800 mm + 1.250 mm	white/chrome
6-082180120-2-S-LED	6-082180120-2-S	1.800 mm + 1.250 mm	black/chrome
6-082180120-7-LED	6-082180120-7	1.800 mm + 1.250 mm	anthracite/chrome

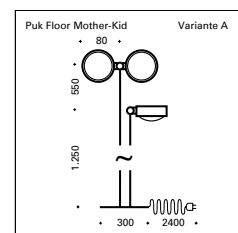

LED:

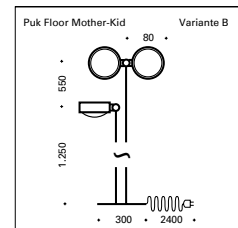

Halogen:



Bei den Puk Leuchten werden zu dem Leuchtenkopf die Gläser/Linsen und optional die Farbfilter separat dazubestellt! Artikelnummern entnehmen Sie bitte der Equipment-Tabelle auf Seite 59.

With the Puk lamps, the glasses, lenses and optional the color filters are ordered separately. Please check the equipment list on page 59 for item numbers.



Puk Plug



Puk Double Wall



Puk Spring



Puk Screw



Puk Fix



Puk Table





# Puk Flexlight

Kombinieren Sie den Puk-Kopf mit Flexarm und Ihrer Wunschbasis, Gläser/Linsen und Farbfilter werden separat dazubestellt.

Combine the Puk head with flexarm and your desired base. Glasses/Lenses and color filters for separate order.

## Basis Artikel-Nr. Base item no.:



Für die gewünschte Basis starten Sie bitte mit der oben aufgeführten Artikelnummer. Spring, Screw & Table nur in Halogen.  
For the right base please start with the item number you see above. Spring, Screw & Table only available in halogen.



Puk Flexlight LED	Puk Flexlight Halogen	Armlänge arm length	Gehäuse body
LED: <b>A+</b> 2 x 8W ~1.200lm ~2.800k	G9/QT14: <b>D</b> 1 x 60W ECO ~980lm ~2.800k		
... 20114-LED ... 20214-LED	... 20114 ... 20214	200 mm 200 mm	chrome nickel matt
... 30114-LED ... 30214-LED	... 30114 ... 30214	300 mm 300 mm	chrome nickel matt
... 40114-LED ... 40214-LED	... 40114 ... 40214	400 mm 400 mm	chrome nickel matt

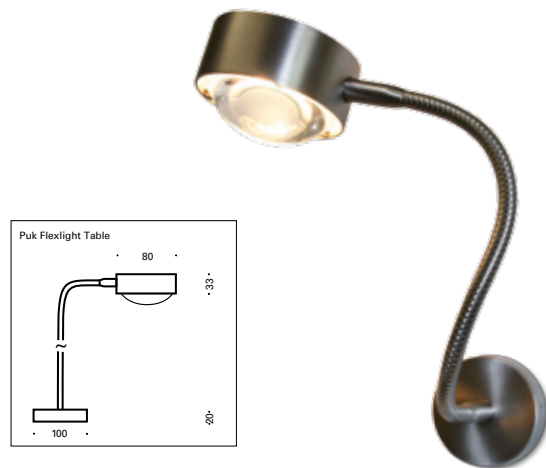

Oben abgebildete Puk Flexlight Wall mit 30 cm Arm in nickelmatt (ohne Linsen/Gläser)\* hat z.B. folgende Art.-Nr.:  
Item no. example for the Puk Flexlight Wall with 30 cm arm in nickel matt (without lens/glass)\* you see above:

**3-4030214**



\*Bei den Puk Leuchten werden zu dem Leuchtenkopf die Gläser/Linsen und optional die Farbfilter separat dazubestellt! Artikelnummern entnehmen Sie bitte der Equipment-Tabelle auf Seite 59.

\*With the Puk lamps, the glasses, lenses and optional the color filters are ordered separately. Please check the equipment list on page 59 for item numbers.





Puk Side Twin, chrome matt



# Puk Equipment

Gläser, Linsen und Farbfilter einzeln dazubestellen  
Order glasses, lenses and color filter separately

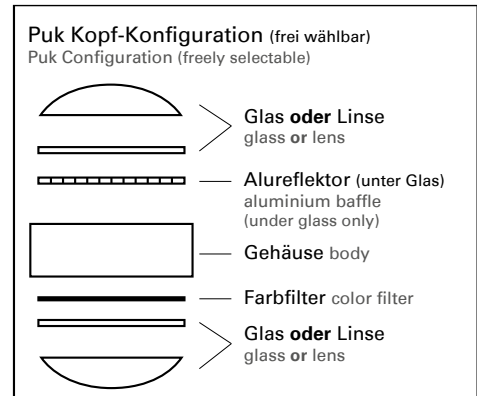

Art. Nr. item no.	Einsatz insert	Beschreibung description
2-2025	Alurefektor, aluminium baffle	Lichtstopp, empfohlen unter Glas lightstop, recommended under glass
2-2026	Linse, lens	klar, clear
2-2026-s	Linse, lens	einseitig mattiert, frosted on one side
2-2027	Glas, glass	beidseitig mattiert, passt nicht unter Linse frosted on both sides, doesn't fit under lens
2-2028	Farbfilter	rot, red
2-2029	empfohlen ohne Glas	magenta, magenta
2-2030	color filter	gelb, yellow
2-2033	recommended	blau, blue
2-2034	without glass	grün, green

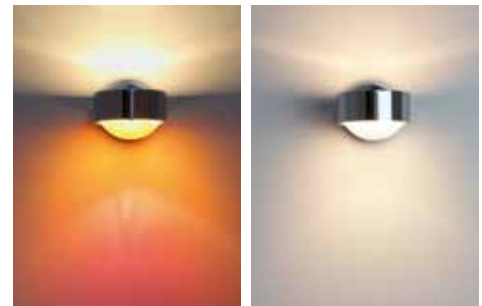

mattierte Linse mit und ohne Farbfilter  
frosted lens with and without color filter

Für 4 Watt LED statt 8 Watt LED bitte **-4** hinter die Artikelnummer hängen, dimmbar  
For a 4 Watt LED instead of 8 Watt LED attach **-4** behind the item number, dimmable



rot red

magenta magenta

gelb yellow

blau blue

grün green

## 1-3 Phasen Adapter - Check In

Für das Eutrac Schienensystem. Montiert auf, 1. Puk Turn (S. 27), 2. Puk Side (S. 29-31), 3. Puk Long One (S. 37), 4. Puk Long Double (S. 37) und 5. Puk Flex (S. 57)! Kürzel hinter die Artikelnummer der Lampe anhängen.

For Eutrac metal rail system. Mounted on Puk Turn (p. 27), Puk Side (p. 29-31), Puk Long One (p. 37), Puk Long Double (p. 37) and Puk Flex (p. 57)! Please attach behind item number of the lamp.

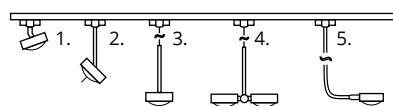

Art. Nr. item no.	Ausführung design
ci1-w	1 Phasen Adapter in weiß, 1 Phase adapter in white
ci1-s	1 Phasen Adapter in silber, 1 Phase adapter in silver
ci3-w	3 Phasen Adapter in weiß, 3 Phase adapter in white
ci3-s	3 Phasen Adapter in silber, 3 Phase adapter in silver





Puk Maxx Wall, chrome





# Puk Maxx

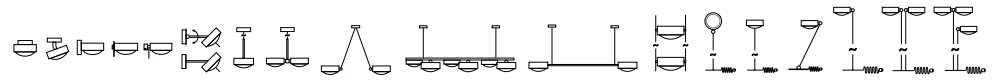

Puk Maxx Wall



Puk Maxx Turn, up- & downlight



Puk Maxx Wall, Farbfilter colorfilter





Puk.Maxx Wall, color filter red



# Puk Maxx Wall

Wandleuchte, LED Power, dimmbar.  
Wall lamp, LED power, dimmable.



Puk Maxx Wall, nickel matt



Puk Maxx Wall, gold



Foto: Bärwolf GmbH & Co. KG

Puk Maxx Wall LED LED: <span style="background-color: green; color: white; padding: 2px;">A+</span> 2 x 12W ~1.800lm ~2.800k	Wandabstand x Höhe wallspace x height	Gehäuse body
2-30811	140 x 80 mm	chrome matt
2-30812	140 x 80 mm	chrome
2-30813	140 x 80 mm	nickel matt
2-30814	140 x 80 mm	white
2-30815	140 x 80 mm	black
2-30816	140 x 80 mm	24 ct gold plated
2-30817	140 x 80 mm	anthracite

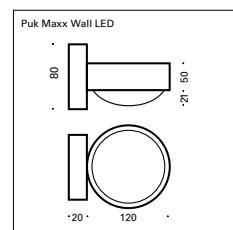

Bei den Puk Maxx Leuchten werden zu dem Leuchtenkopf die Gläser/  
Linsen und optional die Farbfilter separat dazubestellt! Artikelnummern  
entnehmen Sie bitte der Equipment-Tabelle auf Seite 107.

With the Puk Maxx lamps, the glasses, lenses and optional the color filters  
are ordered separately. Please check the equipment list on page 107 for  
item numbers.





# Puk Maxx Wall »+«

Wandleuchte, Hochvolt Halogen oder LED Power, Kopf **drehbar** mit Verstellstift, dimmbar.  
 Wall lamp, high voltage halogen or LED power, head **rotatable** with adjusting pin, dimmable.



Puk Maxx Wall »+«, chrome



Puk Maxx Wall »+«, chrome matt



Puk Maxx Wall »+«, nickel matt

Puk Maxx Wall »+« LED	Puk Maxx Wall »+« Halogen	Wandabstand x Höhe wallspace x height	Gehäuse body
LED: <b>A+</b> 2 x 12W ~1.800lm ~2.800k	G9/QT14: <b>D</b> 2 x 48W ECO ~1.480lm ~2.800k		
2-30801	2-30801-H	150 x 80 mm	chrome matt
2-30802	2-30802-H	150 x 80 mm	chrome
2-30803	2-30803-H	150 x 80 mm	nickel matt
2-30804	2-30804-H	150 x 80 mm	white/chrome
2-30805	2-30805-H	150 x 80 mm	black/chrome
2-30806	2-30806-H	150 x 80 mm	24 ct gold plated/chrome
2-30807	2-30807-H	150 x 80 mm	anthracite/chrome

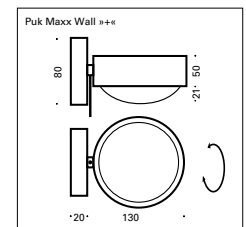

Bei den Puk Maxx Leuchten werden zu dem Leuchtenkopf die Gläser/  
 Linsen und optional die Farbfilter separat dazubestellt! Artikelnummern  
 entnehmen Sie bitte der Equipment-Tabelle auf Seite 107.

With the Puk Maxx lamps, the glasses, lenses and optional the color filters  
 are ordered separately. Please check the equipment list on page 107 for  
 item numbers.







# Puk Maxx Fix & Fix »+«

Spiegelanbauleuchte, Hochvolt Halogen oder LED Power, dimmbar, bei der »+« Variante Kopf drehbar mit Verstellstift.

Mirror mounting lamp, high voltage halogen or LED power, dimmable, »+« model with rotatable and adjusting pin.



Puk Maxx Fix, chrome



Puk Maxx Fix »+«, chrome matt

Puk Maxx Fix LED LED: <b>A*</b> 2 x 12W ~1.800lm ~2.800k	Spiegelabstand x Höhe mirrorspace x height	Puk Maxx Fix »+« LED LED: <b>A*</b> 2 x 12W ~1.800lm ~2.800k	Puk Maxx Fix »+« Halogen G9/QT14: <b>D</b> 2 x 48W ECO ~1.480lm ~2.800k	Spiegelabstand x Höhe mirrorspace x height	Gehäuse body
2-308011	130 x 50 mm	2-308031	2-308031-H	140 x 50 mm	chrome matt
2-308012	130 x 50 mm	2-308032	2-308032-H	140 x 50 mm	chrome
2-308013	130 x 50 mm	2-308033	2-308033-H	140 x 50 mm	nickel matt
2-308014	130 x 50 mm	2-308034	2-308034-H	140 x 50 mm	white/chrome
2-308015	130 x 50 mm	2-308035	2-308035-H	140 x 50 mm	black/chrome
2-308016	130 x 50 mm	2-308036	2-308036-H	140 x 50 mm	24 ct gold plated/chrome
2-308017	130 x 50 mm	2-308037	2-308037-H	140 x 50 mm	anthracite/chrome

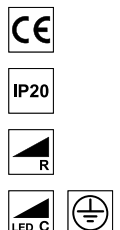
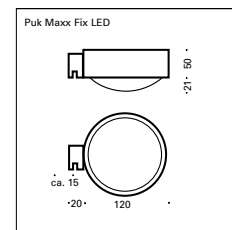
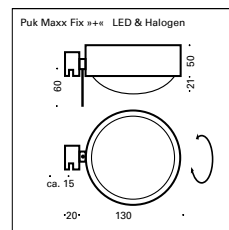

Bei den Puk Maxx Leuchten werden zu dem Leuchtenkopf die Gläser/ Linsen und optional die Farbfilter separat dazubestellt! Artikelnummern entnehmen Sie bitte der Equipment-Tabelle auf Seite 107.

With the Puk Maxx lamps, the glasses, lenses and optional the color filters are ordered separately. Please check the equipment list on page 107 for item numbers.





# Puk Maxx Mirror & Mirror »+«

Spiegeleinbauleuchte, Hochvolt Halogen oder LED Power, dimmbar, bei der »+« Variante Kopf drehbar mit Verstellstift.

Mirror mounting lamp, high voltage halogen or LED power, dimmable, »+« model with rotatable head and adjusting pin.



Puk Maxx Mirror, chrome



Puk Maxx Mirror»+«, nickel matt

Puk Maxx Mirror LED	Puk Maxx Mirror »+« LED	Puk Maxx Mirror »+« Halogen	Spiegelabstand x Höhe mirrorspace x height	Gehäuse body
LED: <b>A+</b> 2 x 12W ~1.800lm ~2.800k	LED: <b>A+</b> 2 x 12W ~1.800lm ~2.800k	G9/QT14: <b>D</b> 2 x 48W ECO ~1.480lm ~2.800k		
2-308211	2-308411	2-308411-H	120/130/145 x 50 mm	chrome matt
2-308212	2-308412	2-308412-H	120/130/145 x 50 mm	chrome
2-308213	2-308413	2-308413-H	120/130/145 x 50 mm	nickel matt
2-308214	2-308414	2-308414-H	120/130/145 x 50 mm	white/chrome
2-308215	2-308415	2-308415-H	120/130/145 x 50 mm	black/chrome
2-308216	2-308416	2-308416-H	120/130/145 x 50 mm	24 ct gold plated/chrome
2-308217	2-308417	2-308417-H	120/130/145 x 50 mm	anthracite/chrome

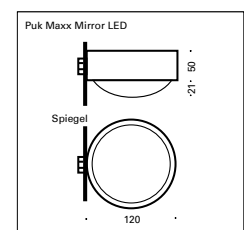
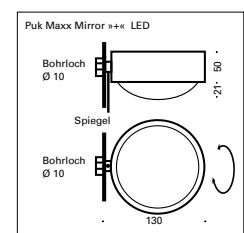

Bei den Puk Maxx Leuchten werden zu dem Leuchtenkopf die Gläser/ Linsen und optional die Farbfilter separat dazubestellt! Artikelnummern entnehmen Sie bitte der Equipment-Tabelle auf Seite 107.

With the Puk Maxx lamps, the glasses, lenses and optional the color filters are ordered separately. Please check the equipment list on page 107 for item numbers.







# Puk Maxx Plus

Wand- und Deckenleuchte, Hochvolt Halogen oder LED Power, dimmbar, Kopf drehbar.  
 Wall and ceiling lamp, high voltage halogen or LED power, dimmable, head rotatable.



Puk Maxx Plus, chrome matt



Puk Maxx Plus, chrome matt

Puk Maxx Plus LED	Puk Maxx Plus Halogen	ø x Höhe ø x height	Gehäuse body
LED: <b>A+</b> 1 x 12W ~900lm ~2.800k	G9/QT14: <b>D</b> 2 x 48W ECO ~1.480lm ~2.800k		
2-3018001	2-3018001-H	120 x 91 mm	chrome matt
2-3018002	2-3018002-H	120 x 91 mm	chrome
2-3018003	2-3018003-H	120 x 91 mm	nickel matt
2-3018004	2-3018004-H	120 x 91 mm	white
2-3018005	2-3018005-H	120 x 91 mm	black
2-3018006	2-3018006-H	120 x 91 mm	24 ct gold plated
2-3018007	2-3018007-H	120 x 91 mm	anthracite

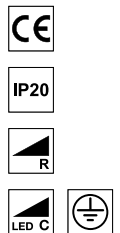
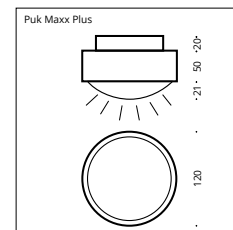

Bei den Puk Maxx Leuchten werden zu dem Leuchtenkopf die Gläser/  
 Linsen und optional die Farbfilter separat dazubestellt! Artikelnummern  
 entnehmen Sie bitte der Equipment-Tabelle auf Seite 107.

With the Puk Maxx lamps, the glasses, lenses and optional the color filters  
 are ordered separately. Please check the equipment list on page 107 for  
 item numbers.







# Puk Maxx Turn

Deckenleuchte, Hochvolt Halogen oder LED Power, dimmbar, Kopf dreh- und schwenkbar.

Ceiling lamp, high voltage halogen or LED power, dimmable, head rotatable and traversable.



Puk Maxx Turn, chrome



Puk Maxx Turn, chrome matt

## Puk Maxx Turn LED downlight

LED: **A+**  
1 x 12W  
~900lm ~2.800k

2-3028001  
2-3028002  
2-3028003  
2-3028004  
2-3028005  
2-3028006  
2-3028007

## Puk Maxx Turn LED up-/downlight

LED: **A+**  
2 x 12W  
~1.800lm ~2.800k

2-3038001  
2-3038002  
2-3038003  
2-3038004  
2-3038005  
2-3038006  
2-3038007

## Puk Maxx Turn Halogen downlight

G9/QT14: **D**  
2 x 48W ECO  
~1.480lm ~2.800k

2-3028001-H  
2-3028002-H  
2-3028003-H  
2-3028004-H  
2-3028005-H  
2-3028006-H  
2-3028007-H

## Puk Maxx Turn Halogen up-/downlight

G9/QT14: **D**  
2 x 48W ECO  
~1.480lm ~2.800k

2-3038001-H  
2-3038002-H  
2-3038003-H  
2-3038004-H  
2-3038005-H  
2-3038006-H  
2-3038007-H

ø x Höhe  
ø x height

120 x 141 mm  
120 x 141 mm  
120 x 141 mm  
120 x 141 mm  
120 x 141 mm  
120 x 141 mm  
120 x 141 mm

Gehäuse  
body

chrome matt  
chrome  
nickel matt  
white/chrome  
black/chrome  
24 ct gold plated/chrome  
anthracite/chrome

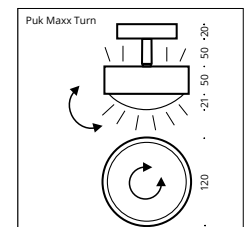

Bei den Puk Maxx Leuchten werden zu dem Leuchtenkopf die Gläser/ Linsen und optional die Farbfilter separat dazubestellt! Artikelnummern entnehmen Sie bitte der Equipment-Tabelle auf Seite 107.

With the Puk Maxx lamps, the glasses, lenses and optional the color filters are ordered separately. Please check the equipment list on page 107 for item numbers.





Puk Maxx Side Single, chrome



# Puk Maxx Side Single

Wand- und Deckenleuchte mit Arm, Hochvolt Halogen oder LED Power, Kopf drehbar.

Wall and ceiling lamp with arm, high voltage halogen or LED power, head rotatable.



Puk Maxx Side Single, chrome



Puk Maxx Side Single, nickel matt

Wand Wall	Puk Maxx Side Single LED	Puk Maxx Side Single Halogen	Maße Armlänge arm length	Gehäuse body
	LED: <b>A+</b> 2 x 12W ~1.800lm ~2.800k	G9/QT14: <b>D</b> 2 x 48W ECO ~1.480lm ~2.800k		
2-30821	2-30821-H	100 mm	chrome matt	
2-30822	2-30822-H	100 mm	chrome	
2-30823	2-30823-H	100 mm	nickel matt	
2-30824	2-30824-H	100 mm	white/chrome	
2-30825	2-30825-H	100 mm	black/chrome	
2-30827	2-30827-H	100 mm	anthracite/chrome	
2-30831	2-30831-H	200 mm	chrome matt	
2-30832	2-30832-H	200 mm	chrome	
2-30833	2-30833-H	200 mm	nickel matt	
2-30834	2-30834-H	200 mm	white/chrome	
2-30835	2-30835-H	200 mm	black/chrome	
2-30837	2-30837-H	200 mm	anthracite/chrome	
2-30861	2-30861-H	300 mm	chrome matt	
2-30862	2-30862-H	300 mm	chrome	
2-30863	2-30863-H	300 mm	nickel matt	
2-30864	2-30864-H	300 mm	white/chrome	
2-30865	2-30865-H	300 mm	black/chrome	
2-30867	2-30867-H	300 mm	anthracite/chrome	

Decke Ceiling	Puk Maxx Side Single LED	Puk Maxx Side Single Halogen	Maße Armlänge arm length	Gehäuse body
	LED: <b>A+</b> 2 x 12W ~1.800lm ~2.800k	G9/QT14: <b>D</b> 2 x 48W ECO ~1.480lm ~2.800k		
2-30871	2-30871-H	400 mm	chrome matt	
2-30872	2-30872-H	400 mm	chrome	
2-30873	2-30873-H	400 mm	nickel matt	
2-30874	2-30874-H	400 mm	white/chrome	
2-30875	2-30875-H	400 mm	black/chrome	
2-30877	2-30877-H	400 mm	anthracite/chrome	
2-30881	2-30881-H	600 mm	chrome matt	
2-30882	2-30882-H	600 mm	chrome	
2-30883	2-30883-H	600 mm	nickel matt	
2-30884	2-30884-H	600 mm	white/chrome	
2-30885	2-30885-H	600 mm	black/chrome	
2-30887	2-30887-H	600 mm	anthracite/chrome	

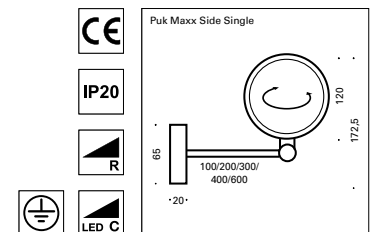

Bei den Puk Maxx Leuchten werden zu dem Leuchtenkopf die Gläser/ Linsen und optional die Farbfilter separat dazubestellt! Artikelnummern entnehmen Sie bitte der Equipment-Tabelle auf Seite 107.

With the Puk Maxx lamps, the glasses, lenses and optional the color filters are ordered separately. Please check the equipment list on page 107 for item numbers.



Puk Maxx Side Twin, chrome



# Puk Maxx Side Twin

Wand- und Deckenleuchte mit Arm, Hochvolt Halogen oder LED Power, Köpfe drehbar.

Wall and ceiling lamp with arm, high voltage halogen or LED power, heads rotatable.



Puk Maxx Side Single, chrome



Puk Maxx Side Twin, chrome

	Puk Maxx Side Twin LED	Puk Maxx Side Twin Halogen	Maße Armlänge arm length	Gehäuse body
	LED: <b>A*</b> 4 x 12W ~3.600lm ~2.800k	G9/QT14: <b>D</b> 4 x 48W ECO ~2.960lm ~2.800k		
Wand Wall	2-30841	2-30841-H	100 mm	chrome matt
	2-30842	2-30842-H	100 mm	chrome
	2-30843	2-30843-H	100 mm	nickel matt
	2-30844	2-30844-H	100 mm	white/chrome
	2-30845	2-30845-H	100 mm	black/chrome
	2-30847	2-30847-H	100 mm	anthracite/chrome
	2-30851	2-30851-H	200 mm	chrome matt
	2-30852	2-30852-H	200 mm	chrome
	2-30853	2-30853-H	200 mm	nickel matt
	2-30854	2-30854-H	200 mm	white/chrome
	2-30855	2-30855-H	200 mm	black/chrome
	2-30857	2-30857-H	200 mm	anthracite/chrome
	2-30891	2-30891-H	300 mm	chrome matt
	2-30892	2-30892-H	300 mm	chrome
2-30893	2-30893-H	300 mm	nickel matt	
2-30894	2-30894-H	300 mm	white/chrome	
2-30895	2-30895-H	300 mm	black/chrome	
2-30897	2-30897-H	300 mm	anthracite/chrome	

	Puk Maxx Side Twin LED	Puk Maxx Side Twin Halogen	Maße Armlänge arm length	Gehäuse body
	LED: <b>A*</b> 4 x 12W ~3.600lm ~2.800k	G9/QT14: <b>D</b> 4 x 48W ECO ~2.960lm ~2.800k		
Decke Ceiling	2-308101	2-308101-H	400 mm	chrome matt
	2-308102	2-308102-H	400 mm	chrome
	2-308103	2-308103-H	400 mm	nickel matt
	2-308104	2-308104-H	400 mm	white/chrome
	2-308105	2-308105-H	400 mm	black/chrome
	2-308107	2-308107-H	400 mm	anthracite/chrome
	2-308111	2-308111-H	600 mm	chrome matt
	2-308112	2-308112-H	600 mm	chrome
	2-308113	2-308113-H	600 mm	nickel matt
	2-308114	2-308114-H	600 mm	white/chrome
	2-308115	2-308115-H	600 mm	black/chrome
	2-308117	2-308117-H	600 mm	anthracite/chrome

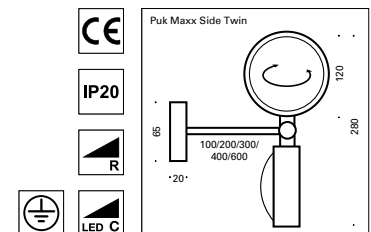

Bei den Puk Maxx Leuchten werden zu dem Leuchtenkopf die Gläser/ Linsen und optional die Farbfilter separat dazubestellt! Artikelnummern entnehmen Sie bitte der Equipment-Tabelle auf Seite 107.

With the Puk Maxx lamps, the glasses, lenses and optional the color filters are ordered separately. Please check the equipment list on page 107 for item numbers.







# Puk Maxx Wing Single

Wand- und Deckenleuchte mit schwenkbarem Arm, Hochvolt Halogen oder LED Power, Kopf drehbar.

Wall and ceiling lamp with adjustable arm, high voltage halogen or LED power, head rotatable.



Puk Maxx Wing Single, chrome matt



Puk Maxx Wing Single, chrome

	Puk Maxx Wing Single LED	Puk Maxx Wing Single Halogen	Armlänge arm length	Gehäuse body
	LED: <b>A*</b> 2 x 12W ~1.800lm ~2.800k	G9/QT14: <b>D</b> 2 x 48W ECO ~1.480lm ~2.800k		
Wand Wall	2-38201	2-38201-H	200 mm	chrome matt
	2-38202	2-38202-H	200 mm	chrome
	2-38203	2-38203-H	200 mm	nickel matt
	2-38204	2-38204-H	200 mm	white/chrome
	2-38205	2-38205-H	200 mm	black/chrome
	2-38207	2-38207-H	200 mm	anthracite/chrome
	2-38301	2-38301-H	300 mm	chrome matt
2-38302	2-38302-H	300 mm	chrome	
2-38303	2-38303-H	300 mm	nickel matt	
2-38304	2-38304-H	300 mm	white/chrome	
2-38305	2-38305-H	300 mm	black/chrome	
2-38307	2-38307-H	300 mm	anthracite/chrome	

	Puk Maxx Wing Single LED	Puk Maxx Wing Single Halogen	Armlänge arm length	Gehäuse body
	LED: <b>A*</b> 2 x 12W ~1.800lm ~2.800k	G9/QT14: <b>D</b> 2 x 48W ECO ~1.480lm ~2.800k		
Decke Ceiling	2-38401	2-38401-H	400 mm	chrome matt
	2-38402	2-38402-H	400 mm	chrome
	2-38403	2-38403-H	400 mm	nickel matt
	2-38404	2-38404-H	400 mm	white/chrome
	2-38405	2-38405-H	400 mm	black/chrome
	2-38407	2-38407-H	400 mm	anthracite/chrome
	2-38601	2-38601-H	600 mm	chrome matt
	2-38602	2-38602-H	600 mm	chrome
	2-38603	2-38603-H	600 mm	nickel matt
	2-38604	2-38604-H	600 mm	white/chrome
	2-38605	2-38605-H	600 mm	black/chrome
	2-38607	2-38607-H	600 mm	anthracite/chrome
	2-38801	2-38801-H	800 mm	chrome matt
	2-38802	2-38802-H	800 mm	chrome
	2-38803	2-38803-H	800 mm	nickel matt
	2-38804	2-38804-H	800 mm	white/chrome
	2-38805	2-38805-H	800 mm	black/chrome
	2-38807	2-38807-H	800 mm	anthracite/chrome
	2-381001	2-381001-H	1.000 mm	chrome matt
	2-381002	2-381002-H	1.000 mm	chrome
	2-381003	2-381003-H	1.000 mm	nickel matt
2-381004	2-381004-H	1.000 mm	white/chrome	
2-381005	2-381005-H	1.000 mm	black/chrome	
2-381007	2-381007-H	1.000 mm	anthracite/chrome	
2-381201	2-381201-H	1.250 mm	chrome matt	
2-381202	2-381202-H	1.250 mm	chrome	
2-381203	2-381203-H	1.250 mm	nickel matt	
2-381204	2-381204-H	1.250 mm	white/chrome	
2-381205	2-381205-H	1.250 mm	black/chrome	
2-381207	2-381207-H	1.250 mm	anthracite/chrome	

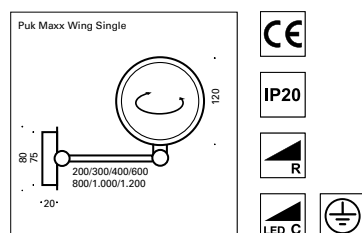

Bei den Puk Maxx Leuchten werden zu dem Leuchtenkopf die Gläser/Linsen und optional die Farbfilter separat dazubestellt! Artikelnummern entnehmen Sie bitte der Equipment-Tabelle auf Seite 107.

With the Puk Maxx lamps, the glasses, lenses and optional the color filters are ordered separately. Please check the equipment list on page 107 for item numbers.



Puk Maxx Wing Twin, chrome



# Puk Maxx Wing Twin

Wand- und Deckenleuchte mit schwenkbarem Arm, Hochvolt Halogen oder LED Power, Köpfe drehbar.

Wall and ceiling lamp with adjustable arm, high voltage halogen or LED power, heads rotatable.



Puk Maxx Wing Single, chrome matt



Puk Maxx Wing Twin, chrome

	Puk Maxx Wing Twin LED	Puk Maxx Wing Twin Halogen	Armlänge arm length	Gehäuse body
	LED: <b>A*</b> 4 x 12W ~3.600lm ~2.800k	G9/QT14: <b>D</b> 4 x 48W ECO ~2.960lm ~2.800k		
Wand Wall	2-39201	2-39201-H	200 mm	chrome matt
	2-39202	2-39202-H	200 mm	chrome
	2-39203	2-39203-H	200 mm	nickel matt
	2-39204	2-39204-H	200 mm	white/chrome
	2-39205	2-39205-H	200 mm	black/chrome
	2-39207	2-39207-H	200 mm	anthracite/chrome
	2-39301	2-39301-H	300 mm	chrome matt
2-39302	2-39302-H	300 mm	chrome	
2-39303	2-39303-H	300 mm	nickel matt	
2-39304	2-39304-H	300 mm	white/chrome	
2-39305	2-39305-H	300 mm	black/chrome	
2-39307	2-39307-H	300 mm	anthracite/chrome	

	Puk Maxx Wing Twin LED	Puk Maxx Wing Twin Halogen	Armlänge arm length	Gehäuse body
	LED: <b>A*</b> 4 x 12W ~3.600lm ~2.800k	G9/QT14: <b>D</b> 4 x 48W ECO ~2.960lm ~2.800k		
Decke Ceiling	2-39401	2-39401-H	400 mm	chrome matt
	2-39402	2-39402-H	400 mm	chrome
	2-39403	2-39403-H	400 mm	nickel matt
	2-39404	2-39404-H	400 mm	white/chrome
	2-39405	2-39405-H	400 mm	black/chrome
	2-39407	2-39407-H	400 mm	anthracite/chrome
	2-39601	2-39601-H	600 mm	chrome matt
	2-39602	2-39602-H	600 mm	chrome
	2-39603	2-39603-H	600 mm	nickel matt
	2-39604	2-39604-H	600 mm	white/chrome
	2-39605	2-39605-H	600 mm	black/chrome
	2-39607	2-39607-H	600 mm	anthracite/chrome
	2-39801	2-39801-H	800 mm	chrome matt
	2-39802	2-39802-H	800 mm	chrome
	2-39803	2-39803-H	800 mm	nickel matt
	2-39804	2-39804-H	800 mm	white/chrome
	2-39805	2-39805-H	800 mm	black/chrome
	2-39807	2-39807-H	800 mm	anthracite/chrome
	2-391001	2-391001-H	1.000 mm	chrome matt
	2-391002	2-391002-H	1.000 mm	chrome
	2-391003	2-391003-H	1.000 mm	nickel matt
2-391004	2-391004-H	1.000 mm	white/chrome	
2-391005	2-391005-H	1.000 mm	black/chrome	
2-391007	2-391007-H	1.000 mm	anthracite/chrome	
2-391201	2-391201-H	1.250 mm	chrome matt	
2-391202	2-391202-H	1.250 mm	chrome	
2-391203	2-391203-H	1.250 mm	nickel matt	
2-391204	2-391204-H	1.250 mm	white/chrome	
2-391205	2-391205-H	1.250 mm	black/chrome	
2-391207	2-391207-H	1.250 mm	anthracite/chrome	

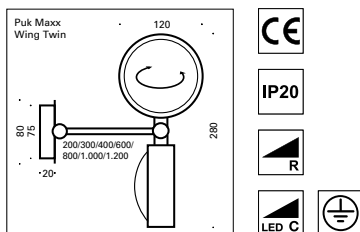

Bei den Puk Maxx Leuchten werden zu dem Leuchtenkopf die Gläser/ Linsen und optional die Farbfilter separat dazubestellt! Artikelnummern entnehmen Sie bitte der Equipment-Tabelle auf Seite 107.

With the Puk Maxx lamps, the glasses, lenses and optional the color filters are ordered separately. Please check the equipment list on page 107 for item numbers.





Puk Maxx Long One, chrome matt



# Puk Maxx Long One & Long Double

Pendelleuchte, Hochvolt Halogen oder LED Power, mit ein oder zwei Köpfen dimmbar.  
Pendant lamp, high voltage halogen or LED power, with one or two heads, dimmable.



Puk Maxx Long One, chrome matt



Puk Maxx Long Double, chrome matt

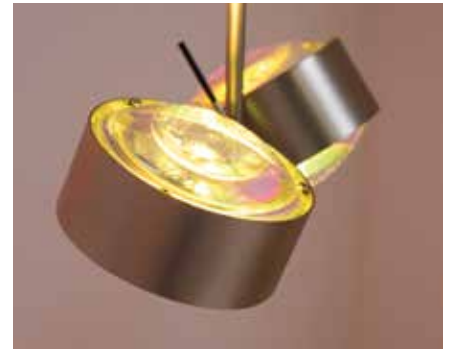

Puk Maxx Long Double, chrome matt

Puk Maxx LED LED: <span style="color: green;">A+</span> ~2.800k	Puk Maxx Halogen G9/QT14: <span style="color: orange;">D</span> ~1.480lm & 2.960lm	Pendellänge x B pendular length x w	Gehäuse body
<b>Long One</b> 1 x 12W ~900lm	<b>Long One</b> 2 x 48W ECO ~2.800k		
5-38001	5-38001-H	1.300 x 120 mm	chrome matt
5-38002	5-38002-H	1.300 x 120 mm	chrome
5-38003	5-38003-H	1.300 x 120 mm	nickel matt
5-38004	5-38004-H	1.300 x 120 mm	white/chrome
5-38005	5-38005-H	1.300 x 120 mm	black/chrome
5-38006	5-38006-H	1.300 x 120 mm	24 carat gold plated/chrome
5-38007	5-38007-H	1.300 x 120 mm	anthracite/chrome
<b>Long Double</b> 4 x 12W ~3.600lm	<b>Long Double</b> 4 x 48W ECO ~2.800k		
5-38021	5-38021-H	1.300 x 280 mm	chrome matt
5-38022	5-38022-H	1.300 x 280 mm	chrome
5-38023	5-38023-H	1.300 x 280 mm	nickel matt
5-38024	5-38024-H	1.300 x 280 mm	white/chrome
5-38025	5-38025-H	1.300 x 280 mm	black/chrome
5-38026	5-38026-H	1.300 x 280 mm	24 carat gold plated/chrome
5-38027	5-38027-H	1.300 x 280 mm	anthracite/chrome

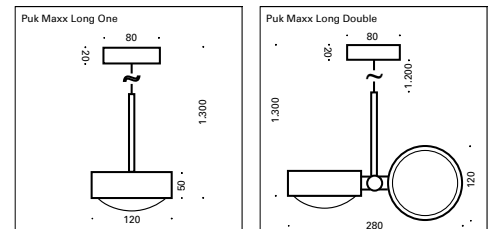

Bei den Puk Maxx Leuchten werden zu dem Leuchtenkopf die Gläser/ Linsen und optional die Farbfilter separat dazubestellt! Artikelnummern entnehmen Sie bitte der Equipment-Tabelle auf Seite 107.

With the Puk Maxx lamps, the glasses, lenses and optional the color filters are ordered separately. Please check the equipment list on page 107 for item numbers.



Puk Maxx Ceiling Sister Single, chrome



# Puk Maxx Ceiling Sister Single

Deckenleuchte, Hochvolt Halogen oder LED Power, dimmbar, Köpfe drehbar, Arme schwenkbar.  
Ceiling lamp, high voltage halogen or LED power, dimmable, heads rotatable, arms pivoting.



Puk Maxx Ceiling Sister Single, chrome

Puk Maxx Ceiling Sister LED LED: <b>A*</b> 4 x 12W ~3.600lm ~2.800k	Puk Maxx Ceiling Sister Halogen Halogen G9/QT14: <b>D</b> 4 x 48W ECO ~2.960lm ~2.800k	Arm Länge arm length	Gehäuse body
5-381201-2	5-381201-2-H	200 mm	chrome matt
5-381202-2	5-381202-2-H	200 mm	chrome
5-381203-2	5-381203-2-H	200 mm	nickel matt
5-381204-2	5-381204-2-H	200 mm	white/chrome
5-381205-2	5-381205-2-H	200 mm	black/chrome
5-381207-2	5-381207-2-H	200 mm	anthracite/chrome
5-381401-2	5-381401-2-H	400 mm	chrome matt
5-381402-2	5-381402-2-H	400 mm	chrome
5-381403-2	5-381403-2-H	400 mm	nickel matt
5-381404-2	5-381404-2-H	400 mm	white/chrome
5-381405-2	5-381405-2-H	400 mm	black/chrome
5-381407-2	5-381407-2-H	400 mm	anthracite/chrome
5-381601-2	5-381601-2-H	600 mm	chrome matt
5-381602-2	5-381602-2-H	600 mm	chrome
5-381603-2	5-381603-2-H	600 mm	nickel matt
5-381604-2	5-381604-2-H	600 mm	white/chrome
5-381605-2	5-381605-2-H	600 mm	black/chrome
5-381607-2	5-381607-2-H	600 mm	anthracite/chrome
5-381801-2	5-381801-2-H	800 mm	chrome matt
5-381802-2	5-381802-2-H	800 mm	chrome
5-381803-2	5-381803-2-H	800 mm	nickel matt
5-381804-2	5-381804-2-H	800 mm	white/chrome
5-381805-2	5-381805-2-H	800 mm	black/chrome
5-381807-2	5-381807-2-H	800 mm	anthracite/chrome
5-3811001-2	5-3811001-2-H	1.000 mm	chrome matt
5-3811002-2	5-3811002-2-H	1.000 mm	chrome
5-3811003-2	5-3811003-2-H	1.000 mm	nickel matt
5-3811004-2	5-3811004-2-H	1.000 mm	white/chrome
5-3811005-2	5-3811005-2-H	1.000 mm	black/chrome
5-3811007-2	5-3811007-2-H	1.000 mm	anthracite/chrome
5-3811201-2	5-3811201-2-H	1.250 mm	chrome matt
5-3811202-2	5-3811202-2-H	1.250 mm	chrome
5-3811203-2	5-3811203-2-H	1.250 mm	nickel matt
5-3811204-2	5-3811204-2-H	1.250 mm	white/chrome
5-3811205-2	5-3811205-2-H	1.250 mm	black/chrome
5-3811207-2	5-3811207-2-H	1.250 mm	anthracite/chrome

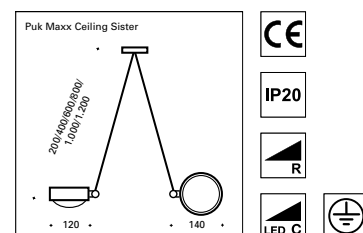

Bei den Puk Maxx Leuchten werden zu dem Leuchtenkopf die Gläser/ Linsen und optional die Farbfilter separat dazubestellt! Artikelnummern entnehmen Sie bitte der Equipment-Tabelle auf Seite 107.

With the Puk Maxx lamps, the glasses, lenses and optional the color filters are ordered separately. Please check the equipment list on page 107 for item numbers.





Puk Maxx Bone, chrome



# Puk Maxx Bone

Pendelleuchte mit zwei drehbaren Köpfen, Hochvolt Halogen oder LED Power.  
 Pendant lamp with two rotatable heads, high voltage halogen or LED power.



Beide Aufhängungen möglich, da das Zubehör im Lieferumfang enthalten ist. Pendellänge stufenlos einstellbar.



Both suspensions possible. The equipment for mounting is included in the delivery. Pendular length adjustable.



Puk Maxx Bone, chrome



Puk Maxx LED, Detail

Puk Maxx Bone LED	Puk Maxx Bone Halogen	Pendellänge x L pendular length x l	Gehäuse body
LED: <b>A</b> 4 x 12W ~3.600lm ~2.800k	G9/QT14: <b>D</b> 4 x 48W ECO ~2.960lm ~2.800k		
5-38101	5-38101-H	2.000 x 1.000 mm	chrome matt
5-38102	5-38102-H	2.000 x 1.000 mm	chrome
5-38103	5-38103-H	2.000 x 1.000 mm	nickel matt
5-38104	5-38104-H	2.000 x 1.000 mm	white/chrome
5-38105	5-38105-H	2.000 x 1.000 mm	black/chrome
5-38107	5-38107-H	2.000 x 1.000 mm	anthracite/chrome

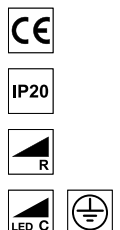
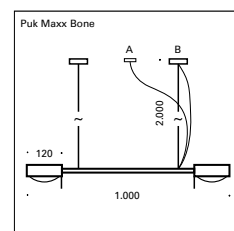

Bei den Puk Maxx Leuchten werden zu dem Leuchtenkopf die Gläser/ Linsen und optional die Farbfilter separat dazubestellt! Artikelnummern entnehmen Sie bitte der Equipment-Tabelle auf Seite 107.

With the Puk Maxx lamps, the glasses, lenses and optional the color filters are ordered separately. Please check the equipment list on page 107 for item numbers.





Puk Maxx Sixtett chrome matt



# Puk Maxx Quartett & Sixtett

Pendelleuchte mit drehbaren Köpfen bei Halogen Variante, Hochvolt Halogen oder LED Power.

Pendant lamp with rotatable heads at halogen variant, high voltage halogen or LED power.



Puk Maxx Quartett, chrome matt



Beide Aufhängungen möglich, da das Zubehör im Lieferumfang enthalten ist. Pendellänge stufenlos einstellbar.

Both suspensions possible. The equipment for mounting is included in the delivery. Pendular length adjustable.

Puk Maxx LED LED: <b>A+</b> ~2.800k	Puk Maxx Halogen G9/QT14: <b>D</b> ~2.800k ~5.920lm & 8.880lm	Pendellänge x L pendular length x l	Gehäuse body
<b>Quartett</b> 8 x 12W ~7.200lm 5-38801-4 5-38802-4 5-38803-4 5-38804-4 5-38805-4 5-38807-4	<b>Quartett</b> 8 x 48W ECO 5-38801-4-H 5-38802-4-H 5-38803-4-H 5-38804-4-H 5-38805-4-H 5-38807-4-H	2.000 x 805 mm 2.000 x 805 mm 2.000 x 805 mm 2.000 x 805 mm 2.000 x 805 mm 2.000 x 805 mm	chrome matt chrome nickel matt white/chrome black/chrome anthracite/chrome
<b>Sixtett</b> 12 x 12W ~10.800lm 5-381201-6 5-381202-6 5-381203-6 5-381204-6 5-381205-6 5-381207-6	<b>Sixtett</b> 12 x 48W ECO 5-381201-6-H 5-381202-6-H 5-381203-6-H 5-381204-6-H 5-381205-6-H 5-381207-6-H	2.000 x 1.260 mm 2.000 x 1.260 mm 2.000 x 1.260 mm 2.000 x 1.260 mm 2.000 x 1.260 mm 2.000 x 1.260 mm	chrome matt chrome nickel matt white/chrome black/chrome anthracite/chrome

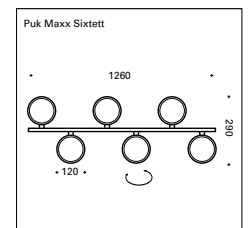
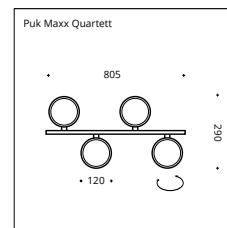

Bei den Puk Maxx Leuchten werden zu dem Leuchtenkopf die Gläser/ Linsen und optional die Farbfilter separat dazubestellt! Artikelnummern entnehmen Sie bitte der Equipment-Tabelle auf Seite 107.

With the Puk Maxx lamps, the glasses, lenses and optional the color filters are ordered separately. Please check the equipment list on page 107 for item numbers.



# Tri Star als Systemleuchte Tri Star as lighting system



**Deckentrafo**  
Ceiling transformer  
200 VA, 150 W

Art.-Nr. item-no.	Gehäuse o. Seil body without rope
5-38610	chrome matt
5-38620	chrome
5-38630	nickel matt
5-38640	white
5-38650	black
5-38670	anthracite



**Endgewicht für System mit Deckentrafo**  
Final weight for the ceiling transformer system

Art.-Nr. item-no.	Gehäuse o. Seil body without rope
5-38615	chrome matt
5-38625	chrome
5-38635	nickel matt
5-38645	white
5-38655	black
5-38675	anthracite

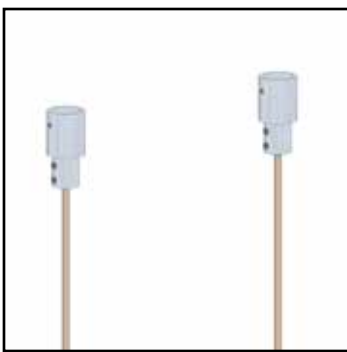

**Befestigungsset Decke**  
Fixing for the ceiling

Art.-Nr. item-no.	Befestigung o. Seil fixing without rope
5-38611	chrome matt
5-38621	chrome
5-38631	nickel matt

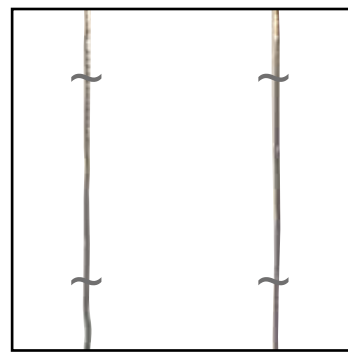

**Seil Cu-Leiter verzinkt mit Kevlar**  
Tinned rope Cu conductor with Kevlar

Art.-Nr. item-no.	Einheit pro unit per
5-38609	1 m

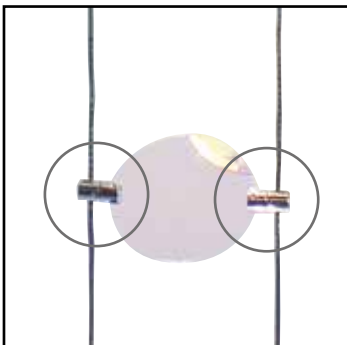

**Halter für Disc, Farbfilter oder Glas (Seite 107)**  
Holder for disc, color filter or glass (page 107)

Art.-Nr. item-no.	Halter ohne Disc holder without Disc
5-38612	chrome matt
5-38622	chrome
5-38632	nickel matt

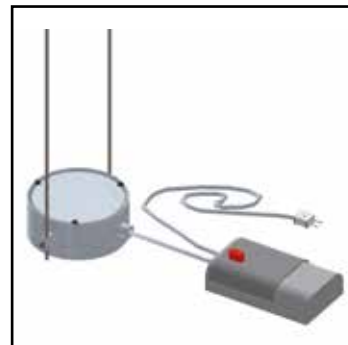

**Bodeneinspeisung mit Trafo-dimmer und Stecker für Befestigungsset Decke 200W**  
Floor transformer with dimmer and plug for ceiling fixing 200 W

Art.-Nr. item-no.	Gehäuse o. Seil body without rope
5-38614	chrome matt
5-38624	chrome
5-38634	nickel matt
5-38644	white
5-38654	black
5-38674	anthracite



**Puk Maxx Kopf mit integriertem Halter**  
Puk Maxx head with integrated holder

Art.-Nr. item-no.	Gehäuse o. Linsen/Gläser body without lens/glass
5-38613	chrome matt
5-38623	chrome
5-38633	nickel matt
5-38643	white
5-38653	black
5-38673	anthracite

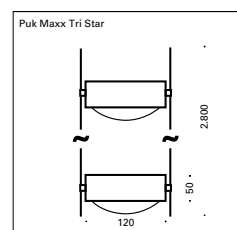

Puk Maxx Kopf ist ohne Zubehör. Disc, Gläser, Linsen und Farbfilter müssen separat dazubestellt werden. (Seite 107)

Puk Maxx head will be delivered without equipment parts. Disc, glasses, lenses and color filters are ordered separately. (Page 107)



# Puk Maxx Tri Star

Vertikal hängende Pendelleuchte mit Reflektoren. Als fertiges System oder individuell zusammenstellbar. In Nieder-volt Halogen, dimmbar.

Vertical Pendant lamp with baffles. Available as a complete system or individually configurable. In low voltage halogen, dimmable.

Puk Maxx Tri Star Halogen GY6.35/QT-LP12: <b>B</b> ~2.800k	Pendellänge pendular length	Gehäuse body
<b>2-fach Deckenanschl. (Abb. A)</b>		
5-382601-2 2 x 50W IRC, ~2.500lm	2.800 mm	chrome matt
5-382602-2 2 x 50W IRC, ~2.500lm	2.800 mm	chrome
5-382603-2 2 x 50W IRC, ~2.500lm	2.800 mm	nickel matt
5-382604-2 2 x 50W IRC, ~2.500lm	2.800 mm	white/chrome
5-382605-2 2 x 50W IRC, ~2.500lm	2.800 mm	black/chrome
5-382607-2 2 x 50W IRC, ~2.500lm	2.800 mm	anthracite/chrome
<b>2-fach Bodenanschl. (Abb. B)</b>		
5-382601-2B 2 x 50W IRC, ~2.500lm	2.800 mm	chrome matt
5-382602-2B 2 x 50W IRC, ~2.500lm	2.800 mm	chrome
5-382603-2B 2 x 50W IRC, ~2.500lm	2.800 mm	nickel matt
5-382604-2B 2 x 50W IRC, ~2.500lm	2.800 mm	white/chrome
5-382605-2B 2 x 50W IRC, ~2.500lm	2.800 mm	black/chrome
5-382607-2B 2 x 50W IRC, ~2.500lm	2.800 mm	anthracite/chrome
<b>3-fach Deckenanschl. (Abb. C)</b>		
5-382601-3 3 x 50W IRC, ~3.750lm	2.800 mm	chrome
5-382602-3 3 x 50W IRC, ~3.750lm	2.800 mm	chrome matt
5-382603-3 3 x 50W IRC, ~3.750lm	2.800 mm	nickel matt
5-382604-3 3 x 50W IRC, ~3.750lm	2.800 mm	white/chrome
5-382605-3 3 x 50W IRC, ~3.750lm	2.800 mm	black/chrome
5-382607-3 3 x 50W IRC, ~3.750lm	2.800 mm	anthracite/chrome
<b>3-fach Bodenanschl. (Abb. D)</b>		
5-382601-3B 3 x 50W IRC, ~3.750lm	2.800 mm	chrome
5-382602-3B 3 x 50W IRC, ~3.750lm	2.800 mm	chrome matt
5-382603-3B 3 x 50W IRC, ~3.750lm	2.800 mm	nickel matt
5-382604-3B 3 x 50W IRC, ~3.750lm	2.800 mm	white/chrome
5-382605-3B 3 x 50W IRC, ~3.750lm	2.800 mm	black/chrome
5-382607-3B 3 x 50W IRC, ~3.750lm	2.800 mm	anthracite/chrome

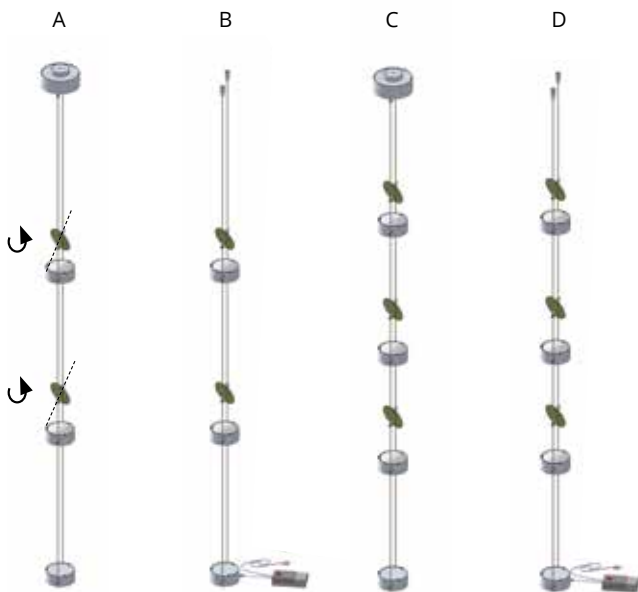

Zubehörteile Disc, Gläser, Linsen und Farfilter müssen separat dazubestellt werden. (Seite 107)

Equipment parts disc, glasses, lenses and color filters are ordered separately. (Page 107)

Bei den Puk Maxx Leuchten werden zu dem Leuchtenkopf die Gläser/ Linsen und optional die Farfilter separat dazubestellt! Artikelnummern entnehmen Sie bitte der Equipment-Tabelle auf Seite 107.

With the Puk Maxx lamps, the glasses, lenses and optional the color filters are ordered separately. Please check the equipment list on page 107 for item numbers.







# Puk Maxx Mike

Stehleuchte mit senkrechtem Leuchtenkopf, Filterfarbe ändert sich mit dem Sichtwinkel. Niedervolt Halogen (mit Dimmer) oder LED Power (nur mit Schalter).

Floor lamp with a vertical head, the color of the filter changes with a different viewing angle. Low voltage halogen (with dimmer) or LED power (only with switch).



Puk Maxx Mike chrome



Puk Maxx Mike chrome



Puk Maxx Mike chrome



Puk Maxx Mike chrome



Puk Maxx Mike chrome



Puk Maxx Mike FarbfILTER colorfilter

Puk Maxx Mike Table LED	Puk Maxx Mike Table Halogen	Höhe height	Puk Maxx Mike Floor LED	Puk Maxx Mike Floor Halogen	Höhe height	Gehäuse body
LED: <b>A*</b> 2 x 12W ~1.800lm ~2.800k	GY6.35/QT-LP12: <b>B</b> 1 x 50W IRC ~1.250lm ~2.800k		LED: <b>A*</b> 2 x 12W ~1.800lm ~2.800k	GY6.35/QT-LP12: <b>B</b> 1 x 50W IRC ~1.250lm ~2.800k		
6-385201	6-385201-H	520 mm	6-3813701	6-3813701-H	1.370 mm	chrome matt
6-385202	6-385202-H	520 mm	6-3813702	6-3813702-H	1.370 mm	chrome
6-385203	6-385203-H	520 mm	6-3813703	6-3813703-H	1.370 mm	nickel matt
6-385204	6-385204-H	520 mm	6-3813704	6-3813704-H	1.370 mm	white/chrome
6-385205	6-385205-H	520 mm	6-3813705	6-3813705-H	1.370 mm	black/chrome
6-385207	6-385207-H	520 mm	6-3813707	6-3813707-H	1.370 mm	anthracite/chrome

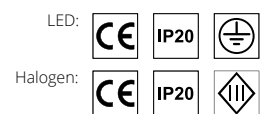
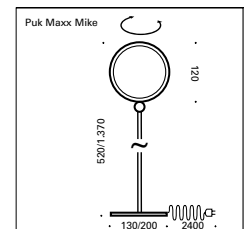

Bei den Puk Maxx Leuchten werden zu dem Leuchtenkopf die Gläser/ Linsen und optional die FarbfILTER separat dazubestellt! Artikelnummern entnehmen Sie bitte der Equipment-Tabelle auf Seite 107.

With the Puk Maxx lamps, the glasses, lenses and optional the color filters are ordered separately. Please check the equipment list on page 107 for item numbers.





Puk Maxx Eye Table, chrome



# Puk Maxx Eye Table & Floor

Tisch- oder Stehleuchte mit fester Linse, Niedervolt Halogen (mit Dimmer) oder LED Power (nur mit Schalter).

Table or floor lamp with fixed lens, low voltage halogen (with dimmer) or LED power (only with switch).



Puk Maxx Eye Table, white/chrome



Puk Maxx Eye Table, black/chrome



Puk Maxx Eye, chrome



Puk Maxx Eye Floor, chrome

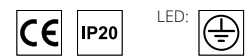
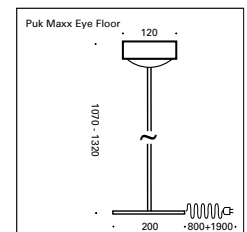
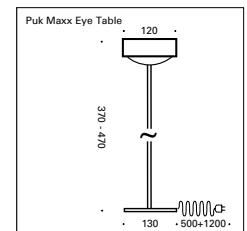

Puk Maxx Eye LED	Puk Maxx Eye Halogen	Höhe height	Puk Maxx Eye LED	Puk Maxx Eye Halogen	Höhe height	Gehäuse body
LED: <b>A*</b> 2 x 12W ~1.800lm ~2.800k	GY6.35/QT-LP12: <b>B</b> 1 x 50W IRC ~1.250lm ~2.800k		LED: <b>A*</b> 2 x 12W ~1.800lm ~2.800k	GY6.35/QT-LP12: <b>B</b> 1 x 50W IRC ~1.250lm ~2.800k		
<b>Table</b>	<b>Table</b>		<b>Table</b>	<b>Table</b>		
6-383701	6-383701-H	370 mm	6-384701	6-384701-H	470 mm	chrome matt
6-383702	6-383702-H	370 mm	6-384702	6-384702-H	470 mm	chrome
6-383703	6-383703-H	370 mm	6-384703	6-384703-H	470 mm	nickel matt
6-383704	6-383704-H	370 mm	6-384704	6-384704-H	470 mm	white/chrome
6-383705	6-383705-H	370 mm	6-384705	6-384705-H	470 mm	black/chrome
6-383707	6-383707-H	370 mm	6-384707	6-384707-H	470 mm	anthracite/chrome
<b>Floor</b>	<b>Floor</b>		<b>Floor</b>	<b>Floor</b>		
6-3810701	6-3810701-H	1.070 mm	6-3813201	6-3813201-H	1.320 mm	chrome matt
6-3810702	6-3810702-H	1.070 mm	6-3813202	6-3813202-H	1.320 mm	chrome
6-3810703	6-3810703-H	1.070 mm	6-3813203	6-3813203-H	1.320 mm	nickel matt
6-3810704	6-3810704-H	1.070 mm	6-3813204	6-3813204-H	1.320 mm	white/chrome
6-3810705	6-3810705-H	1.070 mm	6-3813205	6-3813205-H	1.320 mm	black/chrome
6-3810707	6-3810707-H	1.070 mm	6-3813207	6-3813207-H	1.320 mm	anthracite/chrome

Bei den Puk Maxx Leuchten werden zu dem Leuchtenkopf die Gläser/ Linsen und optional die Farbfilter separat dazubestellt! Artikelnummern entnehmen Sie bitte der Equipment-Tabelle auf Seite 107.

With the Puk Maxx lamps, the glasses, lenses and optional the color filters are ordered separately. Please check the equipment list on page 107 for item numbers.



Puk Maxx Table, chrome



# Puk Maxx Table

Tischleuchte mit einem Leuchtenkopf, Niedervolt Halogen (mit Dimmer) oder LED Power (nur mit Schalter), Kopf drehbar, Arm schwenkbar.

Table lamp with one head, low voltage halogen (with dimmer) or LED power (only with switch), head rotatable, arm pivoting.



Puk Maxx Table, Detail



Puk Maxx Table, chrome

Puk Maxx Table LED	Puk Maxx Table Halogen	Armlänge arm length	Gehäuse body
LED: <b>A+</b> 2 x 12W ~1.800lm ~2.800k	GY6.35/QT-LP12: <b>B</b> 1 x 50W IRC ~1.250lm ~2.800k		
6-38601	6-38601-H	600 mm	chrome matt
6-38602	6-38602-H	600 mm	chrome
6-38603	6-38603-H	600 mm	nickel matt
6-38604	6-38604-H	600 mm	white/chrome
6-38605	6-38605-H	600 mm	black/chrome
6-38607	6-38607-H	600 mm	anthracite/chrome
6-38801	6-38801-H	800 mm	chrome matt
6-38802	6-38802-H	800 mm	chrome
6-38803	6-38803-H	800 mm	nickel matt
6-38804	6-38804-H	800 mm	white/chrome
6-38805	6-38805-H	800 mm	black/chrome
6-38807	6-38807-H	800 mm	anthracite/chrome

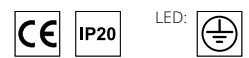
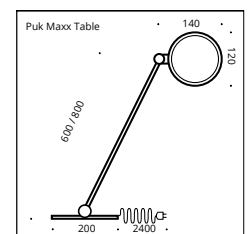

Bei den Puk Maxx Leuchten werden zu dem Leuchtenkopf die Gläser/ Linsen und optional die Farbfilter separat dazubestellt! Artikelnummern entnehmen Sie bitte der Equipment-Tabelle auf Seite 107.

With the Puk Maxx lamps, the glasses, lenses and optional the color filters are ordered separately. Please check the equipment list on page 107 for item numbers.





Puk Maxx Floor Mini, chrome



# Puk Maxx Floor Mini

Stand- und Leseleuchte, Niedervolt Halogen (mit Fußdimmer) oder LED Power (nicht mit Dimmer erhältlich), Kopf drehbar, Arm schwenkbar.

Floor and reading lamp, low voltage halogen (floor dimmer) or LED power (not available with dimmer), head rotatable, arm pivoting.



Puk Maxx Floor Mini, chrome



Schwarzer Kopf und Fuß, black head and base

Puk Maxx Floor Mini LED	Puk Maxx Floor Mini Halogen	Armlänge arm length	Gehäuse body
LED: <b>A+</b> 2 x 12W ~1.800lm ~2.800k	GY6.35/QT-LP12: <b>B</b> 1 x 50W IRC ~1.250lm ~2.800k		
6-381201	6-381201-H	1.250 mm	chrome matt
6-381202	6-381202-H	1.250 mm	chrome
6-381203	6-381203-H	1.250 mm	nickel matt
6-381204	6-381204-H	1.250 mm	white/chrome
6-381205	6-381205-H	1.250 mm	black/chrome
6-381207	6-381207-H	1.250 mm	anthracite/chrome

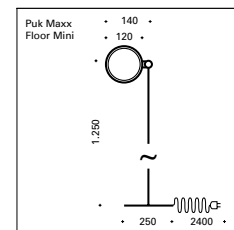

Bei den Puk Maxx Leuchten werden zu dem Leuchtenkopf die Gläser/ Linsen und optional die Farbfilter separat dazubestellt! Artikelnummern entnehmen Sie bitte der Equipment-Tabelle auf Seite 107.

With the Puk Maxx lamps, the glasses, lenses and optional the color filters are ordered separately. Please check the equipment list on page 107 for item numbers.





# Puk Maxx Floor Sister

Stand- und Leseleuchte, Niedervolt Halogen (mit Fußdimmer) oder LED Power (nicht mit Dimmer erhältlich), Köpfe drehbar, Arme schwenkbar.

Floor and reading lamp, low voltage halogen (floor dimmer) or LED power (not available with dimmer), heads rotatable, arms pivoting.



Puk Maxx Floor Sister, chrome



Weißer Kopf, white head



Weißer Fuß, white base

Puk Maxx Floor Sister LED	Puk Maxx Floor Sister Halogen	Armlänge arm length	Gehäuse body
LED: <b>A+</b> 4 x 12W ~3.600lm ~2.800k	GY6.35/QT-LP12: <b>B</b> 2 x 50W IRC ~2.500lm ~2.800k		
6-3821201	6-3821201-H	2 x 1.250 mm	chrome matt
6-3821202	6-3821202-H	2 x 1.250 mm	chrome
6-3821203	6-3821203-H	2 x 1.250 mm	nickel matt
6-3821204	6-3821204-H	2 x 1.250 mm	white/chrome
6-3821205	6-3821205-H	2 x 1.250 mm	black/chrome
6-3821207	6-3821207-H	2 x 1.250 mm	anthracite/chrome

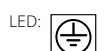
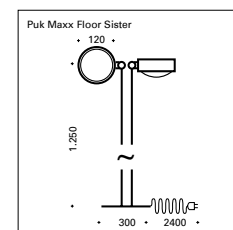

Bei den Puk Maxx Leuchten werden zu dem Leuchtenkopf die Gläser/ Linsen und optional die Farbfilter separat dazubestellt! Artikelnummern entnehmen Sie bitte der Equipment-Tabelle auf Seite 107.

With the Puk Maxx lamps, the glasses, lenses and optional the color filters are ordered separately. Please check the equipment list on page 107 for item numbers.







# Puk Maxx Floor Maxi

Stand- und Leseleuchte, Niedervolt Halogen (mit Fußdimmer) oder LED Power (nicht mit Dimmer erhältlich), Kopf drehbar, Arm schwenkbar.

Floor and reading lamp, low voltage halogen (floor dimmer) or LED power (not available with dimmer), head rotatable, arm pivoting.



Schwarzer Kopf und Fuß, black head and base

Puk Maxx Floor Maxi Single LED	Puk Maxx Floor Maxi Single Halogen	Puk Maxx Floor Maxi Twin LED	Puk Maxx Floor Maxi Twin Halogen	Armlänge arm length	Gehäuse body
LED: <b>A+</b> 2 x 12W ~1.800lm ~2.800k	GY6.35/QT-LP12: <b>B</b> 1 x 50W IRC ~1.250lm ~2.800k	LED: <b>A+</b> 4 x 12W ~3.600lm ~2.800k	GY6.35/QT-LP12: <b>B</b> 2 x 50W IRC ~2.500lm ~2.800k		
6-381801	6-381801-H	6-3818021	6-3818021-H	1.800 mm	chrome matt
6-381802	6-381802-H	6-3818022	6-3818022-H	1.800 mm	chrome
6-381803	6-381803-H	6-3818023	6-3818023-H	1.800 mm	nickel matt
6-381804	6-381804-H	6-3818024	6-3818024-H	1.800 mm	white/chrome
6-381805	6-381805-H	6-3818025	6-3818025-H	1.800 mm	black/chrome
6-381807	6-381807-H	6-3818027	6-3818027-H	1.800 mm	anthracite/chrome

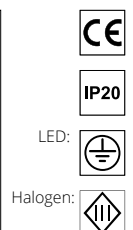
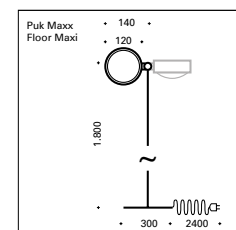

Bei den Puk Maxx Leuchten werden zu dem Leuchtenkopf die Gläser/Linsen und optional die Farbfilter separat dazubestellt! Artikelnummern entnehmen Sie bitte der Equipment-Tabelle auf Seite 107.

With the Puk Maxx lamps, the glasses, lenses and optional the color filters are ordered separately. Please check the equipment list on page 107 for item numbers.



Puk Maxx Floor Mother-Kid chrome





# Puk Maxx Floor Mother-Kid

Stand- und Leseleuchte, Niedervolt Halogen (mit 2 Fußdimmern) oder LED Power (nicht mit Dimmer erhältlich), Köpfe drehbar, Arme schwenkbar.

Floor and reading lamp, low voltage halogen (2 floor dimmer) or LED power (not available with dimmer), heads rotatable, arms pivoting.



Weißer Kopf, white head



Weißer Fuß, white base



Puk Maxx Floor Mother-Kid chrome

Puk Maxx Floor Mother-Kid LED

LED: **A+**  
6 x 12W  
~5.400lm ~2.800k

6-3821801201  
6-3821801202  
6-3821801203  
6-3821801204  
6-3821801205  
6-3821801207

Puk Maxx Floor Mother-Kid Halogen

GY6.35/QT-LP12: **B**  
3 x 50W IRC  
~3.250lm ~2.800k

6-3821801201-H  
6-3821801202-H  
6-3821801203-H  
6-3821801204-H  
6-3821801205-H  
6-3821801207-H

Armlängen  
arm lengths

1.800 mm + 1.250 mm  
1.800 mm + 1.250 mm  
1.800 mm + 1.250 mm  
1.800 mm + 1.250 mm  
1.800 mm + 1.250 mm  
1.800 mm + 1.250 mm

Gehäuse  
body

chrome matt  
chrome  
nickel matt  
white/chrome  
black/chrome  
anthracite/chrome

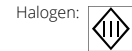
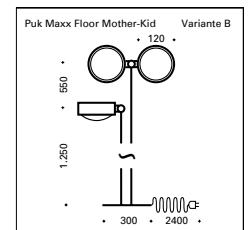
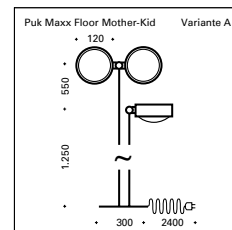

Bei den Puk Maxx Leuchten werden zu dem Leuchtenkopf die Gläser/ Linsen und optional die Farbfilter separat dazubestellt! Artikelnummern entnehmen Sie bitte der Equipment-Tabelle auf Seite 107.

With the Puk Maxx lamps, the glasses, lenses and optional the color filters are ordered separately. Please check the equipment list on page 107 for item numbers.





Puk Maxx Wall color filter blue



# Puk Maxx Equipment

Linsen, Gläser und Farbfilter frei zu kombinieren.  
Lenses, glasses and color filter for separate order.

Art. Nr. item no.	Einsatz insert	Beschreibung description
2-3035	Alurefektor, aluminium baffle	Lichtstopp, empfohlen unter Glas lightstop, recommended under glass
5-38602	Alurefektor Disc aluminium baffle Disc	Lichtstopp für Tri Star S. 91 lightstop for Tri Star p. 91
2-3036	Linse, lens	klar, clear
2-3036-s	Linse, lens	einseitig mattiert, frosted on one side
2-3037	Glas, glass	beidseitig mattiert, passt nicht unter Linse frosted on both sides, doesn't fit under lens
2-3038	Farbfilter	rot, red
2-3039	empfohlen ohne Glas	magenta, magenta
2-3040	color filter	gelb, yellow
2-3043	recommended	blau, blue
2-3044	without glass	grün, green

Für 8 Watt LED statt 12 Watt LED bitte **-8** hinter die Artikelnummer hängen, dimmbar  
For a 8 Watt LED instead of 12 Watt LED attach **-8** behind the item number, dimmable

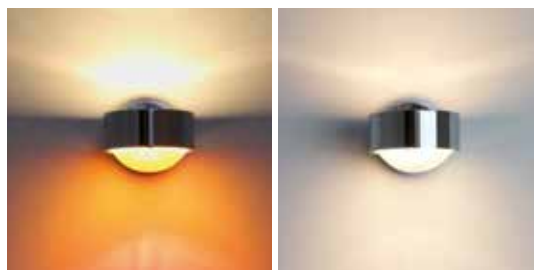
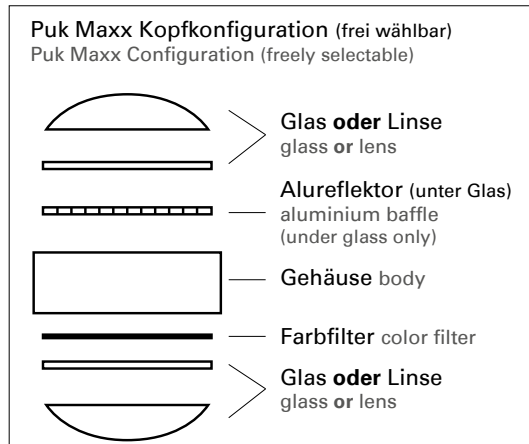

mattierte Linse mit und ohne Farbfilter  
frosted lens with and without color filter

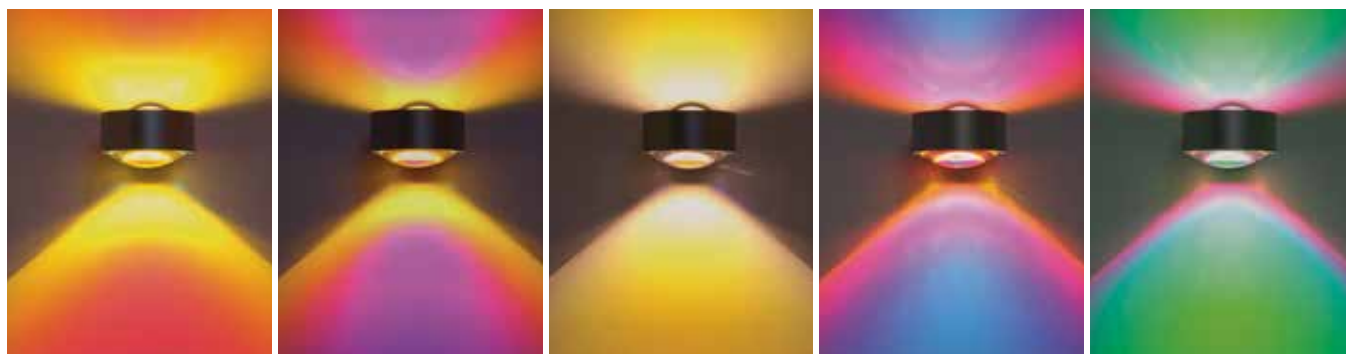

Farbfilter rot  
color filter red

Farbfilter magenta  
color filter magenta

Farbfilter gelb  
color filter yellow

Farbfilter blau  
color filter blue

Farbfilter grün  
color filter green

## 1-3 Phasen Adapter - Check In

Für das Eutrac Schienensystem. Für 1. Puk Maxx Turn (S. 73) , 2. Puk Maxx Side (S. 74-77),  
3. Puk Maxx Long One & 4. Long Double (S. 83)! Kürzel hinter die Artikelnummer der Lampe  
anhängen.

For Eutrac metal rail system. For 1. Puk Maxx Turn (p. 73) , 2. Puk Maxx Side (p. 74-77), 3. Puk  
Maxx Long One & 4. Long Double (p. 83)! Please attach behind item number of the lamp.

Art. Nr. item no.	Ausführung design
ci1-w	1 Phasen Adapter in weiß, 1 Phase adapter in white
ci1-s	1 Phasen Adapter in silber, 1 Phase adapter in silver
ci3-w	3 Phasen Adapter in weiß, 3 Phase adapter in white
ci3-s	3 Phasen Adapter in silber, 3 Phase adapter in silver

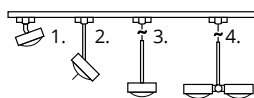



Puk Meg Maxx Wall chrome



# Puk Meg Maxx Wall »+« & Plus

Wandleuchte, Hochvolt LED Power, CDMT oder Hochvolt Halogen, Kopf **drehbar** mit Verstellstift, dimmbar.  
 Wall lamp, high LED power, CDMT or high voltage halogen, head **rotatable** with adjusting pin, dimmable.



Puk Meg Maxx Wall nickel matt



Puk Meg Maxx Plus chrome



Puk Meg Maxx Wall nickel matt

Puk Meg Maxx Wall »+« LED	Puk Meg Maxx Wall »+« CDMT*	Puk Meg Maxx Wall »+« Halogen	ø x Wandabstand in mm ø x wall space in mm	Gehäuse body
LED: <b>A+</b> 2 x 18W, ~3.000lm ~2.800k	CDMT: <b>A+</b> 35W, ~3.300lm ~2.800k	G9/QT14: <b>D</b> 3 x 33W, ~1.380lm ~2.800k		
2-40801	2-40801-CDMT	2-40801-H	160 x 185	chrome matt
2-40802	2-40802-CDMT	2-40802-H	160 x 185	chrome
2-40803	2-40803-CDMT	2-40803-H	160 x 185	nickel matt
2-40804	2-40804-CDMT	2-40804-H	160 x 185	white/chrome
2-40805	2-40805-CDMT	2-40805-H	160 x 185	black/chrome
2-40807	2-40807-CDMT	2-40807-H	160 x 185	anthracite/chrome
Puk Meg Maxx Plus LED	Puk Meg Maxx Plus CDMT*	Puk Meg Maxx Plus Halogen	ø x Höhe in mm ø x high in mm	Gehäuse body
LED: <b>A+</b> 1 x 18W, ~1.500lm ~2.800k	CDMT: <b>A+</b> 35W, ~3.300lm ~2.800k	G9/QT14: <b>D</b> 3 x 33W, ~1.380lm ~2.800k		
2-402801	2-402801-CDMT	2-402801-H	160 x 80	chrome matt
2-402802	2-402802-CDMT	2-402802-H	160 x 80	chrome
2-402803	2-402803-CDMT	2-402803-H	160 x 80	nickel matt
2-402804	2-402804-CDMT	2-402804-H	160 x 80	white
2-402805	2-402805-CDMT	2-402805-H	160 x 80	black
2-402807	2-402807-CDMT	2-402807-H	160 x 80	anthracite

\*Ohne CDMT-Leuchtmittel, Vorschaltgerät extern. Without CDMT lamp, ballast not integrated.

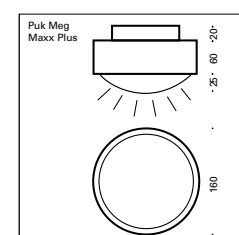
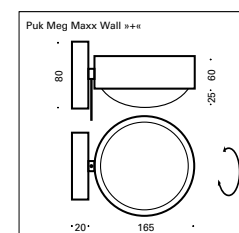

Bei den Puk Maxx Leuchten werden zu dem Leuchtenkopf die Gläser/ Linsen und optional die Farbfilter separat dazubestellt! Artikelnummern entnehmen Sie bitte der Equipment-Tabelle auf Seite 111.

With the Puk Maxx lamps, the glasses, lenses and optional the color filters are ordered separately. Please check the equipment list on page 111 for item numbers.







# Puk Meg Maxx Equipment

Linsen, Gläser und Farbfilter frei zu kombinieren.  
Lenses, glasses and color filter for separate order.

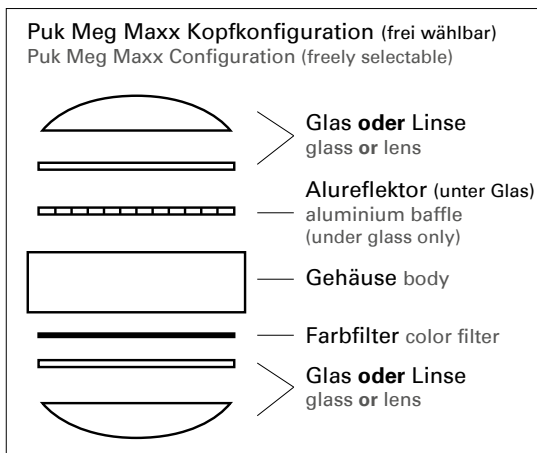

Farbfilter rot  
color filter red



Farbfilter magenta  
color filter magenta



Farbfilter gelb  
color filter yellow



Farbfilter blau  
color filter blue



Farbfilter grün  
color filter green

Art. Nr. item no.	Einsatz insert	Beschreibung description
2-5035	Alurefektor, aluminium baffle	Lichtstopp, empfohlen unter Glas lightstop, recommended under glass
2-5036	Linse, lens	klar, clear
2-5036-s	Linse, lens	einseitig mattiert, frosted on one side
2-5037	Glas, glass	beidseitig mattiert, passt nicht unter Linse frosted on both sides, doesn't fit under lens
2-5038	Farbfilter	rot, red
2-5039	empfohlen ohne Glas	magenta, magenta
2-5040	color filter	gelb, yellow
2-5043	recommended	blau, blue
2-5044	without glass	grün, green



mattierte Linse mit und ohne Farbfilter  
frosted lens with and without color filter

Für 12 Watt LED statt 18 Watt LED bitte **-12** hinter die Artikelnummer hängen, dimmbar  
For a 12 Watt LED instead of 18 Watt LED attach **-12** behind the item number, dimmable







# Puk, Puk Maxx & Puk Meg Maxx Outdoor



Puk Meg Maxx Wall ø 160 mm, Puk Maxx Wall ø 120 mm & Puk Wall ø 80 mm



Farbfilter Halogen Color Filter Halogen







# Puk Outdoor

Wand- und Deckenleuchten für den Außenbereich, LED-Technologie.  
Wall and Ceiling lamp for outdoor area, LED-Technology.



Puk Wall Outdoor, chrome matt



Puk Turn Outdoor, chrome



Puk Plus Outdoor, chrome

Puk Outdoor LED: <b>A+</b> ~2.800k	ø x H ø x h	Gehäuse body
<b>Wall 2 x 8W ~1.200lm</b>		
2-48011	100 x 65 mm	chrome matt
2-48012	100 x 65 mm	chrome
2-48014	100 x 65 mm	white
2-48015	100 x 65 mm	black
2-48017	100 x 65 mm	anthracite
<b>Plus 1 x 8W ~600lm</b>		
2-48111	80 x 70 mm	chrome matt
2-48112	80 x 70 mm	chrome
2-48114	80 x 70 mm	white
2-48115	80 x 70 mm	black
2-48117	80 x 70 mm	anthracite
<b>Turn downlight 1 x 8W ~600lm</b>		
2-48211	80 x 120 mm	chrome matt
2-48212	80 x 120 mm	chrome
2-48214	80 x 120 mm	white/chrome
2-48215	80 x 120 mm	black/chrome
2-48217	80 x 120 mm	anthracite/chrome

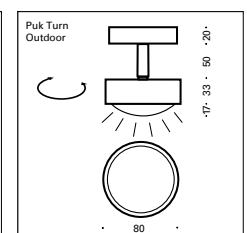
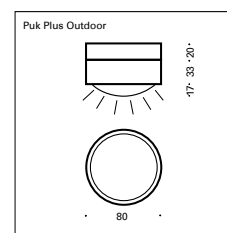
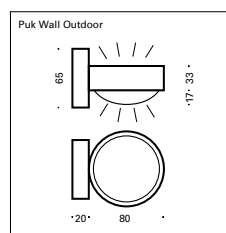

Bei den Puk Leuchten werden zu dem Leuchtenkopf die Gläser/Linsen und optional die Farbfilter separat dazubestellt! Artikelnummern entnehmen Sie bitte der Equipment-Tabelle auf Seite 117.

With the Puk lamps, the glasses, lenses and optional the color filters are ordered separately. Please check the equipment list on page 117 for item numbers.







# Puk Outdoor Equipment

Linsen, Gläser und Farbfilter frei zu kombinieren.  
Lenses, glasses and color filter for separate order.

Art. Nr. item no.	Einsatz insert	Beschreibung description
2-2025	Alurefektor, aluminium baffle	Lichtstopp, empfohlen unter Glas lightstop, recommended under glass
2-2026	Linse, lens	klar, clear
2-2026-s	Linse, lens	einseitig mattiert, frosted on one side
2-2027	Glas, glass	beidseitig mattiert, passt nicht unter Linse frosted on both sides, doesn't fit under lens
2-2028	Farbfilter nur unter	rot, red
2-2029	Glas oder Linse	magenta, magenta
2-2030	color filter	gelb, yellow
2-2033	only under glass	blau, blue
2-2034	or lens	grün, green



rot red



magenta magenta



gelb yellow



blau blue



grün green

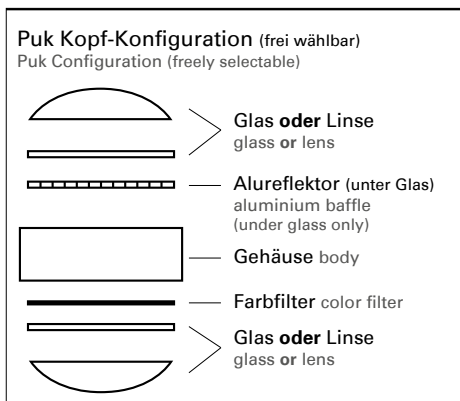

mattierte Linse mit und ohne Farbfilter  
frosted lens with and without color filter





Fuk Maxx Wall Outdoor, chrome matt



# Puk Maxx Outdoor

Wand- und Deckenleuchten für den Außenbereich, LED-Technologie.  
Wall and Ceiling lamp for outdoor area, LED-Technology.



Puk Maxx Plus Outdoor, chrome matt



Puk Maxx Turn Outdoor, nur drehbar only pivotable



Puk Maxx Wall Outdoor, drehbar pivotable

Puk Maxx Outdoor LED: <b>A+</b> ~2.800k	ø x H ø x h	Gehäuse body
<b>Wall</b> 2 x 8W ~1.200lm		
2-40811	140 x 80 mm	chrome matt
2-40812	140 x 80 mm	chrome
2-40814	140 x 80 mm	white
2-40815	140 x 80 mm	black
2-40817	140 x 80 mm	anthracite
<b>Plus</b> 1 x 12W ~900lm		
2-4018001	120 x 96 mm	chrome matt
2-4018002	120 x 96 mm	chrome
2-4018004	120 x 96 mm	white
2-4018005	120 x 96 mm	black
2-4018007	120 x 96 mm	anthracite
<b>Turn</b> downlight 1 x 12W ~900lm		
2-4028001	120 x 146 mm	chrome matt
2-4028002	120 x 146 mm	chrome
2-4028004	120 x 146 mm	white/chrome
2-4028005	120 x 146 mm	black/chrome
2-4028007	120 x 146 mm	anthracite/chrome
<b>Turn</b> up- & downlight 2 x 8W ~1.200lm		
2-4038001	120 x 146 mm	chrome matt
2-4038002	120 x 146 mm	chrome
2-4038004	120 x 146 mm	white/chrome
2-4038005	120 x 146 mm	black/chrome
2-4038007	120 x 146 mm	anthracite/chrome

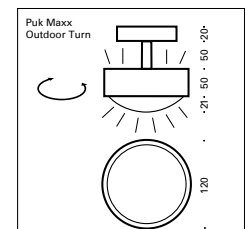
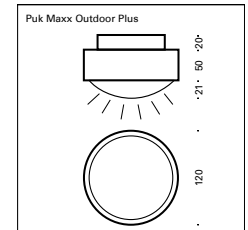
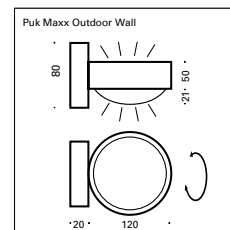

Bei den Puk Maxx Leuchten werden zu dem Leuchtenkopf die Gläser/ Linsen und optional die Farbfilter separat dazubestellt! Artikelnummern entnehmen Sie bitte der Equipment-Tabelle auf Seite 121.

With the Puk Maxx lamps, the glasses, lenses and optional the color filters are ordered separately. Please check the equipment list on page 121 for item numbers.



Puk Maxx Wall Outdoor chrome





# Puk Maxx Outdoor Equipment

Linsen, Gläser und Farbfilter frei zu kombinieren.  
Lenses, glasses and color filter for separate order.

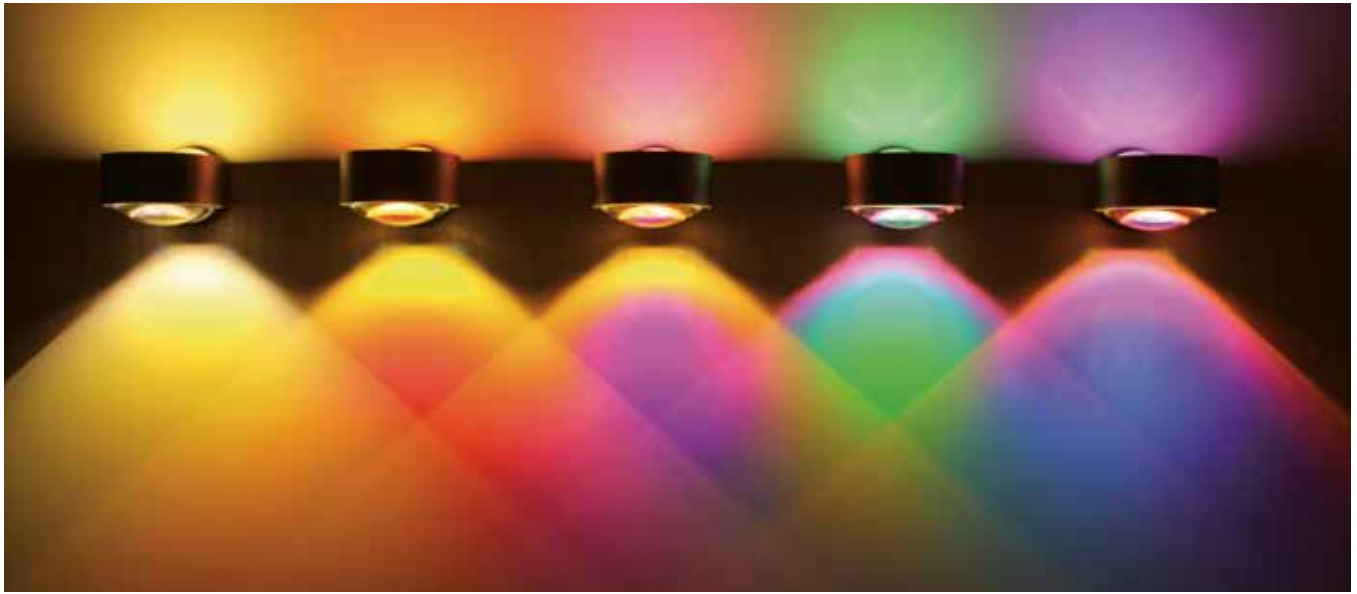

gelb yellow

rot red

magenta magenta

grün green

blau blue

Art. Nr. item no.	Einsatz insert	Beschreibung description
2-3036	Linse, lens	klar, clear
2-3036-s	Linse, lens	einseitig mattiert, frosted on one side
2-3037	Glas, glass	beidseitig mattiert, passt nicht unter Linse frosted on both sides, doesn't fit under lens
2-4038	Farbfilter nur unter	rot, red
2-4039	Glas oder Linse	magenta, magenta
2-4040	colour filter	gelb, yellow
2-4043	only under glass	blau, blue
2-4044	or lens	grün, green

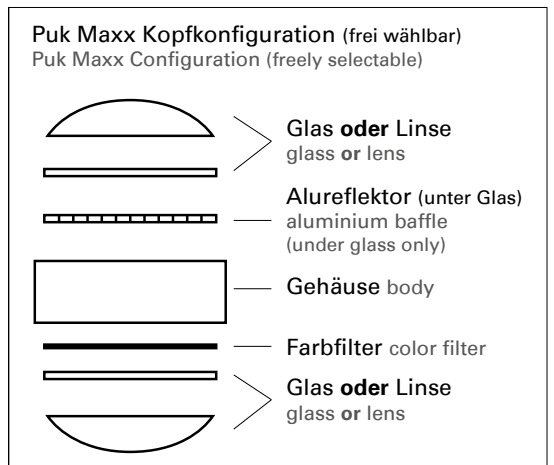







# Puk Meg Maxx Outdoor

Wand- und Deckenleuchten für den Außenbereich, LED-Technologie.  
Wall and Ceiling lamp for outdoor area, LED-Technology.

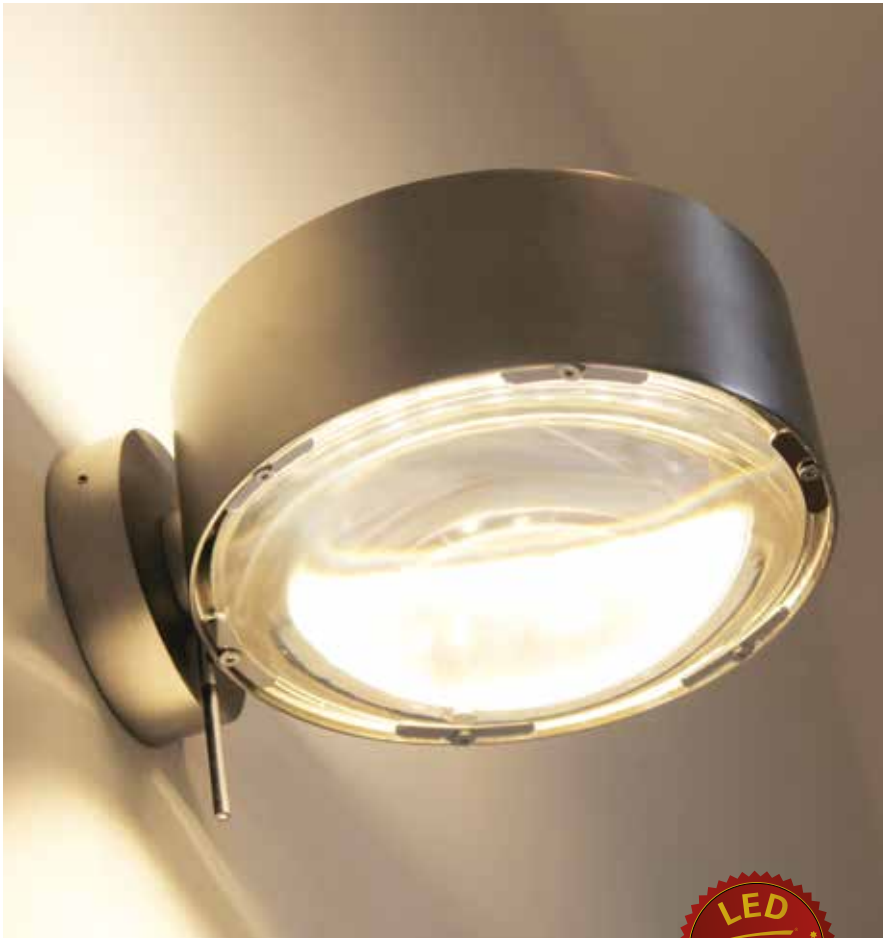

Puk Meg Maxx Wall Outdoor chrome matt



Puk Meg Maxx Plus Outdoor chrome



Puk Meg Maxx Outdoor Detail



Puk Meg Maxx Wall »+« LED LED: <b>A+</b> 2 x 18W, ~3.000lm ~2.800k	ø x Wandabstand in mm ø x wall space in mm	Puk Meg Maxx Plus LED LED: <b>A+</b> 1 x 18W, ~1.500lm ~2.800k	ø x Höhe in mm ø x height in mm	Gehäuse body
2-50811	160 x 185	2-50801	160 x 80	chrome matt
2-50812	160 x 185	2-50802	160 x 80	chrome
2-50814	160 x 185	2-50804	160 x 80	white/chrome
2-50815	160 x 185	2-50805	160 x 80	black/chrome
2-50817	160 x 185	2-50807	160 x 80	anthracite/chrome

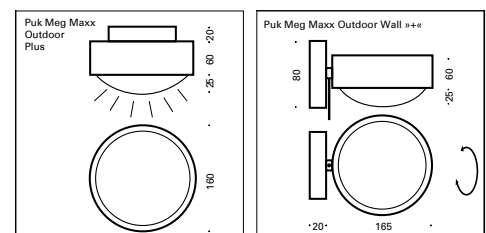

Bei den Puk Leuchten werden zu dem Leuchtenkopf die Gläser/Linsen und optional die Farbfilter separat dazubestellt! Artikelnummern entnehmen Sie bitte der Equipment-Tabelle auf Seite 125.

With the Puk lamps, the glasses, lenses and optional the color filters are ordered separately. Please check the equipment list on page 125 for item numbers.







# Puk Meg Maxx Outdoor Equipment

Linsen, Gläser und Farbfilter frei zu kombinieren.  
Lenses, glasses and color filter for separate order.

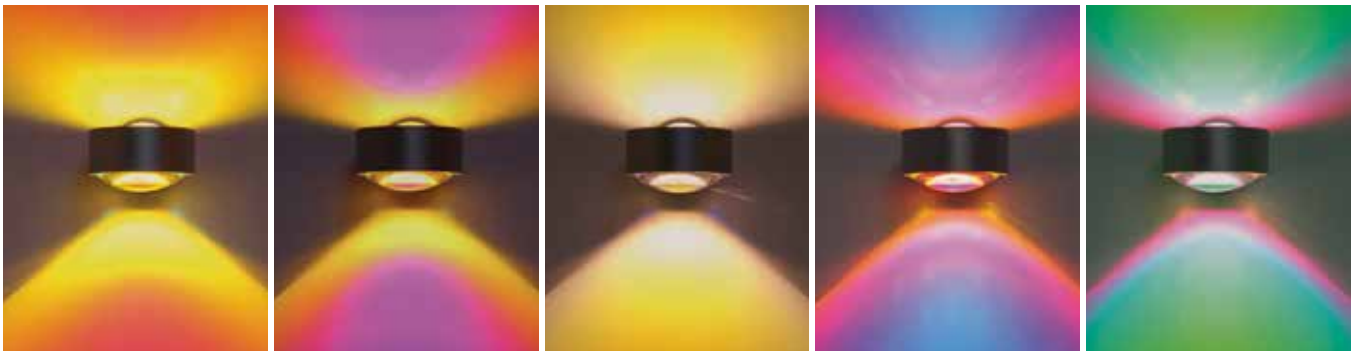

Farbfilter rot  
color filter red

Farbfilter magenta  
color filter magenta

Farbfilter gelb  
color filter yellow

Farbfilter blau  
color filter blue

Farbfilter grün  
color filter green

Art. Nr. item no.	Einsatz insert	Beschreibung description
2-5035	Alurefektor, aluminium baffle	Lichtstopp, empfohlen unter Glas lightstop, recommended under glass
2-5036	Linse, lens	klar, clear
2-5036-s	Linse, lens	einseitig mattiert, frosted on one side
2-5037	Glas, glass	beidseitig mattiert, passt nicht unter Linse frosted on both sides, doesn't fit under lens
2-5038	Farbfilter	rot, red
2-5039	empfohlen ohne Glas	magenta, magenta
2-5040	color filter	gelb, yellow
2-5043	recommended	blau, blue
2-5044	without glass	grün, green

Puk Meg Maxx Kopfkfiguration (frei wählbar)  
Puk Meg Maxx Configuration (freely selectable)

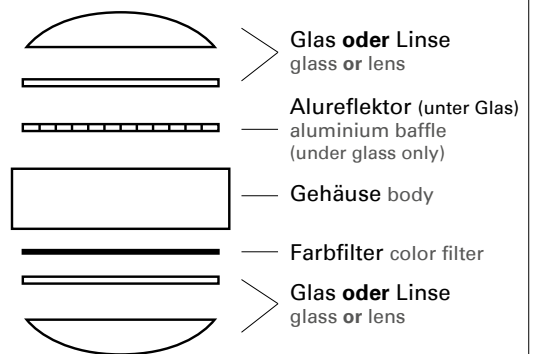





Puk Fix chrome



Puk Ceiling Sister chrome



Puk One



Puk Wing Twin nickel matt



Puk Maxx Long Double chrome

Design by *Paul Biel*



Puk Maxx Wall Outdoor chrome



Puk Turn chrome



Puk Wall



Puk Eye Table chrome



Puk Maxx Wall chrome



Light

Wellness

Design by *Paul Biel*





# Lichtspiegel Illuminated mirrors







# Leuchtspiegel

## Illuminated Mirrors

Anfertigung auf jedes Maß.  
Manufacturing to any dimension.  
»Made in Germany«

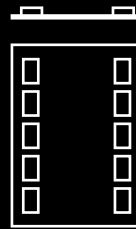

Visagist 138 – 141

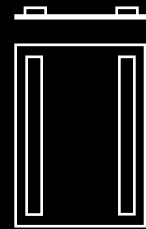

FineLine 142 – 145

Modelle und Formen 132 – 133  
Models and shapes

Spiegel Infos 134 – 137  
Mirror Information

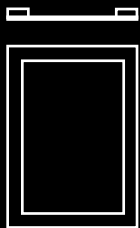

SideLight 146 – 149

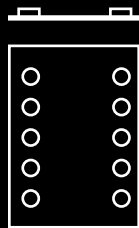

DotLight 150 – 153

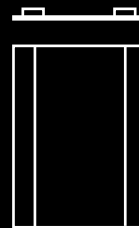

BrightLight 154 – 157

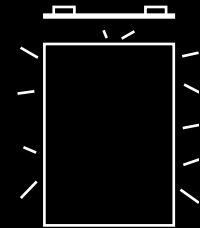

InLight 158 – 161



BulbLine 162 – 165

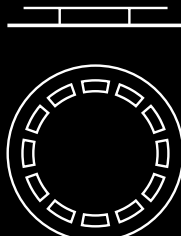



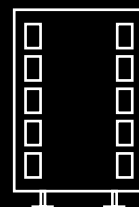



Circle 167

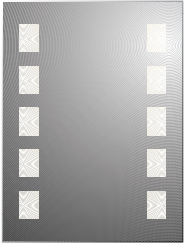

Vision 169

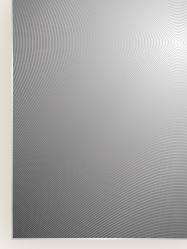
Doppelwaschtisch 170  
Double wash basin  
Ornaments 171

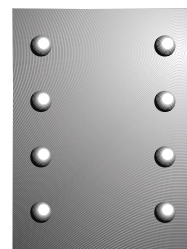
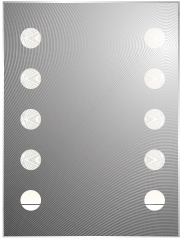
# Lichtspiegel Modellübersicht Survey of models

Bild picture	Name name	Design design	Bild picture	Name name	Design design
	<b>Visagist</b> A 1 2 3 5 6 7 8 9 10 11 12 13 14 15 16 17 s. Seite 139 s. page 139	Blockmuster inkl. Prismenabdeckung, seitlich abnehmbar  Block pattern design incl. prism cover removable on the side		<b>BrightLight</b> A 1 2 3 5 6 7 8 9 10 11 12 15 16 s. Seite 155 s. page 155	Linienmuster, rechts und links außen satinert  Lined pattern design stained outwards on the left and right side
	<b>FineLine</b> A 1 2 3 5 6 7 8 9 10 11 12 13 14 15 16 s. Seite 143 s. page 143	Linienmuster inkl. Prismenabdeckung, seitlich abnehmbar  Lined pattern design incl. prism cover removable on the side		<b>InLight</b> A 1 2 3 5 6 7 8 9 10 11 15 16 s. Seite 159 s. page 159	indirekter, seitol. Lichtaustritt mit LED, Leuchtstofflampen T5 od. Niedervolt G4 Halogen  indirect, lateral light out- let with LED, flourescent lamps T5 or low voltage H4 halogen
	<b>SideLight</b> A 1 2 3 5 6 7 8 9 10 11 12 15 16 s. Seite 147 s. page 147	umlaufende Linie, rundum satinert  framing line, stained all around		<b>BulbLine</b> A 1 4 7 8 9 10 12 14 15 16 s. Seite 163 s. page 163	Lichtkugeln opal, incl. seitl. Aluabdeckung  Light bulbs opal, including lateral aluminium cover
	<b>DotLight</b> A 1 2 3 5 6 7 8 9 10 11 12 13 14 15 16 17 s. Seite 151 s. page 151	Punktmuster inkl. Prismenabdeckung, seitlich abnehmbar  Dotted pattern design incl. prism cover removable on the side			seitl. Aluabdeckung lateral aluminium cover  Prismenabdeckung prism cover

## Circle

runder Spiegel mit  
umlaufendem Muster  
round mirror with framing pattern



VisaCircle: 17

VisaCircle



DotCircle



SideCircle



FineCircle







## Lichtspiegel Formen Illuminated mirror shapes

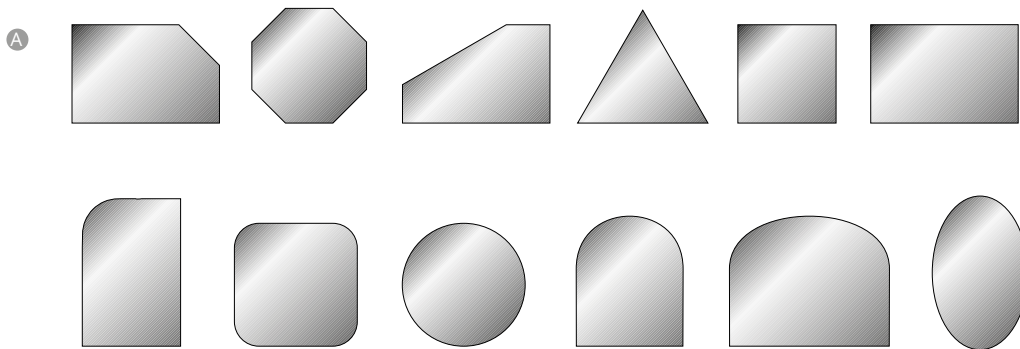

## Lichtspiegel Technik Illuminated mirror technology

- 1 IP 44 (spritzwassergeschützt), IP 44 splash proof
- 2 IP 21, IP 21
- 3 Halogen Niedervolt, Low voltage halogen
- 4 Halogen Hochvolt, High voltage halogen
- 5 Leuchtstofflampen T5, Fluorescent lamps T5
- 6 LED (lange Lebensdauer & energiesparend), LED (long life & energy saving)

## Lichtspiegel Extras Illuminated mirror extras

- 7 Facette 20 mm, Facet 20 mm
- 8 Einbausteckdose, Flush mounting socket
- 9 Einbauschalter, Flush mounting switch
- 10 Schalter mittig verdeckt, Switch with central cover
- 11 Dimmer mit Taster und Memory, Dimmer with pushbutton and memory
- 12 Drehdimmer für Leuchtstoff T5, Rotating dimmer for fluorescent lamp T5
- 13 Aluabblendeleiste, Aluminium cover strip
- 14 Klappspiegel, Fold-away mirror
- 15 Raumteilerausbildung, Partition construction
- 16 Spiegelheizung, Mirror heater
- 17 Farbfilter, Color filter



# Typisch Top Light

## Quintessentially Top Light

### Technologie

Schattenfreie Ausleuchtung des Betrachters. Kinn-, Hals- und Nasenbereich erhalten ihre optimale Ausleuchtung.

### Technology

Shadow-free illumination of the viewer. Chin-, neck- and nose-area are illuminated ideally.

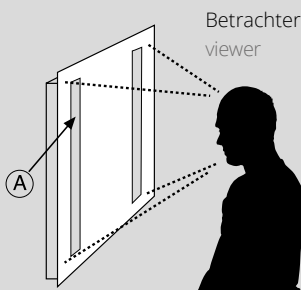

### Das Licht

Blendfreie Beleuchtung durch hightech Diffusoren und Reflektoren in: Halogen, Xenon, Leuchtstoff, LED high Power.

### The Light

Anti-glare illumination through high tech diffusors and baffles in: halogen, Xenon, fluorescent lamps, LED high power.

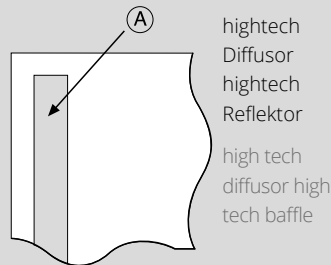

### Der Spiegel

Fertigung nach deutscher Spiegelnorm. 12 Schichtverfahren, Kristall Float Glas und eine Reflektionsschicht aus reinem Silber sorgen für eine dauerhafte Tonwiedergabe.

### The Mirror

Manufacturing according to German mirror standard. 12 layer proceedings, crystal float glass and a reflective layer made of pure silver provide a durable reproduction.

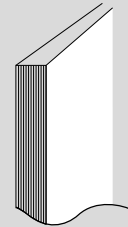

## Das Original! The Original!

Die Spiegelkollektion der besonderen Klasse.

Der Lichtspiegel von Top Light erfüllt Ihren Wunsch nach:

- ▶ schattenfreier Ausleuchtung
- ▶ tageslichtähnlicher Farbwiedergabe
- ▶ Blendfreiheit

Ganzheitliches Wohlfühlambiente ist unsere Philosophie - dabei so individuell, dass jeder seinen Stil finden kann.

Top Light hat für Sie nicht nur eine spitzen Lichttechnik entwickelt, sondern verarbeitet nur Spiegel nach deutscher Spiegelnorm. Jeden Tag neue Akzente!

Wonach steht Ihnen heute der Sinn?

The exceptional class: Our mirror collection.

The illuminated mirror by Top Light fulfills you desire for:

- ▶ shadow-free illumination
- ▶ daylight analogue color reproduction
- ▶ anti-glare

Wholistic well-being is our philosophy - this includes the individuality to let you find your own style. Top Light has developed high grade lighting technology and as well only produces mirrors according to the German mirror standard. New accents every day!





# Lichtspiegel

## Illuminated mirrors

Eine außergewöhnliche und umfangreiche Spiegelkollektion der besonderen Art die keinen Wunsch mehr offen lässt. Die Kristallspiegel sind satiniert, die Kanten geschliffen und poliert. Die Fertigung erfolgt nach deutscher Spiegelnorm.

A very exceptional and extensive collection of mirrors that makes all your wishes come true. The crystal mirrors are glazed, the edges are smoothed and polished. We manufacture according to German mirror standards.

- ▶ Anfertigung nach Maß
  - ▶ LED (lange Lebensdauer & energiesparend)
  - ▶ Halogen Niedervolt
  - ▶ Halogen Hochvolt
  - ▶ IP 44 spritzwassergeschützt
  - ▶ T5 Leuchtstoff
  - ▶ Softstart
  - ▶ nur 25 mm Wandabstand
  - ▶ 6 mm Kristallspiegel (deutsche Spiegelnorm)
- 
- ▶ Manufactured to any dimension
  - ▶ LED (long life & energy saving)
  - ▶ Low voltage halogen
  - ▶ High voltage halogen
  - ▶ Ip 44 Splash proof
  - ▶ T5 fluorescent lamps
  - ▶ soft start
  - ▶ only 25 mm Wall spacing
  - ▶ 6 mm crystal mirror (german mirror standards)



Doppelwaschtisch



SideLight



BulbLine







# LED New Line

Erleben Sie modernste LED-Technik mit unseren blendfreien Lichtspiegeln. Die neue Reflektortechnik sorgt für durchgängiges und gleichmäßig helles Licht an allen matteden Stellen. Natürlich fertigen wir auch in Niedervolt Halogen und T5 Technologie bei einer Schutzart von IP20 oder IP44.

Experience the latest LED technology with our anti-glare illuminated mirrors. The new reflector technology ensures consistent and uniformly bright light on all matted areas. Of course we also manufacture in low voltage halogen and T5 technology with a protection value of IP20 or IP44.

## Die Spiegelkollektion der besonderen Klasse.

Der Lichtspiegel von Top Light erfüllt Ihren Wunsch nach:

- ▶ schattenfreier und homogener Ausleuchtung (keine Lichtpunkte)
- ▶ tageslichtähnlicher Farbwiedergabe
- ▶ Blendfreiheit
- ▶ Standardgrößen und Fertigung nach Maß
- ▶ 1.500 lm Lichtleistung pro Meter Satinierung, 2.800 Kelvin Lichttemperatur\*
- ▶ Gemäß EU-Verordnung 874/2012 für Leuchtmittel der Energieklasse A+

\*je nach Ausführung / gemessen ohne Satinierung

## The exceptional class: Our mirror collection.

The illuminated mirror by Top Light fulfills you desire for:

- ▶ shadow free and homogeneous illumination (no light points)
- ▶ daylight-like color reproduction
- ▶ anti-glare
- ▶ standard sizes and made to measure production
- ▶ 1.500 lm light output per meter of satin, 2.800 Kelvin light temperature\*
- ▶ In accordance with EU Regulation 874/2012 for lamps in energy class A+

\*depending on version / measured without frosting



FineLine



FineLine – InLight



BrightLight





# Visagist

Die Kristallspiegel sind satiniert, die Kanten geschliffen und poliert, mit Blockmuster, inkl. Leuchtmittel, LED, T5 oder G4 klar, gefertigt nach deutscher Spiegelnorm.

The crystal mirrors are glazed, the edges are smoothed and polished, with block pattern design, incl. LED, T5 or clear G4 lamps. Manufactured according to German mirror standards.



Visagist

### Sondergrößen:

Wir fertigen nach Maß, in LED-Power, Halogentechnik oder T5-Neontechnik (Satinierung richtet sich nach Leuchtmittellänge) in IP 20 oder IP 44.

### Special sizes:

We manufacture to any size with LED-Power, halogen technology or T5 neon technology (satin finish depends on lamp length) in IP 20 or IP 44.

## Standardgrößen (H x B) Standard sizes (h x w)

H 60 x B 45 cm

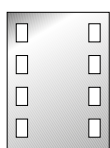

a. 1-016045-LED  
c. 1-016045 8 LS

H 80 x B 40 cm

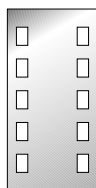

a. 1-018040-LED  
c. 1-018040 10 LS

H 70 x B 50 cm

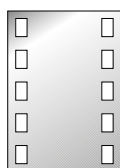

a. 1-017050-LED  
c. 1-017050 10 LS

H 70 x B 70 cm

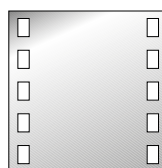

a. 1-017070-LED  
c. 1-017070 10 LS

H 80 x B 60 cm

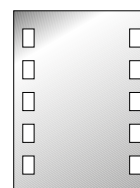

a. 1-018060-LED  
c. 1-018060 10 LS

H 60 x B 80 cm

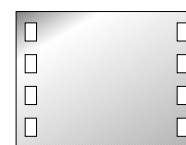

a. 1-016080-LED  
c. 1-016080 8 LS

H 80 x B 80 cm

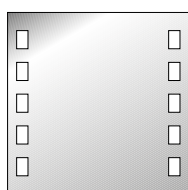

a. 1-018080-LED  
c. 1-018080 10 LS

H 90 x B 50 cm

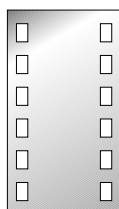

a. 1-019050-LED  
c. 1-019050 12 LS

H 90 x B 60 cm

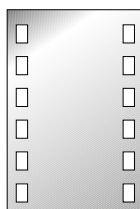

a. 1-019060-LED  
c. 1-019060 12 LS

H 90 x B 70 cm

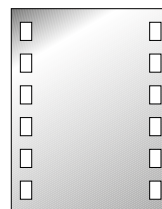

a. 1-019070-LED  
c. 1-019070 12 LS

H 100 x B 60 cm

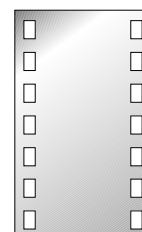

a. 1-0110060-LED  
c. 1-0110060 14 LS

### Leuchtmittel Lamps

- a. LED  
19W/m, ~1.500lm
- b. T5 Leuchtstofflampe  
80 lm/Watt
- c. Halogen  
10W, ~140lm/  
Leuchtstelle (LS)









# Visagist

Auf dieser Seite zeigen wir Ihnen Designbeispiele, damit Sie sehen, wie vielfältig der Visagist ist. Vielleicht finden Sie unter den vielen Anregungen auch Ihren Traumspiegel (H x B).

On this page, we would like to demonstrate what a versatile mirror the visagist is. You might find your dream mirror among the samples below (h x w).

H 70 x B 45 cm

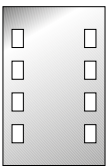

a. 1-0170451-S-LED  
c. 1-0170451-S

H 70 x B 80 cm

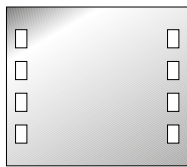

a. 1-017080-S-LED  
c. 1-017080-S

H 60 x B 80 cm

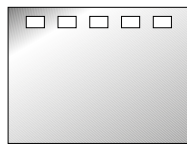

a. 1-0160802-S-LED  
c. 1-0160802-S

H 90 x B 60 cm

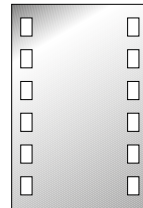

a. 1-019060-S-LED  
c. 1-019060-S

H 60 x B 60 cm

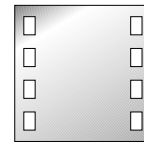

a. 1-016060-S-LED  
c. 1-016060-S

H 140 x B 50 cm

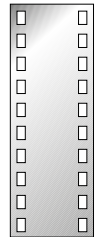

a. 1-0114050-S-LED  
c. 1-0114050-S

H 80 x B 150 cm



a. 1-0180150-S-LED  
c. 1-0180150-S

H 80 x B 120 cm



a. 1-0180120-S-LED  
c. 1-0180120-S

ø 70 cm

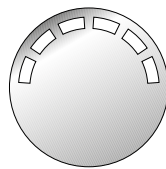

a. 1-0170-S-LED  
c. 1-0170-S

H 66 x B 80 cm  
Bogenhöhe 6 cm  
Arch rise 6 cm

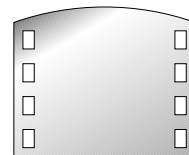

a. 1-016680-S-LED  
c. 1-016680-S

H 86 x B 80 cm  
Bogenhöhe 6 cm  
Arch rise 6 cm

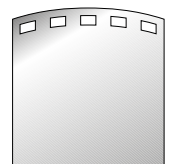

a. 1-018680-S-LED  
c. 1-018680-S

**Leuchtmittel Lamps**

a. LED  
19W/m, ~1.500lm

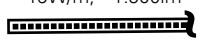

b. T5 Leuchtstofflampe  
80 lm/Watt

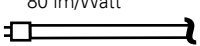

c. Halogen  
10W, ~140lm/  
Leuchtstelle (LS)

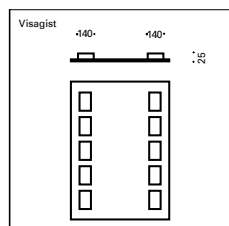
Kristallspiegel  
satiniert, Kanten ge-  
schliffen und poliert,  
Blockmuster, inkl.  
Leuchtmittel.

Glazed crystal mirror  
with smoothed and  
polished edges, block  
pattern design, incl.  
lamps.

LED LED: **A\***

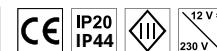

T5 Leuchtstofflampe: **A**



Halogen G4/QT-LP9: **D**







# FineLine

Die Kristallspiegel sind satiniert, die Kanten geschliffen und poliert, mit Streifenmuster, inkl. Leuchtmittel LED, T5 oder G4 klar, gefertigt nach deutscher Spiegelnorm.

Glazed crystal mirror with smoothed and polished edges, striped pattern design, including LED, T5 or clear G4 lamps. Manufactured according to German mirror standards.



FineLine Doppelwaschtisch

### Sondergrößen:

Wir fertigen nach Maß, in LED-Power, Halogentechnik oder T5-Neontechnik (Satinierung richtet sich nach Leuchtmittellänge) in IP 20 oder IP 44.

### Special sizes:

We manufacture to any size with LED-Power, halogen technology or T5 neon technology (satin finish depends on lamp length) in IP 20 or IP 44.

### Standardgrößen (H x B) Standard sizes (h x w)

H 60 x B 45 cm

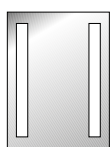

a. 1-026045-LED  
c. 1-026045 8 LS

H 80 x B 40 cm



a. 1-028040-LED  
c. 1-028040 10 LS

H 70 x B 50 cm

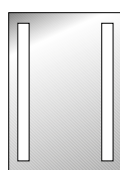

a. 1-027050-LED  
c. 1-027050 10 LS

H 70 x B 70 cm

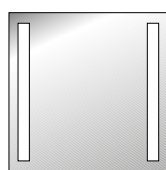

a. 1-027070-LED  
c. 1-027070 10 LS

H 80 x B 60 cm

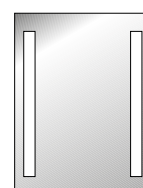

a. 1-028060-LED  
c. 1-028060 10 LS

H 60 x B 80 cm

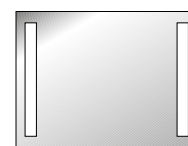

a. 1-026080-LED  
c. 1-026080 8 LS

H 80 x B 80 cm

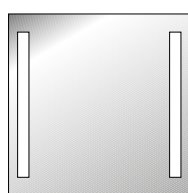

a. 1-028080-LED  
c. 1-028080 10 LS

H 90 x B 50 cm

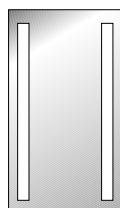

a. 1-029050-LED  
c. 1-029050 12 LS

H 90 x B 60 cm

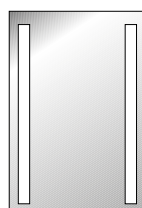

a. 1-029060-LED  
c. 1-029060 12 LS

H 90 x B 70 cm

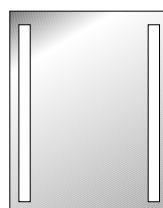

a. 1-029070-LED  
c. 1-029070 12 LS

H 100 x B 60 cm

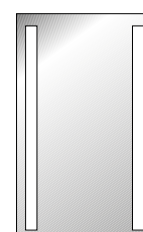

a. 1-0210060-LED  
c. 1-0210060 12 LS

### Leuchtmittel Lamps

- a. LED  
19W/m, ~1.500lm
- b. T5 Leuchtstofflampe  
80 lm/Watt
- c. Halogen  
10W, ~140lm/  
Leuchtstelle (LS)







FineLine

#### Sonderformen:

Zusätzlich zu den Standardgrößen fertigen wir auch besondere Formen des Visagist, FineLine und SightLight. Ganz nach Ihren Vorstellungen - von der Bogenform bis zur Dachschrägenaussparung. Beispiele finden Sie in der Preisliste.

#### Special shapes:

In addition to the standard sizes of the Visagist, FineLine and SightLight we also manufacture special shapes. According to your demands varying from arch shapes to droop cut-outs. Check our price list for examples.



# FineLine

Hier sehen Sie Designbeispiele des Modells FineLine. Vielleicht finden Sie unter den vielen Anregungen auch Ihren Traumspiegel (H x B).

Below we present some design samples of the FineLine model. You might find your dream mirror among them (h x w).

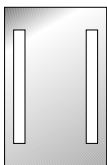
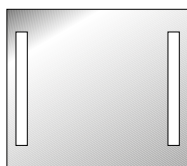
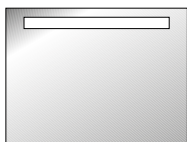
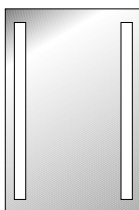
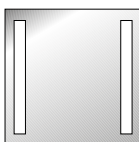
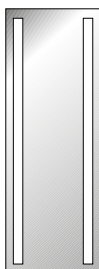
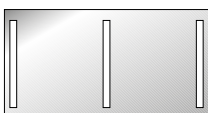
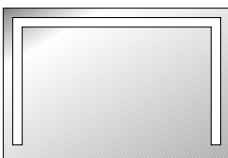
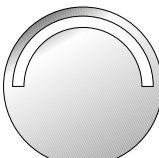
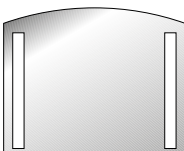
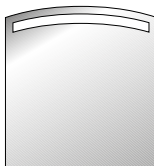
H 70 x B 45 cm 	H 70 x B 80 cm 	H 60 x B 80 cm 	H 90 x B 60 cm 	H 60 x B 60 cm 	H 140 x B 50 cm 
a. 1-0270451-S-LED c. 1-0270451-S	a. 1-027080-S-LED c. 1-027080-S	a. 1-0260802-S-LED c. 1-0260802-S	a. 1-029060-S-LED c. 1-029060-S	a. 1-026060-S-LED c. 1-026060-S	a. 1-0214050-S-LED c. 1-0214050-S
H 80 x B 150 cm 	H 80 x B 120 cm 	ø 70 cm 	H 66 x B 80 cm Bogenhöhe 6 cm Arch rise 6 cm 	H 86 x B 80 cm Bogenhöhe 6 cm Arch rise 6 cm 	
a. 1-0280150-S-LED c. 1-0280150-S	a. 1-0280120-S-LED c. 1-0280120-S	a. 1-0270-S-LED c. 1-0270-S	a. 1-026680-S-LED c. 1-026680-S	a. 1-028680-S-LED c. 1-028680-S	

**Leuchtmittel Lamps**

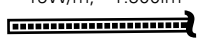
a. LED  
19W/m, ~1.500lm  

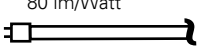
b. T5 Leuchtstofflampe  
80 lm/Watt  



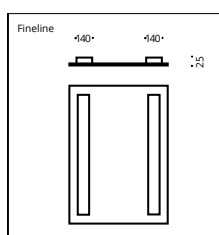

c. Halogen  
10W, ~140lm/  
Leuchtstelle (LS)  



Kristallspiegel  
satiniert, Kanten geschliffen und poliert,  
Streifenmuster, inkl.

Leuchtmittel. Gefertigt nach Deutscher Spiegelnorm.

Glazed crystal mirror with smoothed and polished edges, striped pattern design, incl. lamps. Manufactured according to German mirror standards.

LED LED: <b>A<sup>+</sup></b>	CE	IP20 IP44		12 V = 230 V
T5 Leuchtstofflampe: <b>A</b>	CE	IP20 IP44		1-10V DALI  xx/yyW MULTI
Halogen G4/QT-LP9: <b>D</b>	CE	IP20 IP44		12 V = 230 V





# SideLight

Die Kristallspiegel sind satiniert, die Kanten geschliffen und poliert, mit Streifenmuster, inkl. Leuchtmittel LED oder G4 klar, gefertigt nach deutscher Spiegelnorm.

Glazed crystal mirror with smoothed and polished edges, striped pattern design, including LED or clear G4 lamps. Manufactured according to German mirror standards.



SideLight

**Sondergrößen:**  
Wir fertigen nach Maß, LED-Power oder in Halogentechnik.

**Special sizes:**  
We manufacture to any size with LED-Power or halogen technology.

## Standardgrößen (H x B) Standard sizes (h x w)

H 60 x B 45 cm

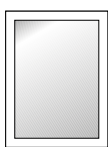

a. 1-036045-LED  
c. 1-036045 15 LS

H 80 x B 40 cm



a. 1-038040-LED  
c. 1-038040 16 LS

H 70 x B 50 cm

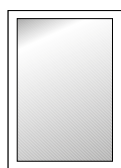

a. 1-037050-LED  
c. 1-037050 16 LS

H 70 x B 70 cm

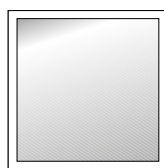

a. 1-037070-LED  
c. 1-037070 16 LS

H 80 x B 60 cm

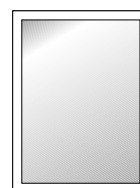

a. 1-038060-LED  
c. 1-038060 18 LS

H 60 x B 80 cm

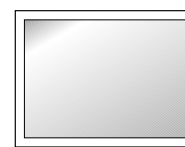

a. 1-036080-LED  
c. 1-036080 18 LS

H 80 x B 80 cm

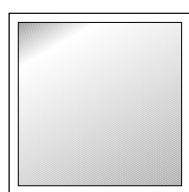

a. 1-038080-LED  
c. 1-038080 20 LS

H 90 x B 50 cm

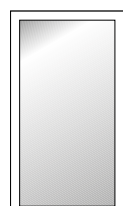

a. 1-039050-LED  
c. 1-039050 18 LS

H 90 x B 60 cm

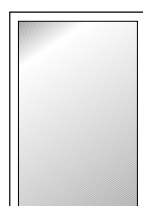

a. 1-039060-LED  
c. 1-039060 20 LS

H 90 x B 70 cm

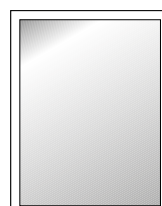

a. 1-039070-LED  
c. 1-039070 20 LS

H 100 x B 60 cm



a. 1-0310060-LED  
c. 1-0310060 20 LS

### Leuchtmittel Lamps

a. LED  
19W/m, ~1.500lm

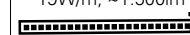

c. Halogen  
10W, ~140lm/  
Leuchtstelle (LS)







SideLight LED



# SideLight

Hier sehen Sie eine Vielzahl von Designbeispielen des SideLight. Vielleicht finden Sie unter den vielen Anregungen auch Ihren Traumspiegel (H x B).

Below we present some design samples of the SideLight model. You might find your dream mirror among them (h x w).

H 70 x B 45 cm

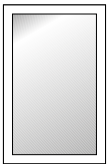

a. 1-0370451-S-LED  
c. 1-0370451-S

H 70 x B 80 cm

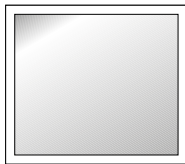

a. 1-037080-S-LED  
c. 1-037080-S

H 60 x B 80 cm



a. 1-0360802-S-LED  
c. 1-0360802-S

H 90 x B 60 cm



a. 1-039060-S-LED  
c. 1-039060-S

H 60 x B 60 cm

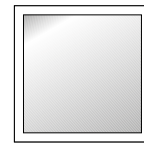

a. 1-036060-S-LED  
c. 1-036060-S

H 140 x B 50 cm



a. 1-0314050-S-LED  
c. 1-0314050-S

H 80 x B 150 cm

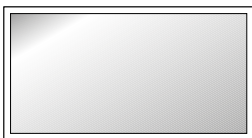

a. 1-0380150-S-LED  
c. 1-0380150-S

H 80 x B 120 cm

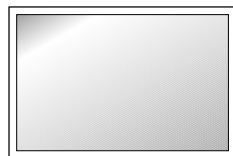

a. 1-0380120-S-LED  
c. 1-0380120-S

ø 70 cm

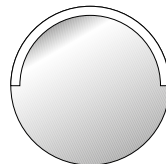

a. 1-03702-S-LED  
c. 1-03702-S

H 66 x B 80 cm  
Bogenhöhe 6 cm  
Arch rise 6 cm

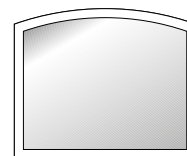

a. 1-036680-S-LED  
c. 1-036680-S

H 86 x B 80 cm  
Bogenhöhe 6 cm  
Arch rise 6 cm

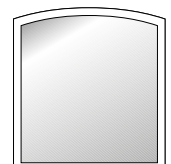

a. 1-038680-S-LED  
c. 1-038680-S

**Leuchtmittel Lamps**

a. LED  
19W/m, ~1.500lm

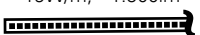

c. Halogen  
10W, ~140lm/  
Leuchtstelle (LS)

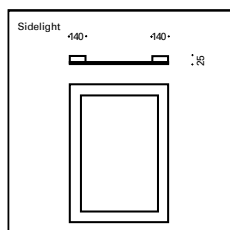



Kristallspiegel satiniert, Kanten geschliffen und poliert, Streifenmuster, inkl. Leuchtmittel.

Glazed crystal mirror with smoothed and polished edges, striped pattern design, including lamps.

LED LED: **A+**

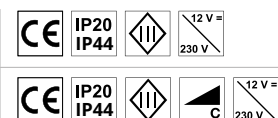
Halogen G4/QT-LP9: **D**







# DotLight

Die Kristallspiegel sind satiniert, die Kanten geschliffen und poliert, mit Punktmuster, inkl. Leuchtmittel LED, T5 oder G4 klar, gefertigt nach deutscher Spiegelnorm.

Glazed crystal mirrors with smoothed and polished edges, dotted pattern design, including LED, T5 or clear G4 lamps. Manufactured according to German mirror standards.



### Sondergrößen:

Wir fertigen nach Maß, in LED-Power, Halogentechnik oder T5-Neontechnik (Satinierung richtet sich nach Leuchtmittellänge) in IP 20 oder IP 44.

### Special sizes:

We manufacture to any size with LED-Power, halogen technology or T5 neon technology (satin finish depends on lamp length) in IP 20 or IP 44.



## Standardgrößen (H x B) Standard sizes (h x w)

H 60 x B 45 cm

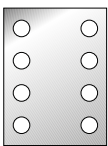

a. 1-056045-LED  
c. 1-056045 8 LS

H 80 x B 40 cm

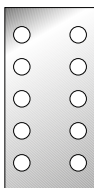

a. 1-058040-LED  
c. 1-058040 10 LS

H 70 x B 50 cm

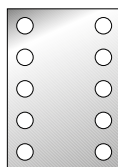

a. 1-057050-LED  
c. 1-057050 10 LS

H 70 x B 70 cm

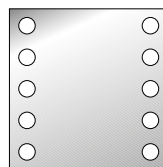

a. 1-057070-LED  
c. 1-057070 10 LS

H 80 x B 60 cm

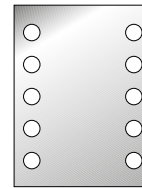

a. 1-058060-LED  
c. 1-058060 10 LS

H 60 x B 80 cm

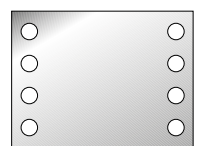

a. 1-056080-LED  
c. 1-056080 8 LS

H 80 x B 80 cm

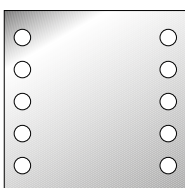

a. 1-058080-LED  
c. 1-058080 10 LS

H 90 x B 50 cm

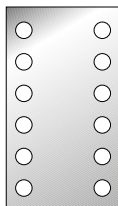

a. 1-059050-LED  
c. 1-059050 12 LS

H 90 x B 60 cm

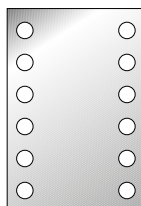

a. 1-059060-LED  
c. 1-059060 12 LS

H 90 x B 70 cm

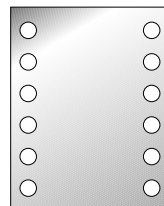

a. 1-059070-LED  
c. 1-059070 12 LS

H 100 x B 60 cm

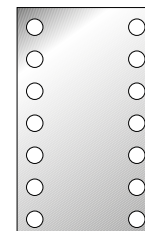

a. 1-0510060-LED  
c. 1-0510060 14 LS

**Leuchtmittel Lamps**

a. LED  
19W/m, ~1.500lm

b. T5 Leuchtstofflampe  
80 lm/Watt

c. Halogen  
10W, ~140lm/  
Leuchtstelle (LS)









# DotLight

Auf dieser Seite zeigen wir Ihnen Designbeispiele um darzustellen, wie vielfältig der DotLight ist. Vielleicht finden Sie unter den vielen Anregungen auch Ihren Traumspiegel (H x B).

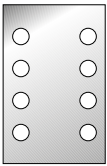
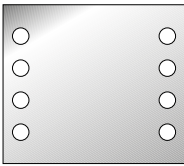
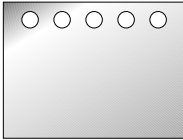
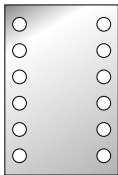
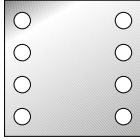
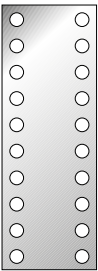
On this page, we would like to demonstrate what a versatile mirror the DotLight model is. You might find your dream mirror among the samples below (h x w).

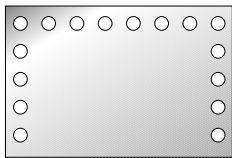
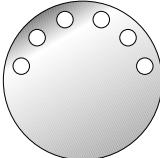
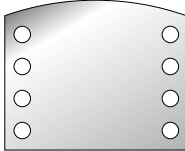
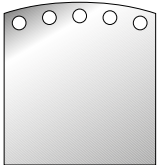
<p>H 70 x B 45 cm</p>  <p>a. 1-0570451-S-LED c. 1-0570451-S</p>	<p>H 70 x B 80 cm</p>  <p>a. 1-057080-S-LED c. 1-057080-S</p>	<p>H 60 x B 80 cm</p>  <p>a. 1-0560802-S-LED c. 1-0560802-S</p>	<p>H 90 x B 60 cm</p>  <p>a. 1-059060-S-LED c. 1-059060-S</p>	<p>H 60 x B 60 cm</p>  <p>a. 1-056060-S-LED c. 1-056060-S</p>	<p>H 140 x B 50 cm</p>  <p>a. 1-0514050-LED c. 1-0514050</p>
<p>H 80 x B 150 cm</p>  <p>a. 1-0580150-S-LED c. 1-0580150-S</p>	<p>H 80 x B 120 cm</p>  <p>a. 1-0580120-S-LED c. 1-0580120-S</p>	<p>ø 70 cm</p>  <p>a. 1-0570-S-LED c. 1-0570-S</p>	<p>H 66 x B 80 cm Bogenhöhe 6 cm Arche rise 6 cm</p>  <p>a. 1-056680-S-LED c. 1-056680-S</p>	<p>H 86 x B 80 cm Bogenhöhe 6 cm Arche rise 6 cm</p>  <p>a. 1-058680-S-LED c. 1-058680-S</p>	

**Leuchtmittel Lamps**

a. LED  
19W/m, ~1.500lm



b. T5 Leuchtstofflampe  
80 lm/Watt

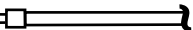

c. Halogen  
10W, ~140lm/  
Leuchtstelle (LS)

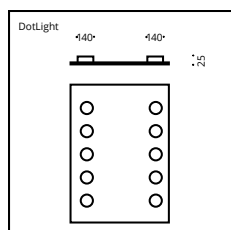
LED LED: <b>A*</b>	CE	IP20 IP44	III	12 V = 230 V
T5 Leuchtstofflampe: <b>A</b>	CE	IP20 IP44	III	1-10V DALI xx/yy W MULTI
Halogen G4/QT-LP9: <b>D</b>	CE	IP20 IP44	III	12 V = 230 V







# BrightLight

Die Kristallspiegel sind satiniert, die Kanten geschliffen und poliert, inkl. Leuchtmittel LED oder G4 klar, gefertigt nach deutscher Spiegelnorm.

Glazed crystal mirrors with smoothed and polished edges, dotted pattern design, including LED or clear G4 lamps. Manufactured according to German mirror standards.



BrightLight









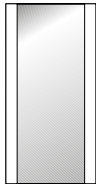

### Sondergrößen:

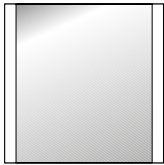
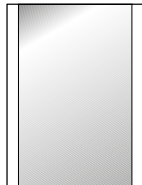
Wir fertigen nach Maß, in LED-Power oder Halogentechnik in IP 20.

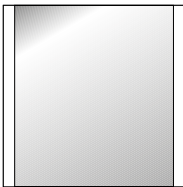
### Special sizes:

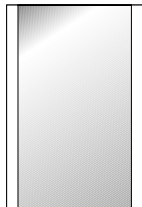
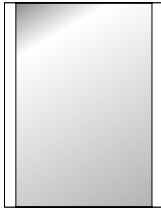
We manufacture to any size with LED-Power or halogen technology in IP 20.

## Standardgrößen (H x B) Standard sizes (h x w)

H 60 x B 45 cm  a. 1-066045-LED c. 1-066045 10 LS	H 80 x B 40 cm  a. 1-068040-LED c. 1-068040 12 LSt	H 70 x B 50 cm  a. 1-067050-LED c. 1-067050 12 LS	H 70 x B 70 cm  a. 1-067070-LED c. 1-067070 12 LS	H 80 x B 60 cm  a. 1-068060-LED c. 1-068060 12 LS	H 60 x B 80 cm  a. 1-066080-LED c. 1-066080 8 LS
H 80 x B 80 cm  a. 1-068080-LED c. 1-068080 12 LS	H 90 x B 50 cm  a. 1-069050-LED c. 1-069050 14 LS	H 90 x B 60 cm  a. 1-069060-LED c. 1-069060 14 LS	H 90 x B 70 cm  a. 1-069070-LED c. 1-069070 14 LS	H 100 x B 60 cm  a. 1-0610060-LED c. 1-0610060 14 LS	<div style="border: 1px solid black; padding: 5px;"> <p><b>Leuchtmittel Lamps</b></p> <p>a. LED 19W/m, ~1.500lm </p> <p>c. Halogen 10W, ~140lm/ Leuchtstelle (LS) </p> </div>









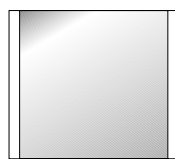
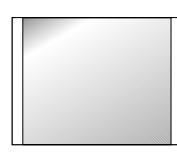

# BrightLight

Auf dieser Seite zeigen wir Ihnen Designbeispiele um darzustellen, wie vielfältig der BrightLight ist. Vielleicht finden Sie unter den vielen Anregungen auch Ihren Traumspiegel (H x B).

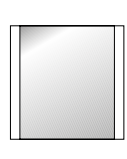
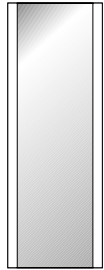
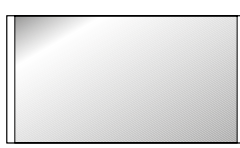
On this page, we would like to show you some design samples to demonstrate what a versatile mirror the BrightLight is. You might find your dream mirror among the samples below (h x w).

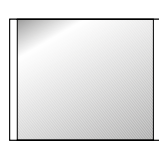
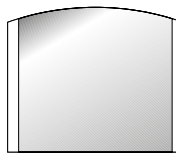
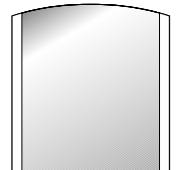
<p>H 70 x B 45 cm</p>  <p>a. 1-0670451-S-LED c. 1-0670451-S</p>	<p>H 70 x B 80 cm</p>  <p>a. 1-067080-S-LED c. 1-067080-S</p>	<p>H 60 x B 80 cm</p>  <p>a. 1-0660802-S-LED c. 1-0660802-S</p>	<p>H 90 x B 60 cm</p>  <p>a. 1-069060-S-LED c. 1-069060-S</p>	<p>H 60 x B 60 cm</p>  <p>a. 1-066060-S-LED c. 1-066060-S</p>	<p>H 140 x B 50 cm</p>  <p>a. 1-0614050-S-LED c. 1-0614050-S</p>
<p>H 80 x B 150 cm</p>  <p>a. 1-0680150-S-LED c. 1-0680150-S</p>	<p>H 80 x B 120 cm</p>  <p>a. 1-0680120-S-LED c. 1-0680120-S</p>	<p>H 80 x B 100 cm</p>  <p>a. 1-0680100-S-LED c. 1-0680100-S</p>	<p>H 66 x B 80 cm Bogenhöhe 6 cm Arche rise 6 cm</p>  <p>a. 1-066680-S-LED c. 1-066680-S</p>	<p>H 86 x B 80 cm Bogenhöhe 6 cm Arche rise 6 cm</p>  <p>a. 1-068680-S-LED c. 1-068680-S</p>	

**Leuchtmittel Lamps**

a. LED  
19W/m, ~1.500lm



c. Halogen  
10W, ~140lm/  
Leuchtstelle (LS)



Kristallspiegel satiniert, Kanten geschliffen und poliert, Streifenmuster, inkl. Leuchtmittel.

Glazed crystal mirror with smoothed and polished edges, striped pattern design, including lamps.

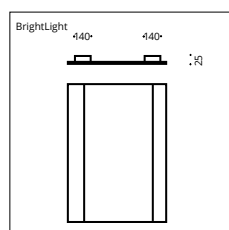

LED LED: A+

Halogen G4/QT-LP9: D

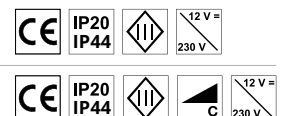





# InLight

Kristallspiegel, geschliffene und polierte Kanten, indirektes Licht, inkl. Leuchtmittel LED oder T5 Leuchtstoffröhre, gefertigt nach deutscher Spiegelnorm.

Glazed crystal mirror, indirect lighting, including LED or T5 fluorescent lamp. Manufactured according to German mirror standards.



InLight

## Sondergrößen:

Wir fertigen nach Maß, in LED-Power, oder T5-Neontechnik (Satinierung richtet sich nach Leuchtmittellänge) in IP 20.

## Special sizes:

We manufacture to any size with LED-Power, or T5 neon technology (satin finish depends on lamp length) in IP 20 or.

## Standardgrößen (H x B) Standard sizes (h x w)

H 60 x B 45 cm

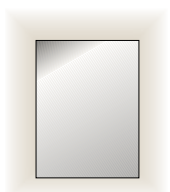

a. 1-076045-LED  
b. 1-076045 2 x 24W

H 80 x B 40 cm



a. 1-078040-LED  
b. 1-078040 2 x 24W

H 70 x B 50 cm



a. 1-077050-LED  
b. 1-077050 2 x 24W

H 70 x B 70 cm



a. 1-077070-LED  
b. 1-077070 4 x 24W

H 80 x B 60 cm



a. 1-078060-LED  
b. 1-078060 4 x 24W

H 60 x B 80 cm

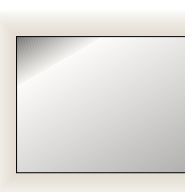

a. 1-076080-LED  
b. 1-076080 4 x 24W

H 80 x B 80 cm

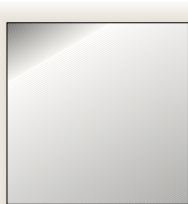

a. 1-078080-LED  
b. 1-078080 4 x 24W

H 90 x B 50 cm



a. 1-079050-LED  
b. 1-079050 2 x 24W

H 90 x B 60 cm



a. 1-079060-LED  
b. 1-079060 4 x 24W

H 90 x B 70 cm



a. 1-079070-LED  
b. 1-079070 4 x 24W

H 100 x B 60 cm



a. 1-0710060-LED  
b. 1-0710060 2x21 + 2x24W

## Leuchtmittel Lamps

a. LED  
19W/m, ~1.500lm

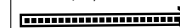

b. T5 Leuchtstofflampe  
80 lm/Watt

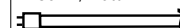

c. Halogen  
10W, ~140lm/  
Leuchtstelle (LS)









# InLight

Auf dieser Seite zeigen wir Ihnen Designbeispiele damit Sie sehen, wie vielfältig der InLight ist. Vielleicht finden Sie unter den vielen Anregungen auch Ihren Traumspiegel (H x B).

On this page, we would like to show you some design samples to demonstrate what a versatile mirror the InLight is. You might find your dream mirror among the samples below (h x b).



Kristallspiegel satiniert, Kanten geschliffen und poliert, inkl. Leuchtmittel.

Glazed crystal mirror with smoothed and polished edges, including lamps.

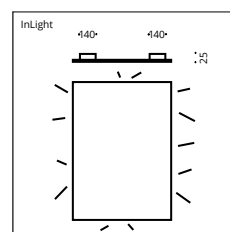

InLight

H 80 x B 120 cm

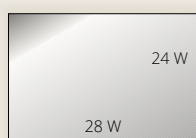

a. 1-0780120-S-LED  
b. 1-0780120-S

H 100 x B 100 cm

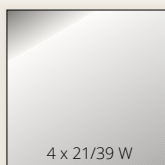

a. 1-07100100-S-LED  
b. 1-07100100-S

H 70 x B 150 cm

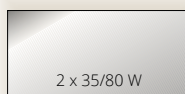

a. 1-0770150-S-LED  
b. 1-0770150-S

H 70 x B 160 cm

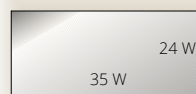

a. 1-0770160-S-LED  
b. 1-0770160-S

H 80 x B 100 cm

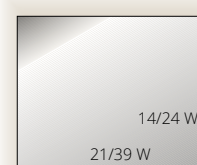

a. 1-0780100-S-LED  
b. 1-0780100-S

H 90 x B 60 cm



a. 1-079060-S-LED  
b. 1-079060-S

H 85 x B 120 cm  
Bogenhöhe 5 cm  
Arch rise 5 cm

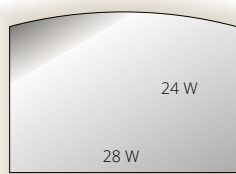

a. 1-0785120-S-LED  
b. 1-0785120-S

H 140 x B 50 cm



a. 1-0714050-S-LED  
b. 1-0714050-S

LED LED: **A\***

T5 Leuchtstofflampe:

**A**

Halogen G4/QT-LP9:

**D**

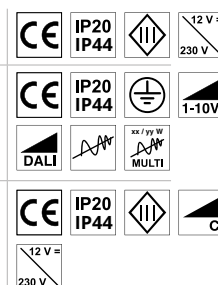

Leuchtmittel Lamps

a. LED

19W/m, ~1.500lm



b. T5 Leuchtstofflampe

80 lm/Watt

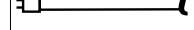

c. Halogen

10W, ~140lm/

Leuchtstelle (LS)



Hochvolt Halogen, IP 44! Leuchtmittelwartung von vorne!  
High voltage halogen, IP 44! Maintenance from the front side.





# BulbLine

Der klassische Halogenlichtspiegel mit seinen Lichtkugeln in Opalglasausführung bietet Ihnen viel Gestaltungsraum, um Ihre eigenen Vorstellungen perfekt umzusetzen. Designen Sie Ihren eigenen Spiegel, ganz nach Ihren Wünschen!

The classic halogen illuminated mirror with its light bulbs in opal glass design allows a lot of room for your creativity. Design your own mirror according to your imagination to fulfill your wishes!

- 1** Nehmen Sie Maß. Bestimmen Sie die Größe Ihres Wunschspiegels.  
Wir fertigen nach Maß!  
Take the measurement. Determine the size of your desired mirror.  
We manufacture to any size!

- 2** Formänderung und Veredelung  
Modification and dressing

Art.-Nr./Item-No.

Eckabschnitte  
beliebige  
Anzahl  
Corner cuts:  
any number  
**0-0400**

Formen (Beispiele):  
Shapes (examples):

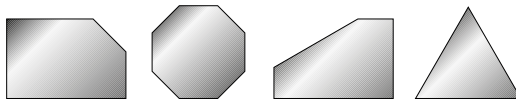

Abrundungen  
beliebige  
Anzahl  
roundings:  
any number  
**0-0500**

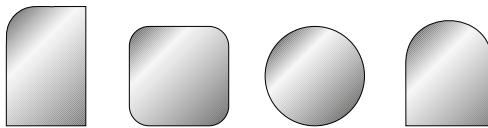

Facettenschliff  
20 mm  
umlaufend  
facets  
20 mm all round  
**0-0619**

Veredelung, finish:

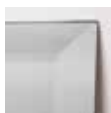

- 3** Zubehör Accessories

Steckdose  
Aufbau\*, chrom  
socket, surface  
mounted, chrome  
**1-00882**



\* Bohrlochdurchmesser (borehole)  
ø = 50 mm

Schalter  
Aufbau\*, chrom  
switch, surface  
mounted, chrome  
**1-00872**



\* Bohrlochdurchmesser (borehole)  
ø = 50 mm

- 4** Bestimmen Sie die Anzahl\* der Leuchtstellen:  
Determine the number of places\* of illumination spots:

Opalglasausführung,  
Opal glass design  
60 mm Kugel, 60 mm bulb  
20W G9  
inkl. Bohrloch, incl. borehole  
**2-0501**



\* Empfohlener Abstand der Lampen zueinander: 170-220 mm,  
Randabstand mind. 60 mm! Bohrloch ø = 24 mm.

\* Recommended spacing between lamps: 170-220 mm, edge  
distance minimum 60mm! Borehole ø = 24 mm.



Lichtkugeln mit unsichtbarer  
Befestigung, Spiegelstärke 6 mm,  
Wandabstand 10 mm

Light bulbs with invisible fasten-  
ing, mirror thickness 6 mm, wall  
spacing 10 mm.







# BulbLine

Auf dieser Seite zeigen wir Ihnen Designbeispiele um darzustellen, wie vielfältig der BulbLine ist. Vielleicht finden Sie unter den vielen Anregungen auch Ihren Traumspiegel (H x B).

On this page, we show you some design samples to demonstrate what a versatile mirror the BulbLine is. You might find your dream mirror among the samples below (h x b).

H 80 x B 60 cm

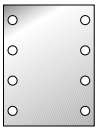

c. 1-0480608-o

H 70 x B 45 cm

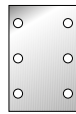

c. 1-0470456-o

H 60 x B 80 cm

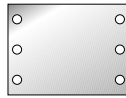

c. 1-0460806-o

H 60 x B 80 cm

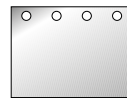

c. 1-0460804-o

H 90 x B 50 cm

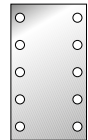

c. 1-04905010-o

H 80 x B 70 cm

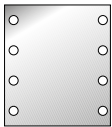

c. 1-0480708-o

H 80 x B 80 cm

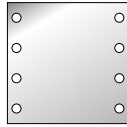

c. 1-0480808-o

H 80 x B 120 cm

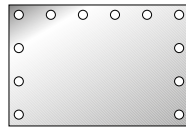

c. 1-048012012-o

H 80 x B 150 cm

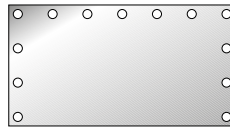

c. 1-048015013-o

H 80 x B 100 cm

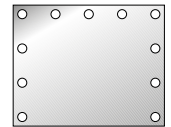

c. 1-048010011-o

H 80 x B 150 cm

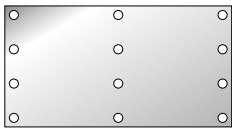

c. 1-048015012-o

H 80 x B 80 cm

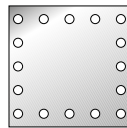

c. 1-04808016-o

ø 70 cm

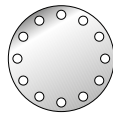

c. 1-047012-o

ø 70 cm

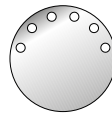

c. 1-04706-o

H 65 x B 80 cm  
Bogenhöhe 6 cm  
Arch rise 6 cm

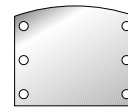

c. 1-0465806-o-B

H 85 x B 80 cm  
Bogenhöhe 6 cm  
Arch rise 6 cm

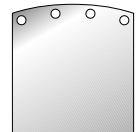

c. 1-0485804-o-B

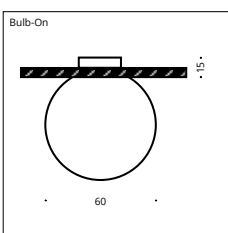

Der Wandabstand beträgt normal 10 mm. Achtung: erhöhter Wandabstand von 35 mm bei integriertem Steckdosenaufbau.

The wall spacing is normally 10 mm. Attention: Increased wall spacing with surface mounted socket (35mm)!

Halogen G4/QT-LP9: **D**  
20W ECO ~200lm ~2.800k

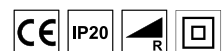







# Circle

Circle ist ein runder Lichtspiegel in satiniertem Kristallglas, inkl. Leuchtmittel LED oder G4 klar, gefertigt nach deutscher Spiegelnorm.

The Circle model is a round illuminated mirror made of glazed crystal glass including LED or G4 clear lamps. Manufactured according to German mirror standards.



DotCircle



SideCircle

## Standardgrößen, standard sizes

VisaCircle Ø 70 cm



a. 1-0370-LED / c. 1-0370

FineCircle Ø 70 cm



a. 1-03701-LED / c. 1-03701

DotCircle Ø 70 cm



a. 1-03702-LED / c. 1-03702

SideCircle Ø 70 cm



a. 1-03703-LED / c. 1-03703

**Leuchtmittel Lamps**

a. LED  
19W/m, ~1.500lm

b. T5 Leuchtstofflampe  
80 lm/Watt

c. Halogen  
10W, ~140lm/  
Leuchtstelle (LS)

Zusätzlich zur Standardgröße fertigen wir den Circle auch in Sondergrößen mit LED-Power oder Halogentechnik.

In addition to the standard sizes, we also manufacture the Circle model in special sizes with LED-Power or halogen technology.

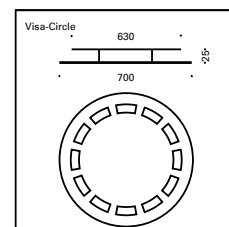

LED LED: <b>A+</b>	CE	IP20 IP44	12 V = 230 V
T5 Leuchtstofflampe: <b>A</b>	CE	IP20 IP44	1-10V DALI xx/yy W MULTI
Halogen G4/QT-LP9: <b>D</b>	CE	IP20 IP44	12 V = 230 V







# Vision

Der Raumteiler (Sonderanfertigung) ist erhältlich als Visagist, Fineline, BrightLight oder DotLight, beidseitiger Kristallspiegel satiniert, Kanten geschliffen und poliert, inkl. Leuchtmittel, VA gebürstet.

The partition (custom-made product) is available as Visagst, FineLine or DotLight. Both-sided glazed crystal mirror with smoothed and polished edges. Including lamps, base frame brushed VA.



Aufbauversion  
Surface mounting version



Einbauversion  
Recessed fitting version



Vision Aufbauversion, Surface mounting version

Art. Nr. item-no.	Ausführung design
1-00103	Aufbauversion surface mounting version
1-00104	Einbauversion recessed fitting version

## Sondergrößen:

Wir fertigen nach Maß, in LED-Power, oder T5-Neontechnik (Satinierung richtet sich nach Leuchtmittellänge) in IP 20 oder IP 44.

## Special sizes:

We manufacture to any size with LED-Power, or T5 neon technology (satin finish depends on lamp length) in IP 20 or IP 44.

**Leuchtmittel Lamps**

a. LED  
19W/m, ~1.500lm

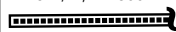

b. T5 Leuchtstofflampe  
80 lm/Watt

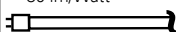

c. Halogen  
10W, ~140lm/  
Leuchtstelle (LS)

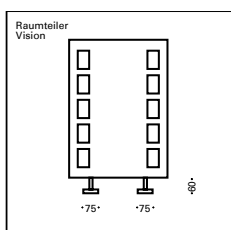
LED LED: **A\***

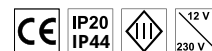

T5 Leuchtstofflampe: **A**



Halogen G4/QT-LP9: **D**







## Lichtspiegel Doppelwaschtisch

Illuminated Mirror double wash basin





# Ornaments

## LEO Print Design Lichtspiegel

Ein außerordentliches Design für alle Modelle. Ornamente sind auf Wunsch und nach Vorlage möglich! Die Kristallspiegel sind satiniert, die Kanten geschliffen und poliert, jedes Muster ist möglich, inkl. Leuchtmittel LED, T5 oder G4 klar. Spiegel gefertigt nach deutscher Spiegelnorm.

## Illuminated mirror in leo-print design

An extraordinary design for all models. Ornaments are possible by request and according to master. The crystal mirrors are glazed, the edges are smoothed and polished. Any pattern is possible. Including LED T5 or clear G4 lamps. Mirrors manufactured according to German mirror standards.



Leoprint



### Sondergrößen:

Wir fertigen nach Maß, in LED-Power, oder T5-Neontechnik (Satinierung richtet sich nach Leuchtmittellänge) in IP 21 oder IP 44.

### Special sizes:

We manufacture to any size with LED-Power, or T5 neon technology (frosting depends on lamp length) in IP 21 or IP 44.





Lichtstange chrommatt

# Badspiegelleuchten (für Spiegelan-, Spiegelauf- und Spiegeleinbau)

## Mirror Lamps (for mirror mounting)



Bulb Strip 175



Better, Better Fix, Better Mirror 177



HotLine Basic, HotLine Take Two 179

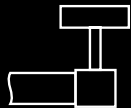

HotLine - EasySystem 180



Lichtstange 181 – 183  
Lichtstange Klemmi

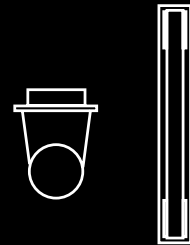

Two Socket, Two Socket Base 185  
Two Socket Fix  
Two Socket Base Fix

Diese Leuchten finden Sie unter: Wohnraum-, Bad- & Objektleuchten für die Wand & Puk World

You can find this lamps at: Living room, bath & object lighting for the wall & Puk World



Lens Mirror 193



Focus 100 Mirror 197

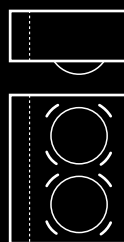

Focus 150 Mirror 199



Puk Fix & Puk Fix + 21



Puk Mirror & Puk Mirror + 23



Puk Maxx Fix 67  
& Puk Maxx Fix +



Puk Maxx Mirror 69  
& Puk Maxx Mirror +



BulbStrip Top Five



# BulbStrip

Diese Wandleuchte mit Lichtkugeln in Opalglasausführung, ist superflach (nur 15 mm), mit integrierter Steckdose (nur 35 mm), in chrom oder nickelmatt, optional mit Spiegelklemmen.

This wall light with light bulbs in opal is super flat (only 15 mm), with integrated socket (only 35 mm), available in nickel matt or chrome, optional with mirror clamps.



Top Three & Fix me





Top Three





Bulb in weiß  
Bulb in white



Bulb mit Steckdose  
Bulb with socket

Top Three G9/QT14:  ~2.700k	H x B x T h x w x d	Top Five G9/QT14:  ~2.700k	H x B x T h x w x d	Ausführung – Superflach, nur 15 mm! design – super flat, only 15 mm!
2-05351 3 x 20W Eco, ~705lm	35 x 6 x 1,5 cm	2-05601 5 x 20W Eco, ~1.175m	60 x 6 x 1,5 cm	Chromgehäuse in Opalglasausführung chrome body, opal bulbs
2-05352 3 x 20W Eco, ~705lm	35 x 6 x 1,5 cm	2-05602 5 x 20W Eco, ~1.175m	60 x 6 x 1,5 cm	Nickelmattgehäuse in Opalglasausführung brushed nickel, opal bulbs
2-05351-W 3 x 20W Eco, ~705lm	35 x 6 x 1,5 cm	2-05601-W 5 x 20W Eco, ~1.175m	60 x 6 x 1,5 cm	Weiß in Opalglasausführung white body, opal bulbs
2-05351-SW 3 x 20W Eco, ~705lm	35 x 6 x 1,5 cm	2-05601-SW 5 x 20W Eco, ~1.175m	60 x 6 x 1,5 cm	Schwarz in Opalglasausführung black body, opal bulbs

Top Two G9/QT14:  ~2.700k	H x B x T h x w x d	Top Four G9/QT14:  ~2.700k	H x B x T h x w x d	Ausführung – Mit integrierter Steckdose! design – with integrated socket!
2-05351s 2 x 20W Eco, ~470lm	35 x 7 x 3,5 cm	2-05601s 4 x 20W Eco, ~940lm	60 x 7 x 3,5 cm	Chromgehäuse in Opalglasausführung chrome body, opal bulbs
2-05352s 2 x 20W Eco, ~470lm	35 x 7 x 3,5 cm	2-05602s 4 x 20W Eco, ~940lm	60 x 7 x 3,5 cm	Nickelmattgehäuse in Opalglasausführung brushed nickel, opal bulbs
2-05351s-W 2 x 20W Eco, ~470lm	35 x 7 x 3,5 cm	2-05601s-W 4 x 20W Eco, ~940lm	60 x 7 x 3,5 cm	Weiß in Opalglasausführung white body, opal bulbs
2-05351s-SW 2 x 20W Eco, ~470lm	35 x 7 x 3,5 cm	2-05601s-SW 4 x 20W Eco, ~940lm	60 x 7 x 3,5 cm	Schwarz in Opalglasausführung black body, opal bulbs

Fix me Ausführung – Optional für alle Wandleuchten!  
design – optional for all wall lights!

2-541	Klemmenpaar für Spiegelmontage, chrom, pair of clamps for mounting, chrome
2-542	Klemmenpaar für Spiegelmontage, nickelmatt, pair of clamps for mounting, brushed nickel

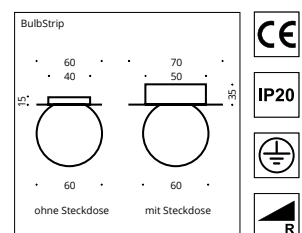





Better Mirror



Better Wall





# Better

Better – Wandanbauleuchte, Better Fix – Spiegelklemmleuchte, Better Mirror – Spiegeleinbauleuchte, mit 360° drehbarem Alurefektor und satiniertem Glas, max. 100 Watt, R7S - 78 mm.

Better – wall mounting lamp, Better Fix – mirror clip lamp, Better Mirror – mirror fitting lamp. With 360° rotatable aluminium baffle and frosted glass, max. 100 watts, R7S – 78mm.



Better Mirror Chrom, Better Mirror chrome



Better Fix Chrom, Better Fix chrome



Better Fix Nickel gebürstet, Better Fix nickel brushed



Better mit schwarzem und weißem Gehäuse  
Better with a black and a white body

Modell model	Halogen R7s 78mm: QT-DE 11/12 D → ~2.900k	Ausführung design
Better 80W Eco, ~1.400lm	2-0731 2-0731-w 2-0731-s 2-0732	chrome white/chrome black/chrome nickel matt
Better Fix 80W Eco, ~1.400lm	2-0741 2-0741-w 2-0741-s 2-0742	chrome white/chrome black/chrome nickel matt
Better Mirror 80W Eco, ~1.400lm	2-0751 2-0751-w 2-0751-s 2-0752	chrome white/chrome black/chrome nickel matt

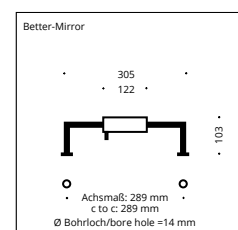
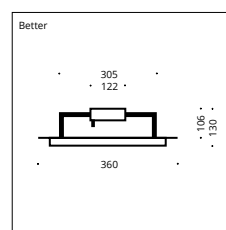



HotLine TakeTwo



HotLine Basic wall



HotLine Basic fix



HotLine Take Two fix mit Reflektor  
HotLine Take Two fix with baffle



# HotLine – Basic & Take Two

Als Spiegeleinbau- (mirror), Wandanbau- (wall) oder Spiegelklemmleuchte (fix), in chrom oder nickelmatt. Lieferbar in 6 (Basic) oder 4 (Take Two) unterschiedlichen Längen oder auf Maß. Hochvolttechnik, dimmbar. Optional mit Reflektor.

Available as mirror fitting lamp (mirror) wall mounting lamp (wall), mirror clip lamp (fix), in chrome or nickel matt. Available in 6 (Basic) or 4 (Take Two) different lengths or manufactured to size. High voltage technology, dimmable. Optionally with baffle.

## Basic

Modell model Basic ~2.700k	Halogen G9/QT14, <b>D</b> 20W Eco, ~235lm	Halogen G9/QT14, <b>D</b> 3 x 20W Eco, ~705lm	Halogen G9/QT14, <b>D</b> 4 x 20W Eco, ~940lm	Oberfläche surface
Lichtrohr innen weiß, außen satiniert. Ab 60 cm Lichtrohr nur außen satiniert. Lighting tube inside white, outside frosted. From 60 cm lighting tube frosted only on the outside.				
Länge (length)**	25 cm	40 cm	60 cm	
Basic wall	2-7251 2-7252	2-7401 2-7402	2-7601 2-7602	nickel matt chrome
Basic Fix	2-8251 2-8252	2-8401 2-8402	2-8601 2-8602	nickel matt chrome
Basic mirror Bohrloch ø 10 mm borehole ø 10 mm	2-9251 2-9252	2-9401 2-9402	2-9601 2-9602	nickel matt chrome

\*\*ohne Wandschild (mit Wandschild +2,4 cm), excluding wall shield (with wall shield +2,4cm)  
Achismaß = Länge -1,5 cm, dimensiones between axes = -1,5 cm

Modell model Basic ~2.700k	Halogen G9/QT14, <b>D</b> 5 x 20W Eco, ~1.175lm	Halogen G9/QT14, <b>D</b> 7 x 20W Eco, ~1.645lm	Halogen G9/QT14, <b>D</b> 8 x 20W Eco, ~1.880lm	Oberfläche surface
Lichtrohr innen weiß, außen satiniert. Ab 60 cm Lichtrohr nur außen satiniert. Lighting tube inside white, outside frosted. From 60 cm lighting tube frosted only on the outside.				
Länge (length)**	80 cm	100 cm	120 cm	
Basic wall	2-7801 2-7802	2-71001 2-71002	2-71201 2-71202	nickel matt chrome
Basic Fix	2-8801 2-8802	2-81001 2-81002	2-81201 2-81202	nickel matt chrome
Basic mirror Bohrloch ø 10 mm borehole ø 10 mm	2-9801 2-9802	2-91001 2-91002	2-91201 2-91202	nickel matt chrome

\*\*ohne Wandschild (mit Wandschild +4 cm), excluding wall shield (with wall shield +4cm)  
Achismaß = Länge -1,5 cm, dimensiones between axes = -1,5 cm

## Take Two

Modell model Take Two ~2.800k	Halogen G9/QT14, <b>D</b> 2 x 20W Eco, ~700lm	Halogen G9/QT14, <b>D</b> 4 x 20W Eco, ~1.400lm	Halogen G9/QT14, <b>D</b> 4 x 20W Eco, ~1.400lm	Halogen G9/QT14, <b>D</b> 6 x 20W Eco, ~2.100lm	Oberfläche surface
Lichtrohr innen weiß, außen satiniert. Ab 60 cm Lichtrohr nur außen satiniert. Lighting tube inside white, outside frosted. From 60 cm lighting tube frosted only on the outside.					
Länge (length)**	30 cm	40 cm	60 cm	80 cm	
Take Two wall	2-4301 2-4302	2-4401 2-4402	2-4601 2-4602	2-4801 2-4802	nickel matt chrome
Take Two Fix	2-5301 2-5302	2-5401 2-5402	2-5601 2-5602	2-5801 2-5802	nickel matt chrome
Take Two mirror Bohrloch ø 10 mm borehole ø 10 mm	2-6301 2-6302	2-6401 2-6402	2-6601 2-6602	2-6801 2-6802	nickel matt chrome

\*\*ohne Wandschild (mit Wandschild +2,4 cm), excluding wall shield (with wall shield +2,4cm)  
Achismaß = Länge -1,5 cm, dimensiones between axes = -1,5 cm

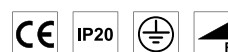
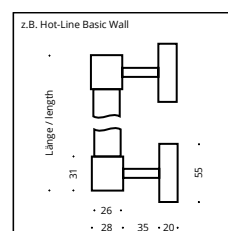

**Sondermaße** (special sizes):  
Lichtrohrverkürzung auf Maß  
Tube shortening to size

2-999

Lichtrohrverlängerung auf Maß ab 125 cm, für je 100 mm (aufgerundet)  
Tube extension to size

2-100

**Reflektor "Option"** für Basic,  
drehbar über Einstellstift  
**Baffle "option"** for Basic,  
rotatable by adjusting pin

9-211

**Reflektor "Option"** für Take Two,  
drehbar über Einstellstift, zweiteilig  
**Baffle "option"** for Take Two,  
rotatable by adjusting pin

9-212

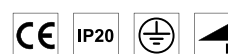
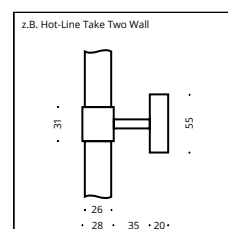



# HotLine - EasySystem

Diese Wand- und Deckenanbauleuchte in nickelmatt ist erhältlich in 80 cm, 160 cm oder 240 cm, Lichtrohrverkürzung auf Maß möglich, Hochvolttechnik, dimmbar, Optional mit Reflektor, auch in chrom lieferbar.

This wall or ceiling mounting lamp in nickel matt design is available in the following lengths: 80, 160 or 240 cm. Shortening to size possible. High voltage technology, dimmable, optionally with baffle. Also available in chrome finish.



HotLine - Easysystem



## EasySystem

Halogen G9/QT14, 	Maße* dimensiones*	Ausführung design	20W ECO
4-1801 ~1.410lm	80 cm	nickel matt	x 6
4-1802 ~1.410lm	80 cm	chrome	x 6
4-11601 ~2.350lm	160 cm	nickel matt	x 10
4-11602 ~2.350lm	160 cm	chrome	x 10
4-12401 ~3.290lm	240 cm	nickel matt	x 14
4-12402 ~3.290lm	240 cm	chrome	x 14

Nur außen satiniert. Frosted outside only.

Reflektor "Option" für Easysystem 80 cm, drehbar über Einstellstift, für jede weitere Länge zusätzlich mitbestellen: Art.-Nr. 9-233

Baffle "option" for Easy System, rotatable by adjusting pin, order separately for each additional length: Art.-Nr. 9-233

\*Gesamtlänge = Länge + 40 mm, total length = length + 40 mm

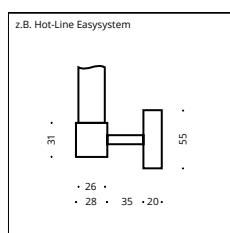



Lichtstange





# Lichtstange

Erhältlich als Wandleuchte, mit Linestra-Röhre 1-sockelig in opal, wahlweise auch mit Linestra-Röhre in klar, 60 Watt, optional mit Kippschalter, Wandabstand 70 mm. Als Lichtstange mit Klemmbefestigung zur Montage am Spiegel, mit transparentem Kabel, Schalter und Stecker, Leuchtmittel Linestra 1-sockelig opal, 60 Watt (optional 35 Watt).

Available as wall lamp, with Linestra tube with one base in opal or optionally with Linestra tube in clear, 60 watts. Optionally with dip switch, wall spacing 70 mm. As light bar with clip for mirror mounting, with transparent cable, switch and plug. Linestra lamp with one base, opal 60 watts (or 35 watts).



Gehäuse in schwarz und weiß  
body in black and white



Klemmi



Chrom, chrome



Chrommatt, chrome matt



Nickelmatt, nickel matt

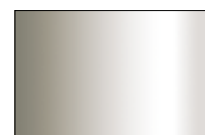

Nickelvelours, nickel suede

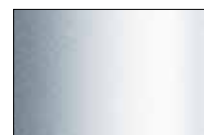

Alumattstruktur,  
alum. matt structure

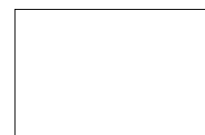

Weiß, white



Schwarz, black



Schalter und Kabel transp.  
Transp. switch and cable



Optional mit integriertem Schalter  
optionally with integrated switch

**Alternativ auch:**  
LED oder Leuchtstofflampen  
im Handel erhältlich.

**Alternative:**  
LED oder fluorescent lamps  
commercially available.

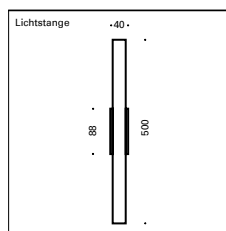

Modell model	Linestra, opal E 60W ~420lm, ~3.000k	Ausführung design
Lichtstange	2-0302	chrome
	2-0302-W	white
	2-0302-S	black
	2-0301	chrome matt
	2-0309	nickel matt
	2-0303	nickel suede
	2-0304	alum. matt texture
Lichtstange Klemmi Spiegelstärke mirror thickness 3-9 mm	2-0312	chrome
	2-0312-W	white
	2-0312-S	black
	2-0311	chrome matt
	2-0319	nickel matt
	2-0313	nickel suede
	2-0314	alum. matt texture

Für einen Schalter hängen Sie bitte ein -k hinter die Art.-Nr.  
Please attach -k behind the item-no. for a switch.

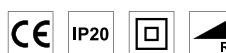





Two Socket Base



Two Socket



Two Socket Fix



Two Socket Base



Two Socket Base Fix



# Two Socket

... gerade richtig ... just right!



Two Socket chrome



Two Socket Base nickel matt

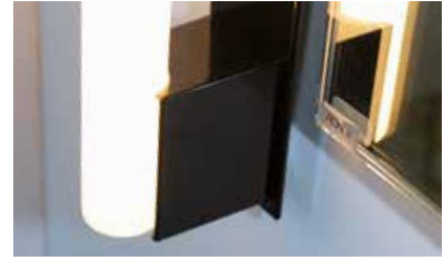

Two Socket Base black



Two Socket Fix chrome



Two Socket Base Fix nickel matt



Two Socket Base white

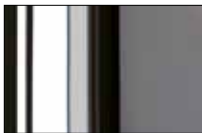

Chrom, chrome



Nickelmatt, nickel matt

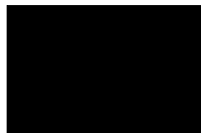

Schwarz, black



Weiß, white

**Alternativ auch:**  
LED oder Leuchtstofflampen  
im Handel erhältlich.

**Alternative:**  
LED oder fluorescent lamps  
commercially available.

Modell model	Linestra, opal/klar E max.120W ohne Leuchtmittel without lamp	Ausführung design	Beschreibung specification
Two Socket	2-0402 2-0402-W 2-0402-S 2-0409	chrome white black nickel matt	Wandleuchte für Linestra-Röhre, 2-sockelig, maximal 120 Watt Wall lamp for Linestra tube, 2 bases, max.120 watts
Two Socket Base	2-0422 2-0422-W 2-0422-S 2-0429	chrome white black nickel matt	Wandleuchte mit Grundplatte, für Linestra-Röhre, 2-sockelig, max. 120 Watt Wall lamp with base plate for Linestra tube, 2 bases, max.120 watts
Two Socket Fix Spiegelstärke mirror thickness 3-9 mm	2-0412 2-0412-W 2-0412-S 2-0419	chrome white black nickel matt	Two Socket mit Klemmbefestigung zur Montage am Spiegel, für Linestra-Röhre, 2-sockelig, max. 120 Watt Two Socket with clip mounting piece for mirror mounting for Linestra tube, 2 bases, max.120 watts
Two Socket Base Fix Spiegelstärke mirror thickness 3-9 mm	2-0432 2-0432-W 2-0432-S 2-0439	chrome white black nickel matt	Two Socket mit Grundplatte und Klemmbefestigung zur Montage am Spiegel, für Linestra-Röhre, 2-sockelig, max. 120 Watt Two Socket with clip mounting piece for mirror mounting for Linestra tube, 2 bases, max.120 watts

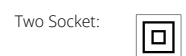
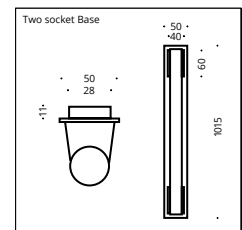

# Lens, Focus, Puk & Puk Maxx (Fix & Mirror)

Weitere Angaben zu der Lens finden Sie auf Seite 193, zu der Focus auf Seite 197-199, zu der Puk auf Seite 21-23 und zu der Puk Maxx auf Seite 67-69.

Further Information about the Lens you will find on page 183, about the Focus on page 197-199, about the Puk on page 21-23 and about the Puk Maxx on page 67-69.



Lens Mirror chrome



Puk Fix chrome



Focus 150 Fix chrome



Puk Maxx Mirror nickel matt



## Flexlight, Glasslight & Spotlight Fix

Weitere Angaben zu der Flexlight finden Sie auf Seite 240, die Informationen zu der Glasslight auf Seite 248 und zu der Spotlight auf Seite 251.

Further information about the Flexlight you will find on page 240, the facts about the Glasslight you will find on page 248, Spotlight on page 251.



Spotlight Fix Ariane chrome



Flexlight Fix India chrome



Glass Light Fix Pisa Double nickel matt







# Spiegelanwendungen

## Mirror Applications



	Modell model	Art.Nr. item no.
1	Puk Fix Seite 21	2-08011
2	Better Fix Seite 177	2-0741
3	Klemmi Seite 183	2-0311
4	Pisa Double Seite 249	2-200230
5	Focus Fix Seite 199	2-101572 2-1202
6	Lens Fix Seite 193	2-10123
7	Tube Wall Seite 207	2-08652
8	Puk Wall »+« Seite 19	2-0801





# Wohnraum-, Bad & Objektleuchten für die Wand

Living Room, Bath & Object Lamps for the Wall

## Puk World



Puk Leuchten für die Wand ab Seite 17  
Puk lamps for wall mounting on page 17 and following

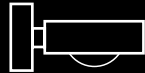

Lens Wall 193

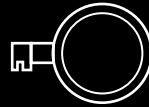

Lens Fix 193

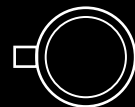

Lens Mirror 193  
Lens Equipment 195



Focus 100 197

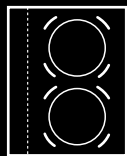

Focus 150 199

Focus Equipment 201



Lightboard  
Sushi & Tokyo 203

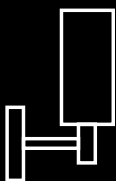

Cube One 205

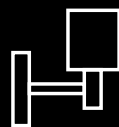

Cube One  
Short 205

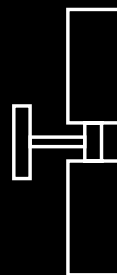

Cube Twin 205

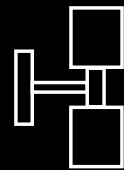

Cube Twin  
Short 205

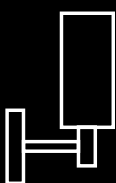

Tube One 207

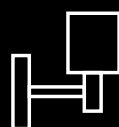

Tube One  
Short 207

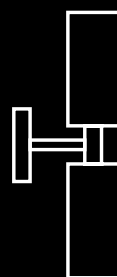

Tube Twin 207

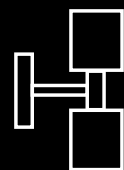

Tube Twin  
Short 207





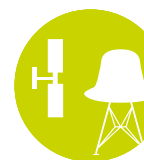

# Lens Wall Fix & Mirror

Wandleuchte, Spiegelklemm- oder Spiegeleinbauleuchte aus chrom, chrommatt oder nickelmatt.

Wall lamp, mirror-clip or mirror mounting lamp in chrome, chrome matt or nickel matt.



Modell model	Länge ab Wand length from wall	Halogen G9/QT14: <b>D</b> 1 x 48W ECO ~740lm ~2.800k	Gehäuse body
Lens Wall	150 mm 150 mm 150 mm 150 mm 150 mm	2-10111 2-10112 2-10113 2-10114 2-10115	nickel matt chrome chrome matt chrome/white chrome/black

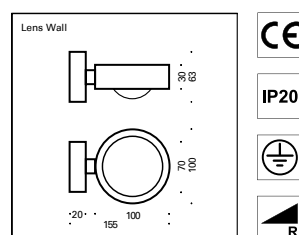

Modell model	Länge ab Spiegel length from mirror	Halogen G9/QT14: <b>D</b> 1 x 48W ECO ~740lm ~2.800k	Gehäuse body
Lens Fix	140 mm 140 mm 140 mm 140 mm 140 mm	2-10121 2-10122 2-10123 2-10124 2-10125	nickel matt chrome chrome matt chrome/white chrome/black

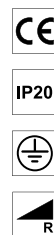
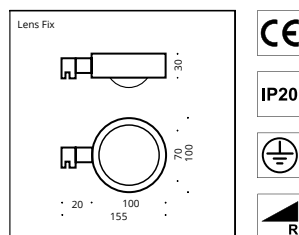

Modell model	Länge ab Spiegel length from mirror Spiegelbohrloch ø 10 mm Mirror borehole ø 10 mm	Halogen G9/QT14: <b>D</b> 1 x 48W ECO ~740lm ~2.800k	Gehäuse body
Lens Mirror	130 mm 130 mm 130 mm 130 mm 130 mm	2-10131 2-10132 2-10133 2-10134 2-10135	nickel matt chrome chrome matt chrome/white chrome/black

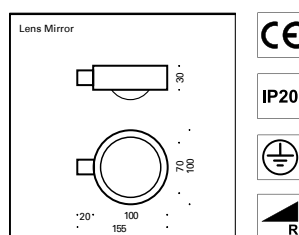

Bei den Lens Leuchten werden zu dem Leuchtenkopf die Gläser/Linsen und die Farbfilter separat dazubestellt! Artikelnummern entnehmen Sie bitte der Tabelle auf Seite 195.

With the Lens lamps, the glasses, lenses and color filters are ordered separately. Please check the list on page 195 for item numbers.





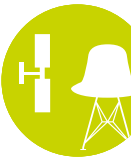

# Lens

Diese Leuchte ist individuell als Wandleuchte, Spiegelklemm- oder Spiegeleinbauleuchte einsetzbar. Es gibt eine Vielzahl an Möglichkeiten der Gestaltung des drehbaren Leuchtkopfes.

This lamp is deployable individually as wall lamp, mirror-clip or mirror mounting lamp. There are numerous possibilities to configure the rotatable lamp head.



Lens in weiß, Lens in white

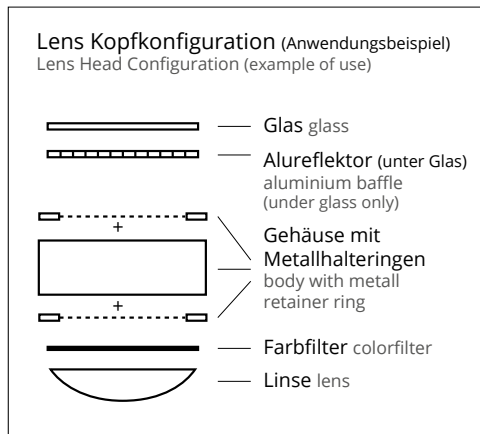

Lens in schwarz, Lens in black

Gläser, Linsen und Farbfilter einzeln dazubestellen:  
 Order glasses, lenses color filter separately:

Art. Nr. item no.	Linse klar lens clear	Glas beids. mattiert glass, frosted both-sided	Alurefektor nur unter Glas aluminium baffle, only in combination with glass
2-20xx	26	27	25

Art.Nr. item no.	Farbfilter rot color filter red	Farbfilter magenta color filter magenta	Farbfilter gelb color filter yellow	Farbfilter blau color filter blue	Farbfilter grün color filter green
2-20xx	28	29	30	33	34







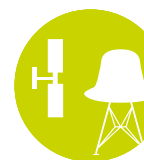

# Focus 100

100 mm breite Wandleuchte in chrom oder nickelmatt, wahlweise in LED- oder Hochvolt Halogen Ausführung, alle dimmbar.

100 mm wide wall lamp in chrome or nickel matt, available in LED or high voltage halogen design, all dimmable.

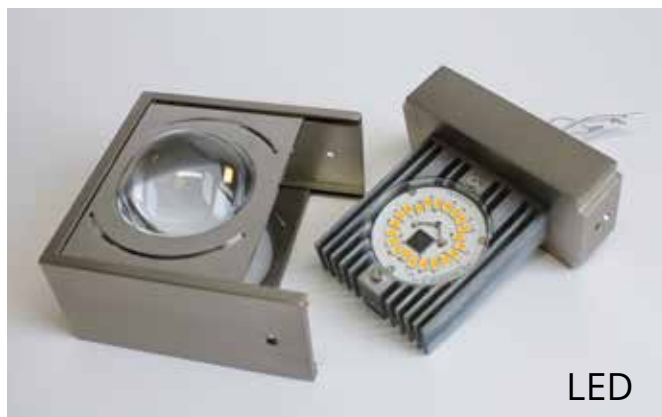

LED

Focus 100 LED



Focus 100 chrome



Focus 100 nickel matt



Focus 100 nickel matt

## LED

LED: **A+**  
2 x 8W  
~1.200lm ~2.800k

2-101001-LED  
2-101002-LED

## Halogen

G9/QT14: **D**  
1 x 60W ECO  
~980lm ~2.800k

2-101001  
2-101002

## Gehäuse body

nickel matt  
chrome

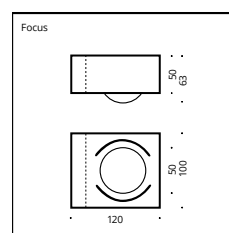

LED:



Halogen:



Bei den Focus Leuchten werden zu dem Leuchtenkopf die Gläser, die Linsen und die Farbfilter separat dazubestellt! Artikelnummern entnehmen Sie bitte der Zubehör-Tabelle auf Seite 201.

With the Focus lamps, the glasses, the lenses and the color filters are ordered separately. Please check the list on page 201 for item numbers.



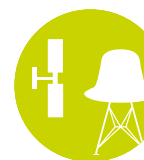

# Focus 150

150 mm breite Wandleuchte in chrom oder nickelmatt, wahlweise in LED- oder Hochvolt Halogen Ausführung, alle dimmbar.

150 mm wide wall lamp in chrome or nickel matt, available in LED or high voltage halogen design, all dimmable.



2 x 40W (Halogen) oder/or 4 x 4W (LED)



1 x 60W (Halogen) oder/or 2 x 8W (LED)



2 x 40W (Halogen) oder/or 3 x 33W (Halogen) oder/or 4 x 4W (LED)



2 x 40W (Halogen) oder/or 3 x 33W (Halogen) oder/or 4 x 4W (LED)

## LED

LED: **A+**  
~2.800k

2-101501-LED 2 x 8W ~1.200lm  
2-101502-LED 2 x 8W ~1.200lm

2-101503-LED 4 x 4W ~1.200lm  
2-101504-LED 4 x 4W ~1.200lm

## Halogen

G9/QT14: **D**  
~2.800k

2-101501 1 x 60W ECO ~980lm  
2-101502 1 x 60W ECO ~980lm

2-101503 2 x 40W ECO ~700lm  
2-101504 2 x 40W ECO ~700lm

2-101505 3 x 33W ECO ~1.400lm  
2-101506 3 x 33W ECO ~1.400lm

## Gehäuse body

nickel matt  
chrome

nickel matt  
chrome

nickel matt  
chrome

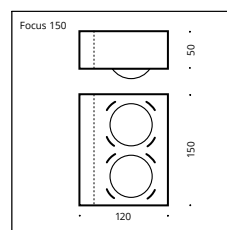

LED:



Halogen:



Bei den Focus Leuchten werden zu dem Leuchtenkopf die Gläser, die Linsen und die Farbfilter separat dazubestellt! Artikelnummern entnehmen Sie bitte der Zubehör-Tabelle auf Seite 201.

With the Focus lamps, the glasses, the lenses and the color filters are ordered separately. Please check the list on page 201 for item numbers.





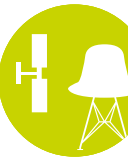

# Focus Equipment

Linsen, Gläser, Farbfilter und Spiegelhalter frei zu kombinieren.

Lenses, glasses, color filters and spring mounting at the mirror for separate order.



Art. Nr. item no.	Einsatz insert	Beschreibung description
2-626	Linse, lens	klar, clear
2-626-s	Linse, lens	einseitig mattiert, frosted on one side
2-627	Glas, glass	beidseitig mattiert, passt nicht unter Linse frosted on both sides, doesn't fit under lens
2-628	Farbfilter, color filter	rot, red
2-629		magenta, magenta
2-630		gelb, yellow
2-633		blau, blue
2-634		grün, green
2-1201	Spiegelhalter	Klemmmontage am Spiegel, Spring mounting on mirror

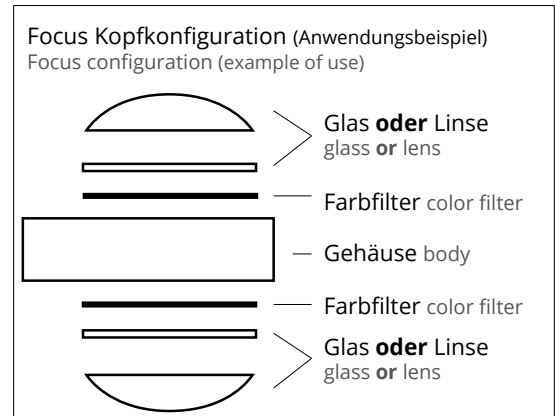

rot, red



magenta, magenta



gelb, yellow



blau, blue

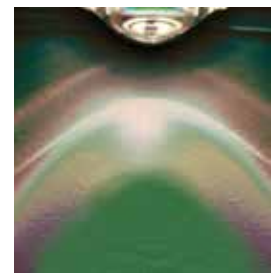

grün, green



Lightboard Sushi



Lightboard Tokyo

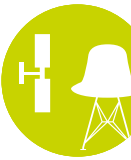

# Lightboard

Wandregal beleuchtet, Leuchtstoff, wahlweise in Edelstahl-Optik oder Aluminium eloxiert, Sicherheitsglas (ESG), auf Gummidichtung.

Illuminated rack, flourescent lamp, alternatively in stainless steel design or anodised aluminium, safety glass (ESG) on rubber gasket.

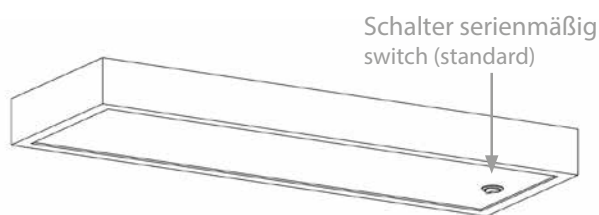

T5 Leuchtstofflampe: A ~3.000k	Art.Nr. item no.	Oberfläche surface	L x B x H l x w x h
Sushi Mini 1 x 8W ~470lm, < 10 kg	2-45203201	Alueloxiert, Anodised aluminium	450 x 200 x 33 mm
	2-45203209	Edelstahl-Optik, Stainless steel design	450 x 200 x 33 mm
Sushi Midi 1 x 14W ~1.200lm, < 10 kg	2-60203201	Alueloxiert, Anodised aluminium	600 x 200 x 33 mm
	2-60203209	Edelstahl-Optik, Stainless steel design	600 x 200 x 33 mm
Sushi Maxi 1 x 21W ~2.100lm, < 10 kg	2-90203201	Alueloxiert, Anodised aluminium	900 x 200 x 33 mm
	2-90203209	Edelstahl-Optik, Stainless steel design	900 x 200 x 33 mm
Sushi Gigant 1 x 28W ~2.900lm, < 10 kg	2-120203201	Alueloxiert, Anodised aluminium	1200 x 200 x 33 mm
	2-120203209	Edelstahl-Optik, Stainless steel design	1200 x 200 x 33 mm

T5 Leuchtstofflampe: A ~3.000k	Art.Nr. item no.	Oberfläche surface	L x B x H l x w x h
Tokyo Mini 1 x 8W ~470lm, < 20 kg	2-45205201	Alueloxiert, Anodised aluminium	450 x 200 x 52 mm
	2-45205209	Edelstahl-Optik, Stainless steel design	450 x 200 x 52 mm
Tokyo Midi 1 x 14W ~1.200lm, < 20 kg	2-60205201	Alueloxiert, Anodised aluminium	600 x 200 x 52 mm
	2-60205209	Edelstahl-Optik, Stainless steel design	600 x 200 x 52 mm
Tokyo Maxi 1 x 21W ~2.100lm, < 20 kg	2-90205201	Alueloxiert, Anodised aluminium	900 x 200 x 52 mm
	2-90205209	Edelstahl-Optik, Stainless steel design	900 x 200 x 52 mm
Tokyo Gigant 1 x 28W ~2.900lm, < 20 kg	2-120205201	Alueloxiert, Anodised aluminium	1200 x 200 x 52 mm
	2-120205209	Edelstahl-Optik, Stainless steel design	1200 x 200 x 52 mm

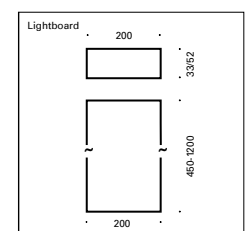





Cube Twin

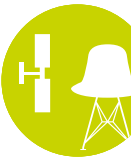

# Cube

Wandleuchte, Opalglas, chrom oder nickelmatt Aufbau.  
Wall lamp, opal glass, chrome or nickel matt design. Surface mounting.



Halogen E27: <b>C</b> ~2.900k	Art.Nr. item no.	Dulux Stecksocket G24 Q-1: <b>A</b> 10W, ~600lm, ~3.000k	Art.Nr. item no.	Oberfläche surface
<b>Cube-One**</b> 1 x 100W, ~1.800lm	2-18621 2-18622	Cube-One PL	2-19621-PL 2-19622-PL	nickel matt chrome
<b>Cube-Twin**</b> 2 x 70W, ~1.180lm	2-08621 2-08622	Cube-Twin PL	2-09621-PL 2-09622-PL	nickel matt chrome

\*\*E14 auf Anfrage/Empfehlung Adapter E27 → E14  
\*\*E14 on request/recommendation adapter E27 → E14

Halogen G9/QT14: <b>D</b> ~2.800k	Art.Nr. item no.	Oberfläche surface
<b>Cube-One-short</b> 1 x 60W ECO, ~980lm	2-16621 2-16622	nickel matt chrome
<b>Cube-Twin-short</b> 2 x 60W ECO, ~980lm	2-06621 2-06622	nickel matt chrome

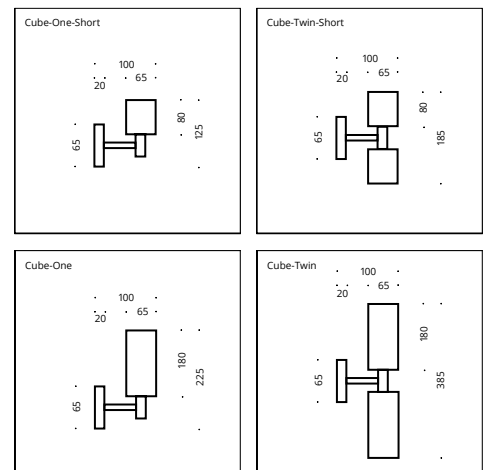



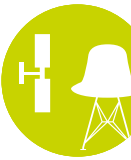

# Tube

Wandleuchte, Mattglas, innen weiß lackiert, chrom oder nickelmatt Aufbau.

Wall lamp, frosted glass, white coated interior, chrome or nickel matt design. Surface mounting.



**Reflektor "Option":**  
Aluminium-Hochleistungsreflektor, einfache Montage durch Einschub in den Glastubus.

**Baffle "option":**  
Trend-setting: High performance baffle. Easy installation: slides into the tube.



Halogen E27: <b>C</b> ~2.900k	Art.Nr. item no.	Dulux Stecksockel G24 Q-1: <b>A</b> 10W, ~600lm, ~3.000k	Art.Nr. item no.	Oberfläche surface
<b>Tube-One**</b> 1 x 100W, ~1.800lm	2-18651 2-18652	<b>Tube-One PL</b>	2-19651-PL 2-19652-PL	nickel matt chrome
<b>Tube-Twin**</b> 2 x 70W, ~1.180lm	2-08651 2-08652	<b>Tube-Twin PL</b>	2-09651-PL 2-09652-PL	nickel matt chrome

\*\*E14 auf Anfrage/Empfehlung Adapter E27 → E14

\*\*E14 on request/recommendation adapter E27 → E14

Halogen G9/QT14: <b>D</b> ~2.800k	Art.Nr. item no.	Oberfläche surface
<b>Tube-One-short</b> 1 x 60W ECO, ~980lm	2-16651 2-16652	nickel matt chrome
<b>Tube-Twin-short</b> 2 x 60W ECO, ~980lm	2-06651 2-06652	nickel matt chrome
<b>"Option"</b>	9-200	Reflektor für Tube baffle for tube
<b>"Option"</b>	9-201	Reflektor für Tube-short baffle for tube-short

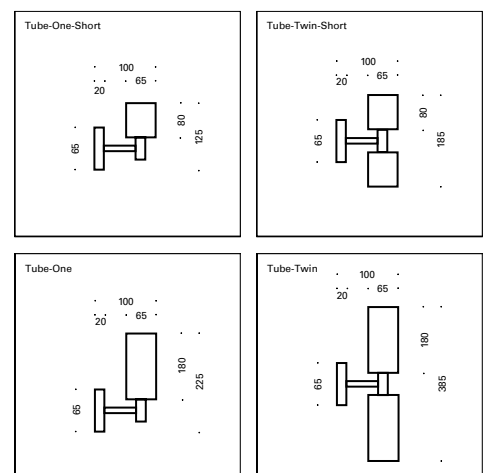

Halogen:







# Wohnraum-, Bad- & Objekteuchten für die Decke

Living Room, Bath & Object Lamps for the Ceiling

## Puk World

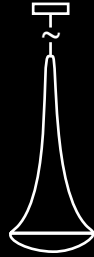
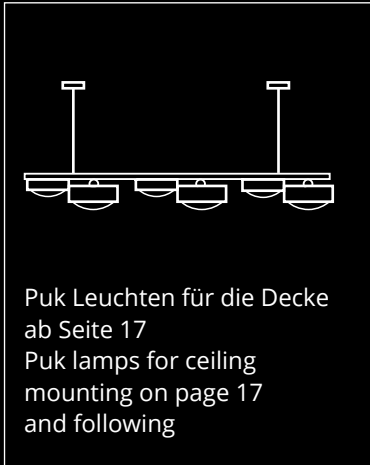

Look at me 210-213

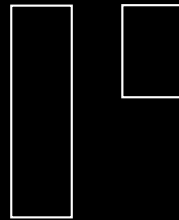

Dela 217  
Dela Short  
Dela Short Spot

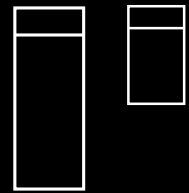

Dela Box 218  
Dela Box Short  
Dela Box Short Spot

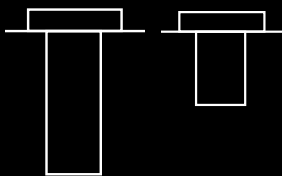

Ceiling Dela 219  
Ceiling Dela Short  
Ceiling Dela Short Spot

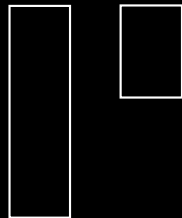

Quadro 220  
Quadro Short  
Quadro Short Spot



Quadro Box 221  
Quadro Box Short  
Quadro Box Short Spot

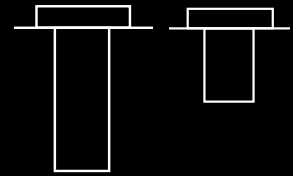

Ceiling Quadro 222  
Ceiling Quadro Short  
Ceiling Quadro Short Spot

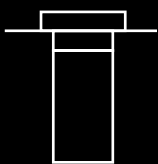

Ceiling Pisa 223

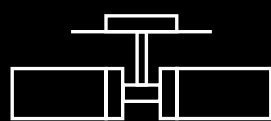

Ceiling Pisa  
Double 223

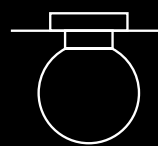

Ceiling Bulb 223



Pela 225  
Pela Quadro





# Look at me

LED-Pendelleuchte mit 8 Watt und ~600 Lumen. Kabellänge ca. 1,20 m. EU Verordnung 874/2012, enthält eingebaute LED Leuchtmittel der Energieklasse A.

LED pendula lamp with 8 watts and ~600 lumen. Length of the cable 1,20 m. EU Regulation 874/2012, contains built-in LED lamps of energy class A.



Look at me white



Look at me chrome

LED	LED IP44	Höhe mit Linse	Durchmesser	Gehäuse
LED: <b>A+</b>	LED: <b>A+</b>	height with lens	diameter	body
8W ~600lm ~2.800k	8W ~600lm ~2.800k			
5-911-1	5-911-1-IP	215 mm	85 mm	chrommatt
5-911-2	5-911-2-IP	215 mm	85 mm	chrome
5-911-3	5-911-3-IP	215 mm	85 mm	white
5-911-5	5-911-5-IP	215 mm	85 mm	black

Art. Nr. item no.	Einsatz insert	Beschreibung description
2-9126 2-9126-S	Linse lens	klar, clear einseitig mattiert, satinated on one side
2-9128 2-9129 2-9130 2-9133 2-9134	Farbfilter color filter	rot, red magenta, magenta gelb, yellow blau, blue grün, green

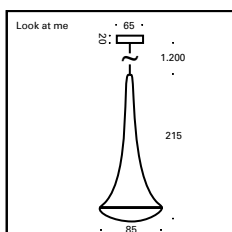







# Look at me



Look at me chrome



Look at me chrome matt



Look at me black



Look at me white







## Dela & Pela









# Dela

Deckenleuchten, Mattglas, innen weiß, inkl. Halogenleuchtmittel.  
Ceiling lamp, frosted glass, white interior, including halogen lamp.

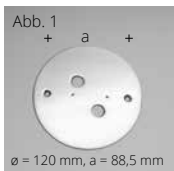

Abdeckplatte, passend für Dela und Dela-short/Spot, Sicht- und Hitzeschutz für Holzdecken und Hohlraumdosens, superflach - nur 2 mm, seitliche (Abb. 1) oder verdeckte Montage (Abb. 2).

Cover panel for Dela and Dela-short/Spot. Screen and heat protection for wooden ceilings and cavity outlets. Super flat - only 2 mm. For lateral (Abb. 1) or hidden (Abb. 2) mounting.



Reflektor "Option", baffle "option"



Richtungsweisend:

Aluminium-Hochleistungsreflektor, einfache Montage durch Einschub in den Glastubus.

Multi directional:

High performance baffle. Easy installation: slides into the tube.



Dela



Dela Short



Dela Short Spot mit Abdeckplatte/with cover panel

Halogen	Art.Nr. item no.	B x H w x h in mm	Ausführung design
E27: <b>C</b> ~2.900k 80W, ~1.800lm			
Dela	4-07651	65 x 180	satiniertes Glas frosted glass

Halogen	Art.Nr. item no.	B x H w x h in mm	Ausführung design
<b>D</b> ~2.700k			
Dela Short G9: 60W ECO, ~980lm	4-06650	65 x 80	satiniertes Glas frosted glass
Dela Short Spot GU 10:35W, ~230lm	7-06659	65 x 80	Deckenstrahler ceiling spotlight

Modell model	Art.Nr. item no.	Ausführung design
"Option"	9-200	Reflektor für Dela baffle for Dela
"Option"	9-201	Reflektor für Dela Short baffle for Dela Short
Abdeckplatte, seitliche Montage lateral cover panel	9-12012 9-12019	chrome nickel matt
Abdeckplatte, verdeckte Montage hidden cover panel	9-12002 9-12009	chrome nickel matt

PL Leuchtstofflampe:	Art.Nr. item no.	B x H w x h in mm	Ausführung design
<b>A</b> ~2.900k			
Dela Dulux Stecks. G24 Q-1:10W, ~600lm	4-07651-PL	65 x 180	satiniertes Glas frosted glass
Dela Short PL G9: 7W, ~380lm	4-06650-PL	65 x 80	Deckenstrahler ceiling spotlight
Dela Short Spot PL GU 10: 7W, ~380lm	7-06659-PL	65 x 80	mit Stecksockel with plug base

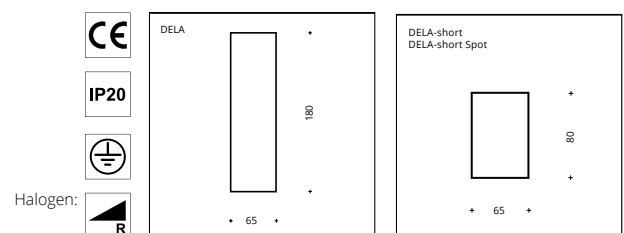

# Dela Box

Deckenleuchten, Mattglas, innen weiß, Aufbausockel wahlweise in chrom oder nickelmatt, inkl. Halogenleuchtmittel.

Ceiling lamps, frosted glass, white interior, mounting base alternatively in chrome or nickel matt design, including halogen lamp.



Dela Box Short Spot



Reflektor "Option"  
baffle "option"

Richtungsweisend:  
Aluminium-Hochleistungsreflektor, einfache Montage durch Einschub in den Glastubus.

Multi directional:  
High performance baffle.  
Easy installation: slides into the tube.



Dela Box Short & Box

Halogen	Art.Nr. item no.	Ausführung design
E27: <b>C</b> ~2.900k 80W, ~1.800lm		
Dela Box	4-04651	nickel matt
"Option"	4-04652 9-200	chrome Reflektor, baffle
Halogen	Art.Nr. item no.	Ausführung design
<b>D</b> ~2.700k		
Dela Box Short G9: 60W ECO, ~980lm "Option"	4-05651 4-05652 9-201	nickel matt chrome Reflektor, baffle
Dela Box Short Spot GU 10: 35W, ~230lm	4-05658 4-05659	nickel matt chrome

PL Leuchtstofflampe:	Art.Nr. item no.	Ausführung design
<b>A</b> ~2.900k		
Dela Box PL G24 Q-1: 10W, ~600lm	4-04651-PL 4-04652-PL	nickel matt chrome
Dela Box Short PL G9: 7W, ~380lm	4-05651-PL 4-05652-PL	nickel matt chrome
Dela Box Short Spot PL GU 10: 7W, ~380lm	4-05658-PL 4-05659-PL	nickel matt chrome
LED LED: <b>A+</b>	Art.Nr. item no.	Ausführung design
4W, ~390lm, ~3.000k		
Dela Box LED	4-04651-LED 4-04652-LED	nickel matt chrome
Dela Box Short LED	4-05651-LED 4-05652-LED	nickel matt chrome

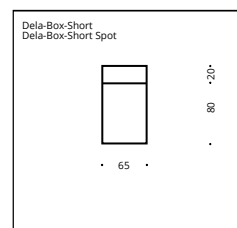
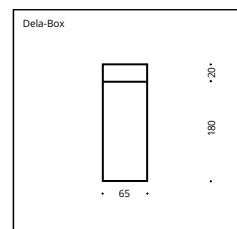

Halogen:



LED:





# Ceiling Dela

Halogendeckenleuchte, Mattglas, innen weiß lackiert, in chrom oder nickelmatt gebürstet.

Halogen lamp, frosted glass, white coated interior, in chrome or nickel matt brushed design.



Ceiling Dela, Short & Short Spot



Ceiling Dela

Optional mit Reflektor. s. Seite links.  
Optionally with baffle see left page.

Halogen E27: <b>C</b> ~2.900k	Art.Nr. item no.	Ausführung design
Ceiling Dela 80W, ~1.800lm "Option"	4-08652 4-08659 9-200	chrome nickel matt Reflektor, baffle
Halogen <b>D</b> ~2.700k	Art.Nr. item no.	Ausführung design
Ceiling Dela Short G9: 60W ECO, ~980lm "Option"	4-09652 4-09659 9-201	chrome nickel matt Reflektor, baffle
Ceiling Dela Short Spot GU 10: 35W, ~230lm	7-07652 7-07659	chrome nickel matt

PL Leuchtstofflampe: <b>A</b> ~2.900k	Art.Nr. item no.	Ausführung design
Ceiling Dela PL G24 Q-1:10W, ~600lm	4-08652-PL 4-08659-PL	chrome nickel matt
Ceiling Dela Short PL G9: 7W, ~380lm	4-09652-PL 4-09659-PL	chrome nickel matt
Ceiling Dela Short Spot PL GU 10: 7W, ~380lm	7-07652-PL 7-07659-PL	chrome nickel matt

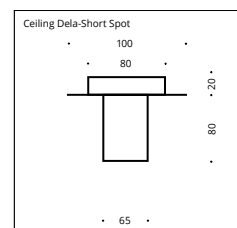
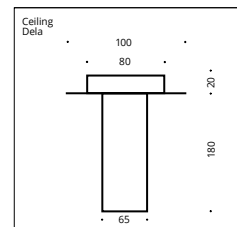

Halogen:



LED:





# Quadro

Deckenleuchte, Opalglas, inkl. Halogenleuchtmittel.  
Ceiling light, opal glass, including lamp.



Quadro Short Spot



Halogen:

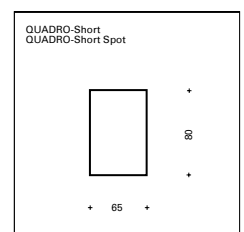
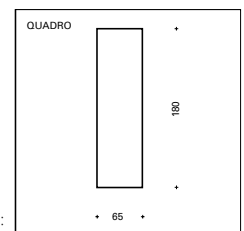

Quadro Short & Quadro

Halogen E27: <b>C</b> ~2.900k	Art.Nr. item no.	Ausführung design
Quadro 80W, ~1.800lm	4-07621	satiniertes Glas, frosted glass
Halogen <b>D</b> ~2.700k	Art.Nr. item no.	Ausführung design
Quadro Short G9: 60W ECO, ~980lm	4-06620	satiniertes Glas, frosted glass
Quadro Short Spot GU 10: 35W, ~230lm	7-06629	satiniertes Glas, frosted glass

PL Leuchtstofflampe: <b>A</b> ~2.900k	Art.Nr. item no.	Ausführung design
Quadro PL G24 Q-1:10W, ~600lm	4-07621-PL	satiniertes Glas, frosted glass
Quadro Short PL G9: 7W, ~380lm	4-06620-PL	satiniertes Glas, frosted glass
Quadro Short Spot PL GU 10: 7W, ~380lm	7-06629-PL	satiniertes Glas, frosted glass



# Quadro Box

Deckenleuchte, Opalglas, Aufbausockel wahlweise in chrom oder nickelmatt, inkl. Halogenleuchtmittel.

Ceiling lamps, opal glass, surface mounting base, in nickel matt or chrome design alternatively, including halogen lamp.



Quadro Box Short Spot



Quadro Box & Quadro Box Short

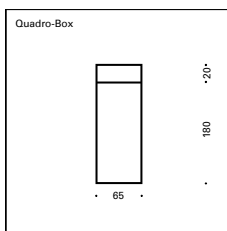

IP20

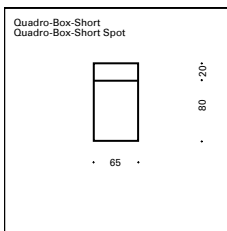

Halogen:



LED:



Halogen E27: <b>C</b> ~2.900k	Art.Nr. item no.	Ausführung design
Quadro Box 80W, ~1.800lm	4-04621 4-04622	nickel matt chrome
Halogen <b>D</b> ~2.700k	Art.Nr. item no.	Ausführung design
Quadro Box Short G9: 60W ECO, ~980lm	4-05621 4-05622	nickel matt chrome
Quadro Box Short Spot GU 10: 35W, ~230lm	4-05628 4-05629	nickel matt chrome

PL Leuchtstofflampe: <b>A</b> ~2.900k	Art.Nr. item no.	Ausführung design
Quadro Box PL G24 Q-1:10W, ~600lm	4-04621-PL 4-04622-PL	nickel matt chrome
Quadro Box Short PL G9: 7W, ~380lm	4-05621-PL 4-05622-PL	nickel matt chrome
Quadro Box Short Spot PL GU 10: 7W, ~380lm	4-05628-PL 4-05629-PL	nickel matt chrome

LED LED: <b>A+</b> ~2.800k	Art.Nr. item no.	Ausführung design
Quadro Box LED 4W, ~390lm ~2.800k	4-04621-LED 4-04622-LED	nickel matt chrome
Quadro Box Short LED	4-05621-LED 4-05622-LED	nickel matt chrome

# Ceiling Qaudro

Wand- bzw. Deckenleuchte, Opalglas, inkl. Halogenleuchtmittel.  
Wall or ceiling lights, opal glass, including halogen lamp.



Ceiling Quadro

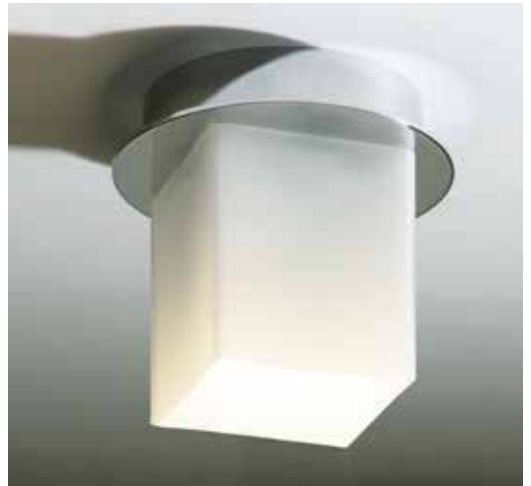

Ceiling Quadro Short



Ceiling Quadro Short Spot

Halogen E27: <b>C</b> → ~2.900k	Art.Nr. item no.	Ausführung design
Ceiling Quadro 80W, ~1.800lm	4-08621 4-08622	nickel matt chrome
Halogen <b>D</b> → ~2.700k	Art.Nr. item no.	Ausführung design
Ceiling Quadro Short G9: 60W ECO, ~980lm	4-09621 4-09622	nickel matt chrome
Ceiling Quadro Short Spot GU 10: 35W, ~230lm	7-09651 7-09652	nickel matt chrome

PL Leuchtstofflampe: <b>A</b> → ~2.900k	Art.Nr. item no.	Ausführung design
Ceiling Quadro PL G24 Q-1:10W, ~600lm	4-08621-PL 4-08622-PL	nickel matt chrome
Ceiling Quadro Short PL G9: 7W, ~380lm	4-09621-PL 4-09622-PL	nickel matt chrome
Ceiling Quadro Short Spot PL GU 10: 7W, ~380lm	7-09651-PL 7-09652-PI	nickel matt chrome

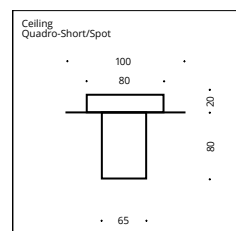
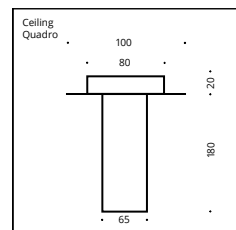

Halogen:





# Ceiling

Aufbauleuchte, Opalglas,  
inkl. Leuchtmittel

Surface mounting lamp,  
opal glass, incl. light.



Ceiling Bulb



Ceiling Pisadouble



Ceiling Bulb, Pisadouble & Pisa



Chrom, chrome



Nickelmatt, nickel matt

**Richtungsweisend:** Aluminium-Hochleistungsreflektor, einfache Montage durch Einschub in den Glastubus.

**Multi directional:** High performance baffle. Easy installation: slides into the tube.



Reflektor "Option"  
Baffle "option"

Halogen	Art.Nr.	Ausführung
G9/QT14:  ~2.700k	item no.	design
Ceiling Pisa 33W ECO, ~345lm	4-03855 4-03866	chrome nickelmatt
Ceiling Bulb 60W ECO, ~980lm	4-4280 4-4380	chrome nickelmatt
Ceiling Pisadouble 2 x 33W ECO, ~690lm	4-1415 4-1515	chrome nickelmatt
"Option"	9-204	Reflektor für Pisa baffle for Pisa

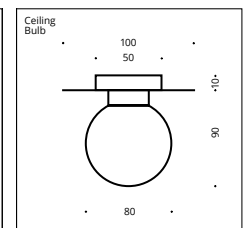
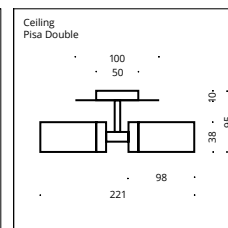
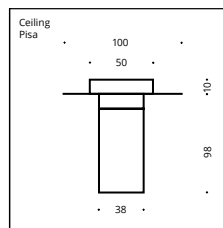

Halogen:









# Pela

Pendelleuchten, Standardkabellänge 1,10 m - 1,20 m zuzüglich Glas und Baldachin.

Pendulum lamp, standard cable length 1,10 m - 1,20 m, glass and baldachin extra.



Baldachin für Rundglas, nickelmatt & chrom.  
Baldachin for round glass nickel matt & chrome design.

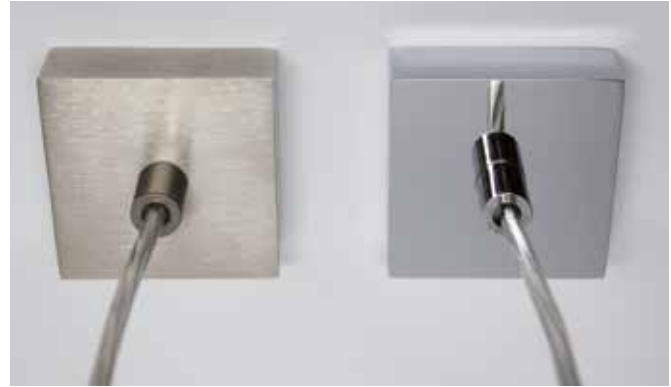

Baldachin für Quadroglas, nickelmatt & chrom.  
Baldachin for Quadroglas, nickel matt & chrome design.



**Richtungsweisend:**  
Aluminium-Hochleistungsreflektor, einfache Montage durch Einschub in den Glastubus.

**Multi directional:**  
High performance baffle. Easy installation: slides into the tube.

Halogen	Art.Nr. item no.	Oberfläche surface
E27: <b>C</b> ~2.900k 80W, ~1.800lm		
Pela	5-07651	nickel matt
"Option"	5-07652	chrome
Pela-Quadro	5-08651	nickel matt
	5-08652	chrome



Verbesserte Glashalteplatte  
Optimized glass holder

PL Leuchtstofflampe:	Art.Nr. item no.	Oberfläche surface
<b>A</b> ~2.900k G24 Q-1:10W, ~600lm		
Pela PL	5-07651-PL	nickel matt
	5-07652-PL	chrome
Pela-Quadro PL	5-08651-PL	nickel matt
	5-08652-PL	chrome
Kabelverlängerung Cable extension	5-07951	auf Maß, customized

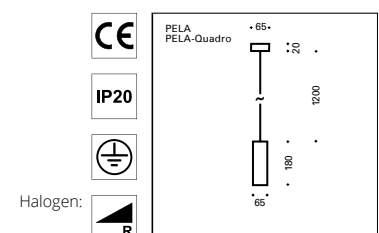



Fix  
Spring  
Plug  
Screw  
Wall  
Double Wall  
Table ....

# Baukastenleuchten

## Modular Lamps

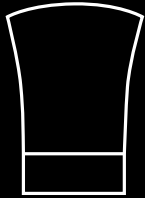

Ambiente 228 - 231

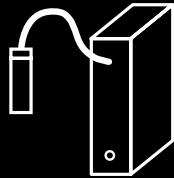

Light On 232 - 235

Flexlight 237

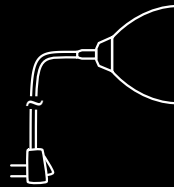

Flexlight Plug 239

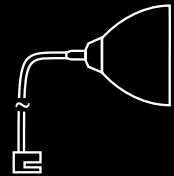

Flexlight Fix 240

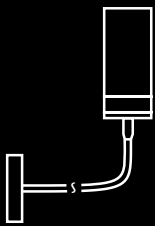

Flexlight Wall 241

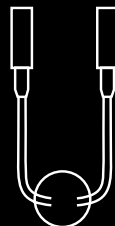

Flexlight Double Wall 242

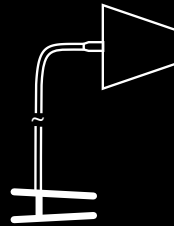

Flexlight Spring 243

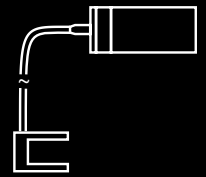

Flexlight Screw 244

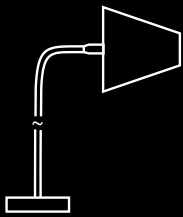

Flexlight Table 245

Puk World

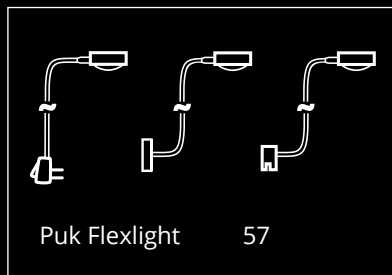

Puk Flexlight 57

Spotlight & Glaslight 247

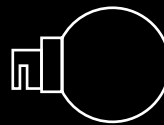

Glaslight Fix 248

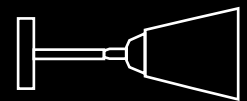

Glaslight Wall 249

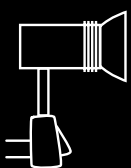

Spotlight Plug 250

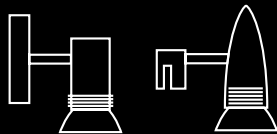

Spotlight Wall & Fix 251



Glaslight & Spotlight Screw 252

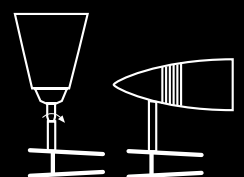

Glaslight & Spotlight Spring 253







# Ambiente danlight®

Die kabellose LED Tischleuchte Ambiente ist die Neuinterpretation des Windlichtes – stimmungsvolles Licht gepaart mit moderner Technologie.

The cordless LED table lamp Ambiente is the reinterpretation of the wind light – mood lighting combined with modern technology.



**Cone**

inkl. Glas + Basis  
incl. glass + base  
Art. Nr. 6-1001

nur Glas  
only glass  
Art. Nr. 6-1031



**Squeeze**

inkl. Glas + Basis  
incl. glass + base  
Art. Nr. 6-1006

nur Glas  
only glass  
Art. Nr. 6-1036



**Astral**

inkl. Glas + Basis  
incl. glass + base  
Art. Nr. 6-1002

nur Glas  
only glass  
Art. Nr. 6-1032



**Flower**

inkl. Glas + Basis  
incl. glass + base  
Art. Nr. 6-1007

nur Glas  
only glass  
Art. Nr. 6-1037



**Small Block**

inkl. Glas + Basis  
incl. glass + base  
Art. Nr. 6-1003

nur Glas  
only glass  
Art. Nr. 6-1033



**Big Block**

inkl. Glas + Basis  
incl. glass + base  
Art. Nr. 6-1008

nur Glas  
only glass  
Art. Nr. 6-1038



**Small Column**

inkl. Glas + Basis  
incl. glass + base  
Art. Nr. 6-1004

nur Glas  
only glass  
Art. Nr. 6-1034



**Big Column**

inkl. Glas + Basis  
incl. glass + base  
Art. Nr. 6-1009

nur Glas  
only glass  
Art. Nr. 6-1039



**Balloon**

inkl. Glas + Basis  
incl. glass + base  
Art. Nr. 6-1005

nur Glas  
only glass  
Art. Nr. 6-1035



**Mushroom**

inkl. Glas + Basis  
incl. glass + base  
Art. Nr. 6-1010

nur Glas  
only glass  
Art. Nr. 6-1040

Die Basis ist im Grundpaket enthalten. Ladestationen, Trafos, Verbindungskabel und optionales Equipment müssen separat dazubestellt werden. Die Artikelnummern finden Sie auf Seite 231.

The base will be included in the basic package. Charger, adapter, connection wire and the optional equipment are ordered separately. Please check the list on page 231 for item numbers.



LEDs der neuesten Generation erzeugen ein angenehmes, warmes Licht für eine romantische Atmosphäre und verbrauchen dabei so wenig Energie, dass sie ohne störende Kabel auskommen. Je nach persönlicher Vorliebe sind die LEDs zudem in drei Stufen dimmbar. Die Energieversorgung übernehmen leistungsfähige Akkus, die mittels Ladestation bei Bedarf wieder geladen werden können. Für die Gastronomie sind Ladestationen lieferbar, die bis zu 5 oder 30 Tischlampen gleichzeitig aufladen.

LEDs of the latest technology generate a pleasant, warm light for a romantic atmosphere and consume thereby as little energy, that they manage without interfering cables. Depending on personal preference the LEDs are also dimmable in three stages. The energy is supplied by powerful batteries that can be recharged by charger when needed. For restaurants charging stations are available who charge up to 5 or 30 table lamps simultaneously.





# Ambiente danlight®

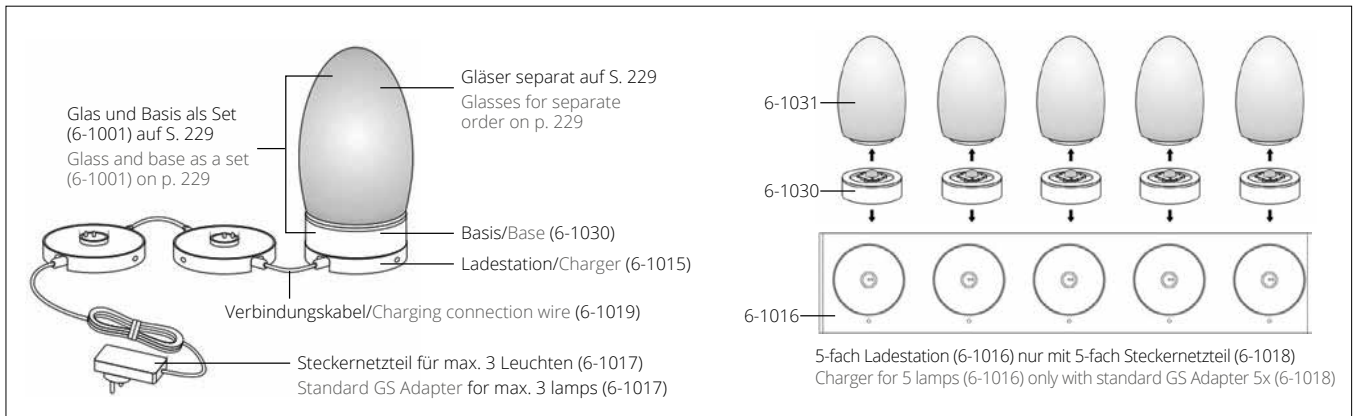

**1** Basis / Base

Ø 105 mm, H 38 mm

Art. Nr. 6-1030

Gläser separat auf Seite 229.  
Glasses for separate order on page 229.



**5** Steckernetzteil

Standard GS adapter

Für max. 3 Ladestationen 6-1015.  
For max. 3 chargers 6-1015.

Art. Nr. 6-1017



**2** Ladestation / Charger

Ø 105 mm, H 20 mm  
+ **5** (6-1017)

Art. Nr. 6-1015



**6** 5-fach Steckernetzteil

Standard GS adapter (5x)

Für max. 5 Ladestationen 6-1015 o. 1x  
5-fach Ladestation 6-1016.  
For max. 5 chargers 6-1015 or 1x charger  
for 5 lamps 6-1016.

Art. Nr. 6-1018



**3** 5-fach Ladestation

Charger for 5 lamps  
B 736 x T 150 x H 21 mm  
+ **6** (6-1018)

Art. Nr. 6-1016



**7** Verbindungskabel

Charging connection wire  
Für Ladestation 6-1015.  
For charger 6-1015.  
L 22,5 cm

Art. Nr. 6-1019



**4** FarbfILTER Set

Color filter set  
blau/blue  
grün/green  
gelb/yellow  
rot/red

Art. Nr. 6-1020



**8** 30-fach Ladestation Trolley

Trolley charger for 30 lamps  
Inklusive Trafos.  
Including adapter.  
B 1.007 x T 400 x H 900 mm

Art. Nr. 6-1021

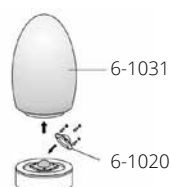

LED: **A+** 3W, ~3.000k

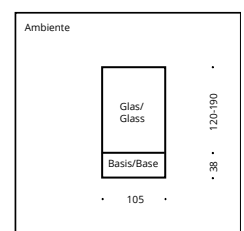
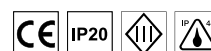







# Light On

Leselust ... ? Enjoy Reading ...?







Light On Silk



Light On Pisa



Light On Silk



Light On Pisa



# Light On

Schwere Regalleuchte und Buchstütze individuell zusammenstellbar, ob farbig, gold/silber oder auch Granit, Opalglas oder Silkschirm, integrierter Dimmer, mit transparentem Kabel, Schalter und Stecker, Filzboden, Gewicht 4,5 kg, inkl. Halogenlampe G9 matt, max. 33W ECO.

Heavy shelf lamp and bookend, individually combinable. Available in color, gold, silver, granite design or with silk shade. Integrated dimmer with transparent cable, switch and plug. Felt-covered base. Weight 4.5 kg including halogen lamp G9 opal. Max. 33 watts ECO.

Bitte jede Artikelnummer mit 6-240 beginnen	Korpus corpus Art.Nr. item no.	Flexarm (L) flexarm (l)	Köpfe heads
<b>6-240</b>	<b>60</b> Granit Optik granite design	<b>31</b> chrom chrome 30 cm	<b>3</b> Pisa® chrome G9/QT14: D → ~460lm 33W ECO ~2.700k
	<b>70</b> Weiß matt flat white		
	<b>80</b> Rot red	<b>32</b> nickelmatt nickel matt 30 cm	<b>5</b> Silk weiß Silk white E14: C → 20W, ~235lm ~2.700k
	<b>90</b> Blattgold Edition® gold leaf edition®		
	<b>91</b> Blattsilber Edition silver leaf edition	<b>33</b> gold Lack® gold finish® 30 cm	<b>7</b> Silk schwarz Silk black E14: C → 20W, ~235lm ~2.700k
		<b>9</b> Silk rot Silk red E14: C → 20W, ~235lm ~2.700k	



transparenter Schalter  
transparent switch



integrierter Dimmer  
integrated dimmer

Please attach  
**6-240**  
in front of  
each item  
number

Ⓞ Nur in Kombination miteinander bestellbar! Available in combination only!

Ⓢ 180° Reflektor optional für Glas Pisa, Art.-Nr. 9-204. 180° Baffle optional for glass Pisa, item number 9-204.



**Reflektor "Option":**  
Aluminium-Hochleistungsreflektor, einfache Montage durch Einschub in den Glastubus.

**Baffle "option":**  
High performance aluminium baffle, easy installation: slides into the glass tube.

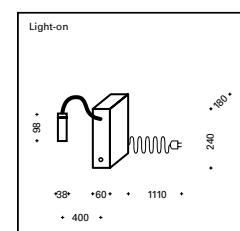





Flexlight Double Wall Silk



**Puk Flexlight:**  
Die Flexlight Serie mit  
Puk-Kopf finden Sie auf  
den Seiten 56 – 57.























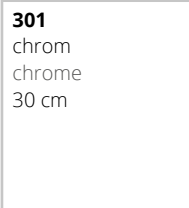







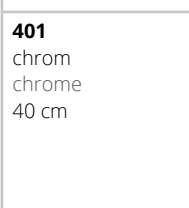









**Puk Flexlight:**  
You find the Flexlight  
Series with Puk head on  
page 56 – 57.

# Flexlight



Artikelnr. Beispiel für abgebildete Leuchte. Example of item-no. for the lamp pictured.

**3- + 70 + 401 + 05-S100R = 3-7040105-S100R**

Basis base Art.Nr. item no.		Flexarm flexarm Art.Nr. item no. Farbe color Länge length		Köpfe heads Art.Nr. item no.			
Bitte jede Artikelnummer mit 3- beginnen	<b>31</b> PlugS schwarz black 📖 238-239 	+		+	<b>01</b> Iglo G9/QT14: D → ~980lm 60W ECO ~2.900k 	<b>12</b> Shade E27: E → ~2.700k 60W, ~235lm 	
	<b>32</b> PlugW weiß white 📖 238-239 				<b>201</b> chrom chrome 20 cm 	<b>02</b> India G9/QT14: D → ~980lm 60W ECO ~2.900k 	<b>17</b> Rio GU10: D → 35W, ~230lm ~2.700k 
	<b>33</b> PlugST schwarz transp. transp. black 📖 238-239 				<b>202</b> nickelmatt nickel matt 20 cm 	<b>03</b> Pisa® G9/QT14: D → ~460lm 33W ECO ~2.700k 	<b>19</b> Ariane GU10: D → 35W, ~230lm ~2.700k 
	<b>34</b> PlugWT weiß transp. transp. white 📖 238-239 				<b>301</b> chrom chrome 30 cm 	<b>05</b> Silk Schirm Silk shade E14: C → ~2.700k 20W, ~235lm 	<b>20</b> Apollo GU10: D → 35W, ~230lm ~2.700k 
	<b>20</b> Fix® 📖 240 				<b>302</b> nickelmatt nickel matt 30 cm 	<b>10</b> Edison mini E14: C → ~2.700k 20W, ~235lm 	<b>21</b> Telstar GU10: D → 35W, ~230lm ~2.700k 
	<b>40</b> Wall® 📖 241 				<b>401</b> chrom chrome 40 cm 	<b>11</b> Edison E27: E → ~2.700k 60W, ~235lm 	<b>22</b> Challenge GU10: D → 35W, ~230lm ~2.700k 
	<b>41</b> Double Wall® nur in 30er Länge only in length 30 📖 242 				<b>402</b> nickelmatt nickel matt 40 cm 	Schirmfarben für Silk (Chinz) Shade colors for Silk (Chinz) 	
	<b>50</b> Spring® 📖 243 					<b>SI-100DB</b> 	
	<b>60</b> Screw® 📖 244 					<b>SI-100RO</b> 	
	<b>70</b> Table® nur in 40er Länge, only in length 40 📖 245 					<b>SI-100HB</b> 	
		<b>SI-100GB</b> 					
		<b>SI-100TR</b> 					
		<b>SI-100GR</b> 					
		<b>SI-100 O</b> 					
		<b>SI-100 V</b> 					
		<b>SI-100 S</b> 					
		<b>SI-100 W</b> 					
		<b>SI-100 R</b> 					

- ① Umbau zum Spiegeleinbau, conversion for mirror mounting
- ② 180° Reflektor optional für Glas Pisa, 180° baffle optional for glass Pisa
- ③ "Touch me" Dimmer, "Touch me" dimmer
- ④ Kippschalereinbau, dip switch fitting

- Art.-Nr. 9-3002 chrom (chrome), Art.-Nr. 9-3009 nickelmatt (nickel matt)
- Art.-Nr. 9-204
- Art.-Nr. 2-00888
- Art.-Nr. 2-00883





Flexlight Plug Rio



Flexlight Plug Pisa



Flexlight Plug Silk



Flexlight Plug Shade



# Flexlight Plug

Steckerleuchte in chrom und nickelmatt, mit weißem Opalglas und Schalter in weiß, schwarz oder transparent.

Socket lamp in chrome or nickel matt design with white opal glass, switch available in white, black or transparent.



Flexlight Plug Apollo, nickel matt



Flexlight Plug Edison-mini, chrome



Flexlight Plug Telstar, nickel matt



Stecker wahlweise in:  
Weiß (W), Schwarz (S),  
Weiß-Transparent (WT),  
Schwarz-Transparent (ST)

Plug optionally in:  
white (W), black (S),  
transparent white (WT)  
transparent black (ST)

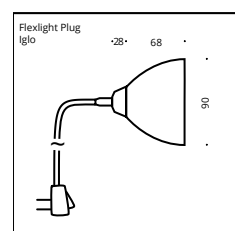



# Flexlight Fix

Spiegelklemmleuchte mit Flexarm, in chrom und nickelmatt, für Spiegelstärke 3-9 mm. Variantenübersicht auf Seite 237.

Clip lamp for mirrors (thickness 3-9mm) with flexible arm, chrome or nickel matt design. Survey of models on page 237.



Flexlight Fix in 3 Längen, Flex Light in 3 lengths



Flexlight Fix India

**Reflektor "Option":** Aluminium-Hochleistungsreflektor, einfache Montage durch Einschub in den Glastubus.

**Baffle "option":** High performance aluminium baffle, easy installation: slides into the glass tube.

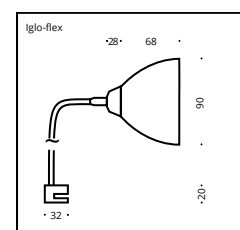



# Flexlight Wall

Wand-, Deckenleuchte mit 1 oder 2 Flexarmen, in chrom und nickelmatt. Variantenübersicht auf Seite 237.

Wall-, ceiling lamp with one or two flexible arms, in chrome or nickel matt design. Survey of models on page 237.



Flexlight Wall Pisa



Flexlight Wall Silk

**Reflektor "Option":** Aluminium-Hochleistungsreflektor, einfache Montage durch Einschub in den Glastubus.

**Baffle "option":** High performance aluminium baffle, easy installation: slides into the glass tube.

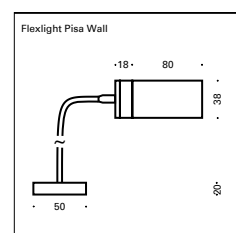

# Flexlight Double Wall

Wand-, Deckenleuchte mit 2 Flexarmen, in chrom und nickelmatt.

Wall-, ceiling lamp with two flexible arms, in chrome or nickel matt design.



Flexlight Double Wall Silk



Flexlight Double Wall Pisa, chrome



Flexlight Double Wall Silk



**Reflektor "Option":** Aluminium-Hochleistungsreflektor, einfache Montage durch Einschub in den Glastubus.

**Baffle "option":** High performance aluminium baffle, easy installation: slides into the glass tube.

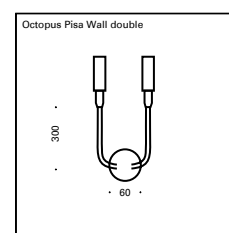



# Flexlight Spring

Federklemmleuchte, mit Flexarm, Opalglas, transparentem Kabel und Schalter. Variantenübersicht auf Seite 237.

Spring-clip lamp with flexible arm, opal glass, transparent cable and switch. Survey of models on page 237.

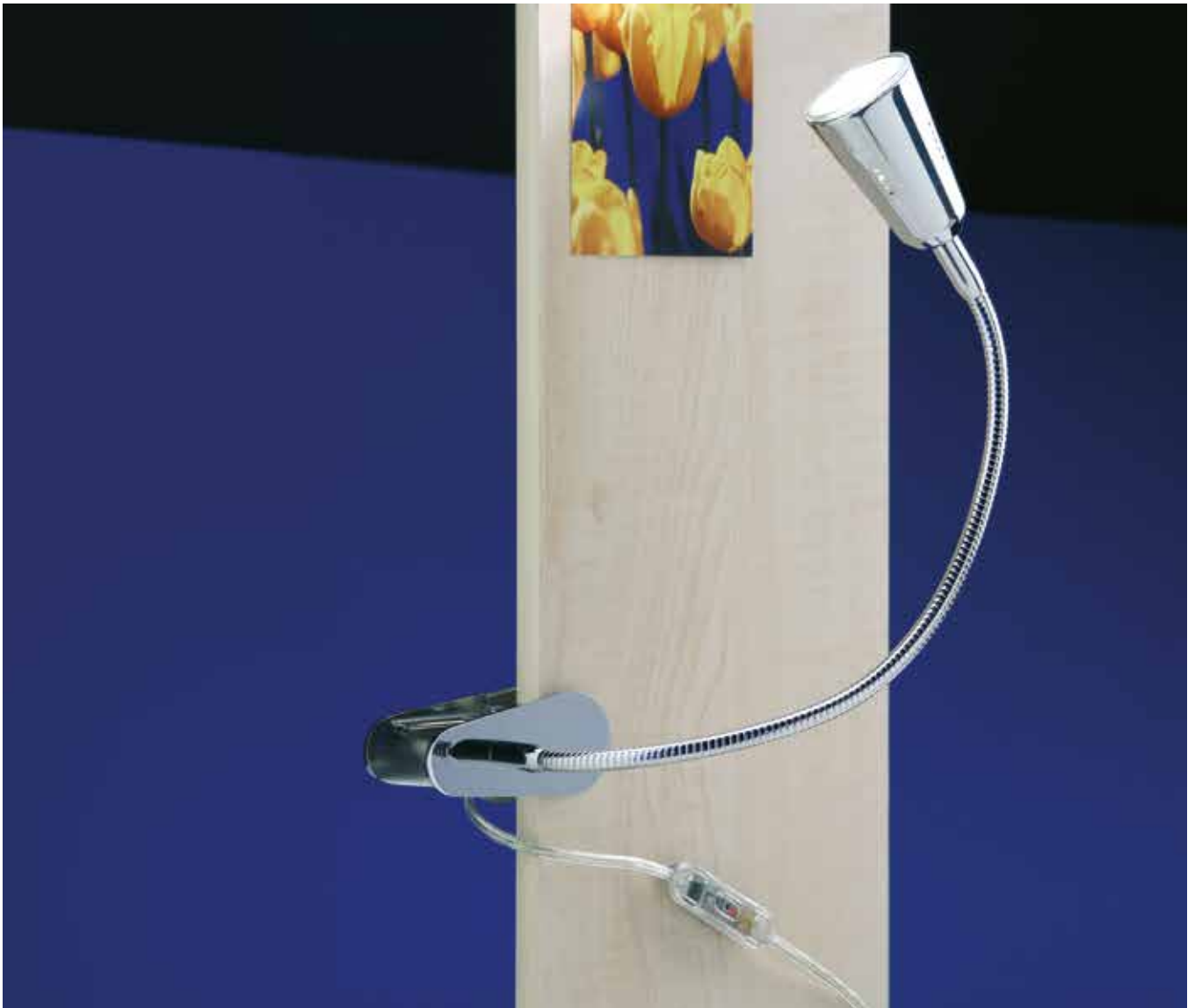

Flexlight Spring Rio



**Reflektor "Option":** Aluminium-Hochleistungsreflektor, einfache Montage durch Einschub in den Glastubus.

**Baffle "option":** High performance aluminium baffle, easy installation: slides into the glass tube.



**Touchme:** transparenter Schnurdimmer mit Memofunktion (optional)

**Touchme:** transparent cable dimmer with memory function (optional)

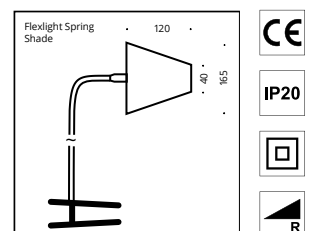



# Flexlight Screw

Schraubklemmleuchte, mit Flexarm, Opalglas, transparentem Kabel und Schalter Variantenübersicht auf Seite 237.

Screw-clip lamp with flexible arm, opal glass, transparent cable and switch. Survey of models on page 237.



Flexlight Screw Pisa



**Touchme:**  
transparenter Schnurdimmer  
mit Memofunktion (optional)

**Touchme:**  
transparent cable dimmer with  
memory function (optional)



**Reflektor "Option":** Aluminium-Hochleistungsreflektor, einfache Montage durch Einschub in den Glastubus.

**Baffle "option":** High performance aluminium baffle, easy installation: slides into the glass tube.

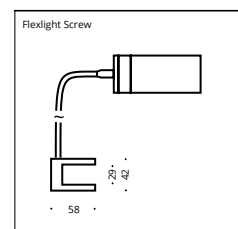



# Flexlight Table

Tischleuchte mit Flexarm, Opalglas, transparentem Kabel und Schalter. Variantenübersicht auf Seite 237.

Table lamp with flexible arm, opal glass, transparent cable and switch. Survey of models on page 237.



Flexlight Table Shade, Pisa & Rio

Flexlight Table Silk



**Reflektor "Option":** Aluminium-Hochleistungsreflektor, einfache Montage durch Einschub in den Glastubus.

**Baffle "option":** High performance aluminium baffle, easy installation: slides into the glass tube.

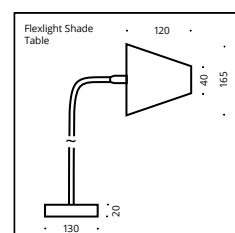



Glaslight Pisa Double



Spotlight Plug Telstar



Glasslight Pisdouble, Pisa & India



Spotlight Spring Silk



# Spotlight & Glasslight

Artikelnr. Beispiel für abgebildete Leuchte. Example of Item-No. for the lamp pictured.

**2- + 40 + 01 + 03 = 2-400103**



Bitte jede Artikelnummer mit 2- beginnen	Basis base Art.Nr. item no.		+	Oberfläche surface		+	Köpfe heads Art.Nr. item no.		
	Art.Nr. item no.	Image		Art.Nr. item no.	Image		Art.Nr. item no.	Image	Image
Please attach 2- in front of each item number	<b>31</b> PlugS schwarz black 📖 250		+	<b>01</b> chrom chrome	+	<b>01</b> lglo G9/QT14: <b>D</b> 60W ECO, ~980lm ~2.900k		<b>17</b> Rio GU10: <b>D</b> 35W, ~230lm ~2.700k	
	<b>32</b> PlugW weiß white 📖 250			<b>02</b> India G9/QT14: <b>D</b> 60W ECO, ~980lm ~2.900k			<b>19</b> Ariane GU10: <b>D</b> 35W, ~230lm ~2.700k		
	<b>33</b> PlugST schwarz transp. transp. black 📖 250			<b>03</b> Pisa® G9/QT14: <b>D</b> 33W ECO, ~460lm ~2.700k			<b>20</b> Apollo GU10: <b>D</b> 35W, ~230lm ~2.700k		
	<b>34</b> PlugWT weiß transp. transp. white 📖 250			<b>05</b> Silk Schirm® Silk shade® E14: <b>C</b> ~2.700k 20W, ~235lm			<b>21</b> Telstar GU10: <b>D</b> 35W, ~230lm ~2.700k		
	<b>20</b> Fix 📖 248/251			<b>10</b> Edison mini E14: <b>C</b> ~2.700k 20W, ~235lm			<b>22</b> Challenge GU10: <b>D</b> 35W, ~230lm ~2.700k		
	<b>40</b> Wall® 📖 249/251			<b>11</b> Edison E27: <b>E</b> ~2.700k 60W, ~235lm			<b>32</b> Bulb G9/QT14: <b>D</b> 33W ECO, ~460lm, ~2.700k		
	<b>50</b> Spring® 📖 253			<b>12</b> Shade E27: <b>E</b> ~2.700k 60W, ~235lm			<b>31</b> Bulb Double G9/QT14: <b>D</b> 2 x 33W ECO, ~460lm, ~2.700k		
<b>60</b> Screw® 📖 252		<b>30</b> Pisa Double® G9/QT14: <b>D</b> 2 x 33W ECO, ~460lm, ~2.700k		<b>Pisa Double IP44</b> G9/QT14: <b>D</b> 2 x 33W ECO, ~460lm, ~2.700k					

Pisa Double mit IP44-Abdeckung  
Pisa Double with IP44-covering

Art.-Nr. item-no. 2-XX XX 30 IP44

- Ⓞ Umbau zum Spiegeleinbau, conversion for mirror mounting
- Ⓞ 180° Reflektor optional für Glas Pisa, 180° baffle optional for glass Pisa
- Ⓞ "Touch me" Dimmer, "Touch me" dimmer
- Ⓞ Kippschalteinbau, dip switch fitting
- Ⓞ Silkschirm nur als Deckenleuchte einsetzbar, Silk shade only as ceiling lamp applicable.
- Ⓞ Weitere Schirm-Farben für die Silk finden Sie auf Seite 237. You can find more colors for the silk shades on page 237.

- Art.-Nr. 9-3002 chrom (chrome), 9-3009 nickelmatt (nickel matt)
- Art.-Nr. 9-204
- Art.-Nr. 2-00888
- Art.-Nr. 2-00883



# Glasslight Fix

Spiegelklemmleuchte, dreh- und schwenkbar (außer Bulb), mit Opalglas, in chrom und nickelmatt, für Spiegelstärke 3-9 mm, Hochvolt, max. 60 Watt, G9 - matt. Variantenübersicht auf Seite 247.

Clip lamp for mirrors (thickness 3-9 mm), rotatable and tiltable (except for Bulb), with opal glass, in chrome or nickel matt design, high voltage, max 50 watts, G9 matt. Survey of models on page 247.



Pisa Double Fix, chrome



Bulb Fix, chrome



Iglo, Pisa & India Fix, chrome



**Reflektor "Option":**  
Aluminium-Hochleistungsreflektor, einfache Montage durch Einschub in den Glasstubus.

**Baffle "option":**  
High performance aluminium baffle, easy installation: slides into the glass tube.

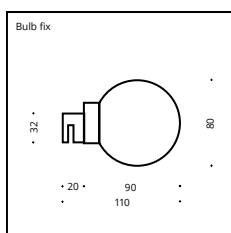



# Glasslight Wall

Wand- und Deckenleuchte, dreh- und schwenkbar (außer Bulb), mit Opalglas, in chrom und nickelmatt, Hochvolt, max. 60Watt, G9 - matt. Variantenübersicht auf Seite 247.

Lamp for walls and ceilings, rotatable and tiltable (except for Bulb), with opal glass, in chrome or nickel matt design, high voltage, max 60 watts, G9 matt. Survey of models on page 247.



Pisa Wall



Bulb Wall



Pisa Double IP44



Pisa Double

**Reflektor "Option":**  
Aluminium-Hochleistungsreflektor, einfache Montage durch Einschub in den Glastubus.

**Baffle "option":**  
High performance aluminium baffle, easy installation: slides into the glass tube.

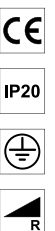
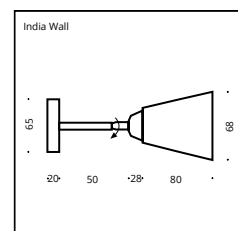

# Spotlight Plug

Steckerstrahler in chrom und nickelmatt, dreh- und schwenkbar, mit Schalter in weiß, schwarz oder transparent, max. 50 Watt, GU10. Variantenübersicht auf Seite 247.

Socket spotlight, in chrome or nickel matt design, rotatable and tiltable with switches in white, black or transparent, max. 50 watts, GU 10. Survey of models on page 247.



Ariane Plug, chrome



Telstar Plug, chrome matt

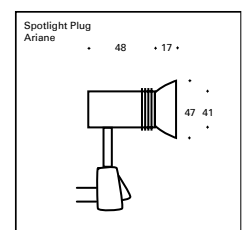





# Spotlight Wall & Fix

Ansteckstrahler für Spiegel, Hochvolt, für Spiegelstärken 3-9 mm. Aufbaustrahler für Wand und Decke, dreh- und schwenkbar, wahlweise in Chrom- oder Nickelmattausführung, inkl. Leuchtmittel 50 Watt GU10. Variantenübersicht auf Seite 247.

Clip light, high voltage, for mirrors (thickness 3-9 mm). Surface mounting spotlight, for walls and ceilings, rotatable and tiltable, in chrome or nickel matt design. Including lamp 50 watts GU 10. Survey of models on page 247.



Silk Wall, chrome matt



Ariane Wall,



Ariane Fix, chrome



Telstar Fix, nickelmatt

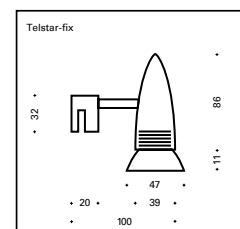
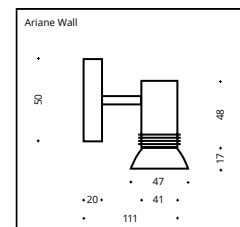



# Glasslight & Spotlight Screw

Schraubklemmleuchte in Opalglas oder Schraubklemmstrahler, Spot dreh- und schwenkbar, mit transparentem Kabel und Schalter. Variantenübersicht auf Seite 247.

Screw-clip lamp, opal glass or spot rotatable and tiltable, with transparent cable and switch. Survey of models on page 247.



Glasslight Screw Pisadouble



Spotlight Screw Challenge



**Touchme:**  
transparenter Schnurdimmer  
mit Memofunktion (optional)

**Touchme:**  
transparent cable dimmer with  
memory function (optional)



**Reflektor "Option" Baffle "option"**

**Richtungsweisend:**  
Aluminium-Hochleistungsreflektor, einfache  
Montage durch Einschub in den Glastubus.

**Multidirectional:**  
High performance aluminium baffle, easy  
installation: slides into the glass tube.

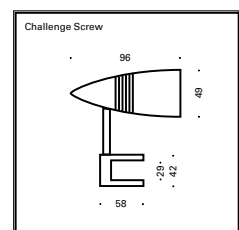
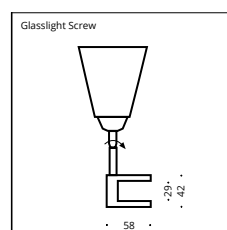



# Glasslight & Spotlight Spring

Federklemmleuchte in Opalglas oder Federklemmstrahler (Spot dreh- und neigbar) mit transparentem Kabel und Schalter. Variantenübersicht auf Seite 247.

Spring-clip lamp, opal glass or spot rotatable and tiltable, with transparent cable and switch. Survey of models on page 247.



Glasslight Spring Bulb



Spotlight Spring Ariane



**Touchme:**  
transparenter Schnurdimmer mit Memofunktion (optional)

**Touchme:**  
transparent cable dimmer with memory function (optional)



**Reflektor "Option" Baffle "option"**

**Richtungsweisend:**  
Aluminium-Hochleistungsreflektor, einfache Montage durch Einschub in den Glastubus.

**Multidirectional:**  
High performance aluminium baffle, easy installation: slides into the glass tube.

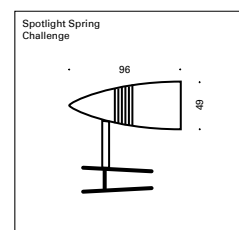
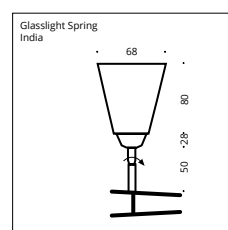









# Living Outdoor Collection



Octopus Outdoor



Puk Maxx Outdoor chrome



Light Stone





# Leuchten für den Außenbereich

## Outdoor Lamps

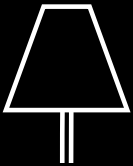

Octopus Outdoor 261

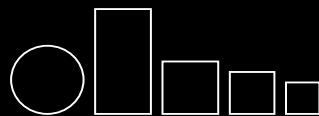

Lightstone Beton 265



Lightstone Basalt 267



Lightstone Cristal 269

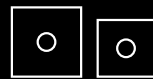

Lightstone Lichtpunkt 271

Lightstone Rund 272  
Lightstone Norm H & S

Technisches Zubehör 273  
Technical accessories

Diese Leuchten finden Sie unter: Puk World

You can find this lamps at: Puk World



Puk Outdoor Wall 115



Puk Outdoor Plus & Turn 115



Puk Maxx Outdoor Wall 119



Puk Maxx Outdoor Plus & Turn 119

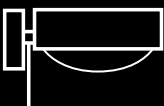

Puk Meg Maxx Outdoor Wall 123



Puk Meg Maxx Outdoor Plus 123







# Puk, Puk Maxx & Puk Meg Maxx Outdoor

Weitere Angaben zu den Puk, Puk Maxx & Puk Meg Maxx Outdoor Leuchten finden Sie auf den Seiten 112 – 125.

Further information about the Puk, Puk Maxx & Puk Meg Maxx Outdoor lamps you will find on pages 112 – 125.



Puk Wall Outdoor, chrome matt 114 – 117



Puk Turn Outdoor, chrome 114 – 117



Puk Plus Outdoor, chrome 114 – 117



Puk Maxx Wall Outdoor, drehbar pivotable 118-121



Puk Maxx Turn Outdoor, nur drehbar pivotable only 118-121



Puk Maxx Plus Outdoor, chrome matt 118-121



Puk Meg Maxx Wall Outdoor, nickel matt 122-125



Puk Meg Maxx Plus Outdoor chrome 122-125

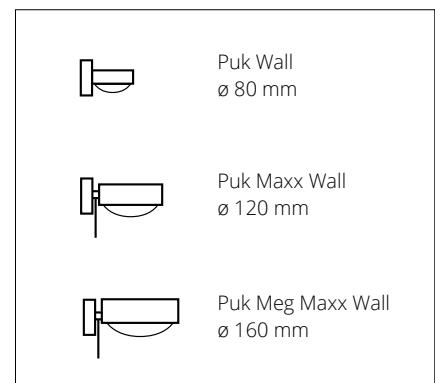





Octopus Outdoor Big Foot



# Octopus Outdoor

Die lichtechten Schirme des Modells »Village« aus Polycarbonat leuchten in den Farben Gelb, Orange, Rot, Grün und Weiß. Die Arme sind biegsam und in zwei Standardlängen, sowie in Längen nach Wunsch lieferbar. Der im Leuchtenschaft integrierte Erdspeiß ermöglicht es, die »Octopus Outdoor« in das Erdreich zu stecken oder mit einem vorgestochenen Loch in den Boden einzulassen.

The fadeless shades of the Village-model made of polycarbonate shine in colors of yellow, orange, red, green and white. Arms are bendable and available in two standard lengths as well as in customized lengths. The integrated ground-skewer enables you to poke the lamp into the ground or to fix it in a pre-lanced hole.



Octopus Outdoor Village



Octopus Outdoor



Big Foot

Halogen E27:  ~2.700k	Ausführung design	Maße in mm dimensions in mm
19-01130 19-01180	Octopus Outdoor 33W ECO, ~405lm Octopus Outdoor 33W ECO, ~405lm	1.300 + 400 Erdlänge ground-length 1.800 + 400 Erdlänge ground-length
19-10	Verlängerung, lengthening piece	je/each 100
19-01-GE 19-01-GR 19-01-O 19-01-R 19-01-W	Village Schirm gelb, shade yellow Schirm grün, shade green Schirm orange, shade orange Schirm rot, shade red Schirm weiß, shade white	ø ca. 285 ø ca. 285 ø ca. 285 ø ca. 285 ø ca. 285
19-0111	Big Foot Objektfuß für max. 11 Leuchten base for max 11 lamps	ø ca. 400 3 x Erdspeiß / spike L=500 Edelstahl / stainless steel

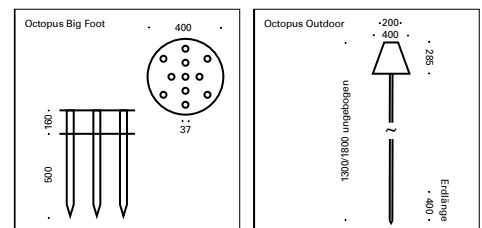



# Light Stone

Wegweisende und dekorative Lichtelemente im Pflaster.  
Pioneering and decorative light elements in the patch.



Light Stone Basalt



## Neue Lichtstein LED Technologie.

Unsere Lichtsteine verfügen jetzt über ein separat geschütztes System mit komplett vergossener LED. Dadurch wird eine extreme Wasserdichte im IP44 Bereich gewährleistet, die den Lichtstein noch resistenter gegen Abnutzung durch Umwelteinflüsse macht.

## New Lightstone LED Technologie.

Our lightstones now have a separately protected system with fully encapsulated LED. As a result, an extreme IP44 water density is ensured, that makes the lightstone more resistant to wear and tear caused by environmental factors.



## Modell-/Formatübersicht Survey of formats and models

### Beton

Kunststeinoptik, Cast Stone Design  
Maße (Dimensions) in mm

①②③④

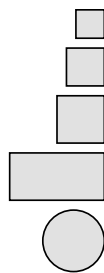

B x L x H (w x l x h)

60 x 60 x 80

80 x 80 x 80

100 x 100 x 60

100 x 200 x 60

130 Ø 84



### Basalt

Natursteinoptik, Virgin Stone Design  
Maße (Dimensions) in mm

①②③④



B x L x H (w x l x h)

50 x 60 x 50

60 x 70 x 60

70 x 85 x 70

120 x 120 x 80

140 x 140 x 80

160 x 160 x 90



### Cristal

Granitsteinoptik, Granite Stone Design  
Maße (Dimensions) in mm

①②③○



B x L x H (w x l x h)

50 x 60 x 50

60 x 70 x 55

70 x 80 x 70

95 x 95 x 60



### Lichtpunkt

Naturstein, Virgin Stone  
Maße (Dimensions) in mm

①○③○



B x L x H (w x l x h)

80 x 80 x 80

100 x 100 x 90



Technik Technology LED: **A+** ~5.300k, IP68

① 0,3 Watt LED ~19lm 12V/DC

② 1 Watt LED ~81lm 12V/DC

③ LED in den Farben: weiß, blau, gelb, rot, grün  
LED color options: white, blue, yellow, red, green

④ Lichtstein durchgefärbt in blau, gelb, rot, grün (LED weiß)  
Illuminated Stone, solid-colored in: blue, yellow, red, green (LED white)

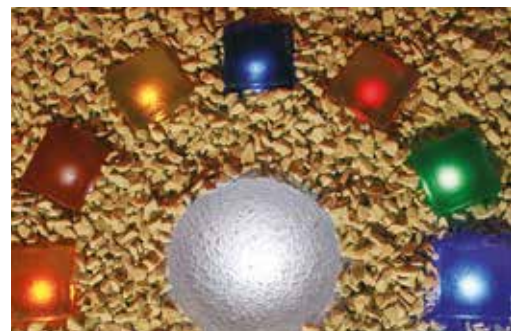



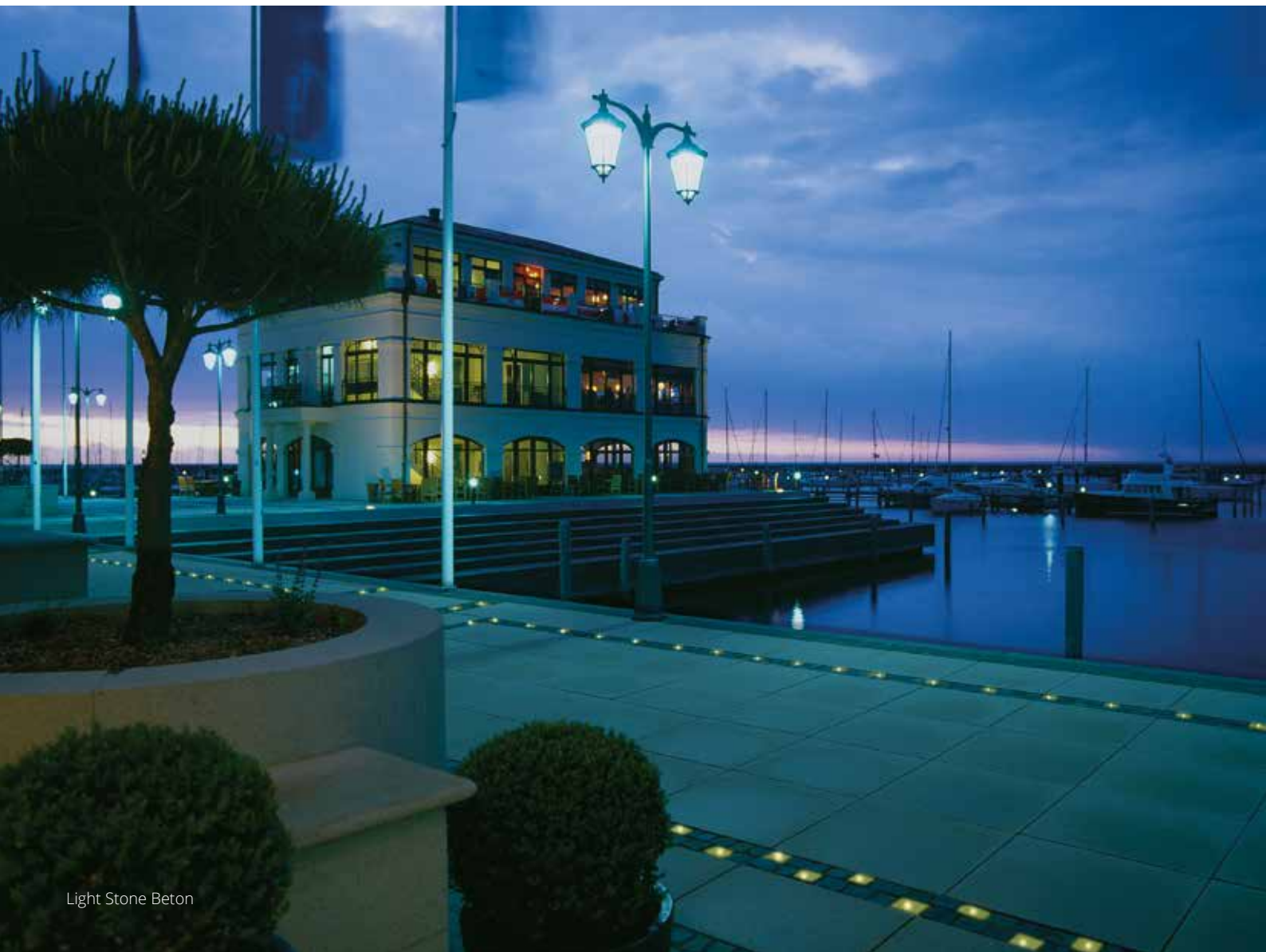
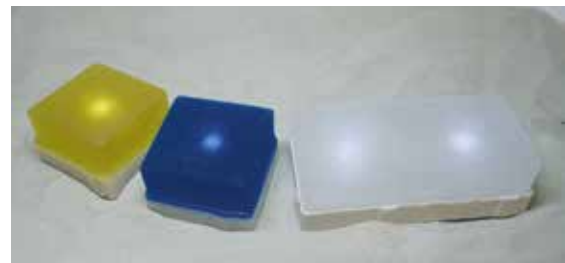

Light Stone Beton



# Light Stone Beton

Pflasterstein, Kunststeinoptik mit Anprallschutz, Hochleistungs LED-technik, ca. 0,3 oder 1 Watt (+), 12 V-DC, befahrbar (private Auffahrt/Fußgängerzone), schlagzäh, lichtstabilisiert. Bei 1 Watt LED bitte ein (+) der Artikelnummer anfügen, Variante glasklar auch mit farbiger LED lieferbar, bitte ein (F) anhängen.

Cobblestone; Cast Stone Design with impact protection, High Performance LED technology, approx. 0.3 or 1 watt (+), 12 V DC. Fit for traffic (private driveway/pedestrian zone), impact resistant, light stabilised, for 1 watt version please attach (+) to the item number, Crystal clear model also available with colored LED, then please attach (F) to the item number.



Der original Light Stone Pflasterstein ist die konsequente Umsetzung der Hochleistungs-LED-Technik.

The original Light Stone cobblestone is the perfect realisation of high performance LED technology.

In Beton- oder Basaltsteinoptik und in verschiedenen Größen fügt er sich als Wegweiser oder dekoratives Lichtelement in alle Pflasterflächen ein.

In concrete or basalt stone design and in different sizes it blends in perfectly with all cobblestone surfaces as guidelight or decorative light element.



Art. Nr. (+) <sup>®</sup> item no. (+) <sup>®</sup>	Farbe Color glasklar (F) <sup>®</sup> o. durchgefärbt crystal clear or solid-colored	Leistung output 0,3 od. 1 Watt (+) <sup>®</sup>	L x B x H in mm l x w x h in mm
12-016060	glasklar, crystal clear (F) <sup>®</sup>	1 x 0,3 Watt	60 x 60 x 80 <sup>®</sup>
12-016060b	kobaltblau, china blue	1 x 0,3 Watt	60 x 60 x 80 <sup>®</sup>
12-016060ge	sonnengelb, sun yellow	1 x 0,3 Watt	60 x 60 x 80 <sup>®</sup>
12-016060r	rubinrot, ruby red	1 x 0,3 Watt	60 x 60 x 80 <sup>®</sup>
12-016060gr	smaragdgrün, emerald green	1 x 0,3 Watt	60 x 60 x 80 <sup>®</sup>
12-018080	glasklar, crystal clear (F) <sup>®</sup>	1 x 0,3 Watt	80 x 80 x 80 <sup>®</sup>
12-018080b	kobaltblau, china blue	1 x 0,3 Watt	80 x 80 x 80 <sup>®</sup>
12-018080ge	sonnengelb, sun yellow	1 x 0,3 Watt	80 x 80 x 80 <sup>®</sup>
12-018080r	rubinrot, ruby red	1 x 0,3 Watt	80 x 80 x 80 <sup>®</sup>
12-018080gr	smaragdgrün, emerald green	1 x 0,3 Watt	80 x 80 x 80 <sup>®</sup>
12-01100100	glasklar, crystal clear (F) <sup>®</sup>	1 x 0,3 Watt	100 x 100 x 60 <sup>®</sup>
12-01100100b	kobaltblau, china blue	1 x 0,3 Watt	100 x 100 x 60 <sup>®</sup>
12-01100100ge	sonnengelb, sun yellow	1 x 0,3 Watt	100 x 100 x 60 <sup>®</sup>
12-01100100r	rubinrot, ruby red	1 x 0,3 Watt	100 x 100 x 60 <sup>®</sup>
12-01100100gr	smaragdgrün, emerald green	1 x 0,3 Watt	100 x 100 x 60 <sup>®</sup>
12-01100200	glasklar, crystal clear (F) <sup>®</sup>	2 x 0,3 Watt	100 x 200 x 60 <sup>®</sup>
12-01100200b	kobaltblau, china blue	2 x 0,3 Watt	100 x 200 x 60 <sup>®</sup>
12-01100200ge	sonnengelb, sun yellow	2 x 0,3 Watt	100 x 200 x 60 <sup>®</sup>
12-01100200r	rubinrot, ruby red	2 x 0,3 Watt	100 x 200 x 60 <sup>®</sup>
12-01100200gr	smaragdgrün, emerald green	2 x 0,3 Watt	100 x 200 x 60 <sup>®</sup>

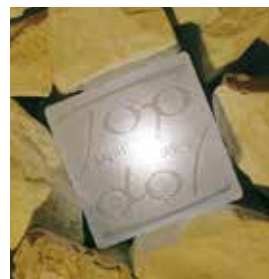

① Maße beziehen sich auf Leuchtenkörper (sichtbare Fläche), Aufprallschutz + 5 mm.

Dimensions relate to illuminant (visible area), impact protection + 5 mm.

② Sollmaße für Standart Betonrechteck Pflaster 10 x 10 bzw. 10 x 20. Nominal dimensions for standard concrete rectangle cobblestone 10 x 10 or 10 x 20.

③ Bei 1 Watt LED bitte ein (+) der Artikelnummer anfügen. Please attach a (+) to the item number for 1 watt LED.

④ Variante glasklar auch mit farbiger LED lieferbar, bitte ein (F) anhängen. Crystal clear model also available with colored LED, please attach (F) to item no.





Light Stone Basalt



# Light Stone Basalt

Pflasterstein, Natursteinoptik mit Anprallschutz, Hochleistungs LED-Technik, ca. 0,3 oder 1 Watt (+), 12 V-DC, befahrbar (private Auffahrt/Fußgängerzone), schlagzäh, lichtstabilisiert. Bei 1 Watt LED bitte ein (+) der Artikelnummer anfügen, Variante glasklar auch mit farbiger LED lieferbar, bitte ein (F) anhängen.

Cobblestone, virgin stone design with impact protection, high performance LED technology, approx. 0.3 or 1 watt (+), 12 V DC. Fit for traffic (private driveway/pedestrian zone), impact resistant, light stabilised, for 1 watt version please attach (+) to the item number, Crystal clear model also available with colored LED, then please attach (F) to the item number.

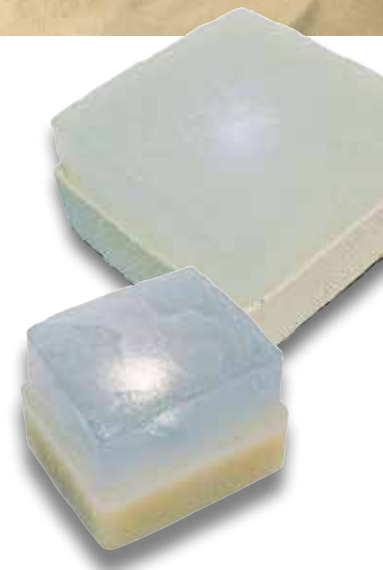

Art. Nr. (+) <sup>®</sup> item no. (+) <sup>®</sup>	Farbe color glasklar (F) <sup>®</sup> o. durchgefärbt crystal clear or solid-colored	Leistung output 0,3 od. 1 Watt (+) <sup>®</sup>	L x B x H in mm l x w x h in mm
11-015060	glasklar, crystal clear (F) <sup>®</sup>	1 x 0,3 Watt	50 x 60 x 50 <sup>®</sup>
11-015060b	kobaltblau, china blue	1 x 0,3 Watt	50 x 60 x 50 <sup>®</sup>
11-015060ge	sonnengelb, sun yellow	1 x 0,3 Watt	50 x 60 x 50 <sup>®</sup>
11-015060r	rubinrot, ruby red	1 x 0,3 Watt	50 x 60 x 50 <sup>®</sup>
11-015060gr	smaragdgrün, emerald green	1 x 0,3 Watt	50 x 60 x 50 <sup>®</sup>
11-016070	glasklar, crystal clear (F) <sup>®</sup>	1 x 0,3 Watt	60 x 70 x 60 <sup>®</sup>
11-016070b	kobaltblau, china blue	1 x 0,3 Watt	60 x 70 x 60 <sup>®</sup>
11-016070ge	sonnengelb, sun yellow	1 x 0,3 Watt	60 x 70 x 60 <sup>®</sup>
11-016070r	rubinrot, ruby red	1 x 0,3 Watt	60 x 70 x 60 <sup>®</sup>
11-016070gr	smaragdgrün, emerald green	1 x 0,3 Watt	60 x 70 x 60 <sup>®</sup>
11-017085	glasklar, crystal clear (F) <sup>®</sup>	1 x 0,3 Watt	70 x 85 x 70 <sup>®</sup>
11-017085b	kobaltblau, china blue	1 x 0,3 Watt	70 x 85 x 70 <sup>®</sup>
11-017085ge	sonnengelb, sun yellow	1 x 0,3 Watt	70 x 85 x 70 <sup>®</sup>
11-017085r	rubinrot, ruby red	1 x 0,3 Watt	70 x 85 x 70 <sup>®</sup>
11-017085gr	smaragdgrün, emerald green	1 x 0,3 Watt	70 x 85 x 70 <sup>®</sup>
11-01120120	glasklar, crystal clear (F) <sup>®</sup>	2 x 0,3 Watt	120 x 120 x 80 <sup>®</sup>
11-01120120b	kobaltblau, china blue	2 x 0,3 Watt	120 x 120 x 80 <sup>®</sup>
11-01120120ge	sonnengelb, sun yellow	2 x 0,3 Watt	120 x 120 x 80 <sup>®</sup>
11-01120120r	rubinrot, ruby red	2 x 0,3 Watt	120 x 120 x 80 <sup>®</sup>
11-01120120gr	smaragdgrün, emerald green	2 x 0,3 Watt	120 x 120 x 80 <sup>®</sup>
11-01140140	glasklar, crystal clear (F) <sup>®</sup>	4 x 0,3 Watt	140 x 140 x 80 <sup>®</sup>
11-01140140b	kobaltblau, china blue	4 x 0,3 Watt	140 x 140 x 80 <sup>®</sup>
11-01140140ge	sonnengelb, sun yellow	4 x 0,3 Watt	140 x 140 x 80 <sup>®</sup>
11-01140140r	rubinrot, ruby red	4 x 0,3 Watt	140 x 140 x 80 <sup>®</sup>
11-01140140gr	smaragdgrün, emerald green	4 x 0,3 Watt	140 x 140 x 80 <sup>®</sup>
11-01160160	glasklar, crystal clear (F) <sup>®</sup>	4 x 0,3 Watt	160 x 160 x 80 <sup>®</sup>
11-01160160b	kobaltblau, china blue	4 x 0,3 Watt	160 x 160 x 80 <sup>®</sup>
11-01160160ge	sonnengelb, sun yellow	4 x 0,3 Watt	160 x 160 x 80 <sup>®</sup>
11-01160160r	rubinrot, ruby red	4 x 0,3 Watt	160 x 160 x 80 <sup>®</sup>
11-01160160gr	smaragdgrün, emerald green	4 x 0,3 Watt	160 x 160 x 80 <sup>®</sup>

Problemloses Verlegen, erdeinbautaugliches Elektroequipment (IP68) und die extrem lange Brenndauer (mittlere Brennstunden), zeichnen den Light Stone aus!

Problem-free installation, electronic equipment fit for subsurface installation (IP68) and the extremely long lighting hours (average lighting hours) are what the Light Stone stands for!

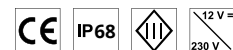

① Maße beziehen sich auf Leuchtenkörper (sichtbare Fläche), Aufprallschutz + 5 mm.

Dimensions relate to illuminant (visible area), impact protection + 5 mm.

② Bei 1 Watt LED bitte ein (+) der Artikelnummer anfügen. Please attach a (+) to the item number for 1 watt LED.

③ Variante glasklar auch mit farbiger LED lieferbar, bitte ein (F) anhängen. Crystal clear model also available with colored LED, please attach (F) to item no.





Als Leitlicht für Wege, in privaten Auf- und Einfahrten, als Randbegrenzung von gepflasterten Flächen oder als PKW-Stellplatzabgrenzung dient der Light Stone nicht nur als gestalterischer Akzent, sondern auch der Sicherheit an unübersichtlichen Stellen.

As a guarding light for pathways, private driveways and drive-ups, as a margin for parking spaces or cobblestone areas, the LightStone is not only a creative accent but also ensures safety in unclear areas.





# Light Stone Cristal

Pflasterstein, Granitsteinoptik, Hochleistungs LED-Technik, ca. 0,3 Watt oder 1Watt (+), 12 V-DC. Bei 1 Watt LED bitte ein (+) der Artikelnummer anfügen.

Cobblestone, granite stone design, high performance LED technology, approx. 0.3 or 1 watt (+), 12 V DC. For 1 watt version please attach (+) to the item number.



Art. Nr. (+) <sup>Ⓜ</sup> item no. (+) <sup>Ⓜ</sup>	Farbe glasklar mit LED color crystal clear with LED	Leistung output 0,3 od. 1 Watt (+) <sup>Ⓜ</sup>	L x B x H in mm l x w x h in mm
16-015060	weiß, white	1 x 0,3 Watt	50 x 60 x 50 <sup>Ⓜ</sup>
16-015060b	kobaltblau, china blue	1 x 0,3 Watt	50 x 60 x 50 <sup>Ⓜ</sup>
16-015060r	rubinrot, ruby red	1 x 0,3 Watt	50 x 60 x 50 <sup>Ⓜ</sup>
16-015060ge	sonnengelb, sun yellow	1 x 0,3 Watt	50 x 60 x 50 <sup>Ⓜ</sup>
16-015060gr	smaragdgrün, emerald green	1 x 0,3 Watt	50 x 60 x 50 <sup>Ⓜ</sup>
16-016070	weiß, white	1 x 0,3 Watt	60 x 70 x 55 <sup>Ⓜ</sup>
16-016070b	kobaltblau, china blue	1 x 0,3 Watt	60 x 70 x 55 <sup>Ⓜ</sup>
16-016070r	rubinrot, ruby red	1 x 0,3 Watt	60 x 70 x 55 <sup>Ⓜ</sup>
16-016070ge	sonnengelb, sun yellow	1 x 0,3 Watt	60 x 70 x 55 <sup>Ⓜ</sup>
16-016070gr	smaragdgrün, emerald green	1 x 0,3 Watt	60 x 70 x 55 <sup>Ⓜ</sup>
16-017090	weiß, white	1 x 0,3 Watt	70 x 80 x 70 <sup>Ⓜ</sup>
16-017090b	kobaltblau, china blue	1 x 0,3 Watt	70 x 80 x 70 <sup>Ⓜ</sup>
16-017090r	rubinrot, ruby red	1 x 0,3 Watt	70 x 80 x 70 <sup>Ⓜ</sup>
16-017090ge	sonnengelb, sun yellow	1 x 0,3 Watt	70 x 80 x 70 <sup>Ⓜ</sup>
16-017090gr	smaragdgrün, emerald green	1 x 0,3 Watt	70 x 80 x 70 <sup>Ⓜ</sup>
16-01100100	weiß, white	1 x 0,3 Watt	95 x 95 x 60 <sup>Ⓜ</sup>
16-01100100b	kobaltblau, china blue	1 x 0,3 Watt	95 x 95 x 60 <sup>Ⓜ</sup>
16-01100100r	rubinrot, ruby red	1 x 0,3 Watt	95 x 95 x 60 <sup>Ⓜ</sup>
16-01100100ge	sonnengelb, sun yellow	1 x 0,3 Watt	95 x 95 x 60 <sup>Ⓜ</sup>
16-01100100gr	smaragdgrün, emerald green	1 x 0,3 Watt	95 x 95 x 60 <sup>Ⓜ</sup>



① Maße beziehen sich auf Leuchtenkörper (sichtbare Fläche). Dimensions relate to illuminant (visible area), impact protection + 5 mm.

② Bei 1 Watt LED bitte ein (+) der Artikelnummer anfügen. Please attach a (+) to the item number for 1 watt LED.







# Light Stone Lichtpunkt

Naturpflasterstein, Punktstrahler, Hochleistungs LED-technik, in fünf Farben, ca. 0,3 Watt, 12 V-DC, befahrbar (private Auffahrt/Fußgängerzone), Lichtaustritt D = 30 mm.

Virgin stone, spotlight, high performance LED technology, available in five colors, approx. 0.3 watt, 12 V-DC, fit for traffic (private driveway/pedestrian zone), diameter of light emission D = 30 mm.



Wegweisend und abgrenzend weisen die Light Stones im Dunkeln zuverlässig den Weg.

Groundbreaking and outlining the Light Stone lights your way in the dark.

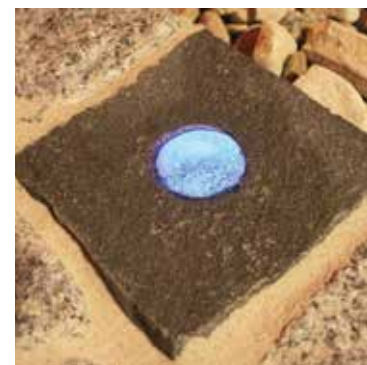

Art. Nr. item no.	Farbe (mit farbiger LED) color (with colored LED) Basalt Naturstein, virgin stone	Leistung output	L x B x H in mm l x w x h in mm
14-016565	weiß, white	1 x 0,3 Watt	ca. 80 x 80 x 80
14-016565b	kobaltblau, china blue	1 x 0,3 Watt	ca. 80 x 80 x 80
14-016565r	rubinrot, ruby red	1 x 0,3 Watt	ca. 80 x 80 x 80
14-016565ge	sonnengelb, sun yellow	1 x 0,3 Watt	ca. 80 x 80 x 80
14-016565gr	smaragdgrün, emerald green	1 x 0,3 Watt	ca. 80 x 80 x 80
14-019090	weiß, white	1 x 0,3 Watt	ca. 100 x 100 x 90
14-019090b	kobaltblau, china blue	1 x 0,3 Watt	ca. 100 x 100 x 90
14-019090r	rubinrot, ruby red	1 x 0,3 Watt	ca. 100 x 100 x 90
14-019090ge	sonnengelb, sun yellow	1 x 0,3 Watt	ca. 100 x 100 x 90
14-019090gr	smaragdgrün, emerald green	1 x 0,3 Watt	ca. 100 x 100 x 90

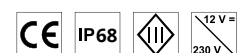



# Light Stone Rund

Pflasterstein Betonoptik mit Hochleistungs LED-Technologie, farblich durchgefärbt in rot, blau, grün, gelb oder gefrostet klar mit farbiger LED.

Cobblestone, concrete design, high performance LED technology, solid colored (red, blue, green, yellow, frosted clear with colored LED).

Art. Nr. item no.	Farbe/Ausführung color/design	Leistung output	ø x H in mm ø x h in mm
12-127	Betonoptik gefrostet klar, concrete design frosted clear	1 x 0,3 Watt	130 x 80
12-127b	kobaltblau, china blue	1 x 0,3 Watt	130 x 80
12-127ge	sonnengelb, sun yellow	1 x 0,3 Watt	130 x 80
12-127r	rubinrot, ruby red	1 x 0,3 Watt	130 x 80
12-127gr	smaragdgrün, emerald green	1 x 0,3 Watt	130 x 80
12-127(+)	Bei 1 Watt LED bitte ein (+) an die Artikelnummer anfügen Please attach a (+) to the item number for 1 watt LED		
12-127(F)	Bei Variante gefrostet klar mit farb. LED bitte ein F anfügen For frosted clear model please attach a (F) to the item number		



Light Stone Rund

# Light Stone Norma H & S



Light Stone Norma H



Light Stone Norma S



Art. Nr. item no.	Leistung output	L x B x H in mm l x w x h in mm
Norma H 12-130	2 x 0,3 Watt/ 2 x 1 Watt	160 x 190 x 58
Norma S 12-140	2 x 0,3 Watt/ 2 x 1 Watt	140 x 215 x 55

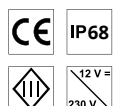



## Technisches Zubehör

## Technical accessories

Die Qualitätsmerkmale des Light Stone werden auch Sie überzeugen:

- Lange Brenndauer durch neueste LED-Technik
- 3 verschiedene Systeme: Basaltpflaster, Betonpflaster, Lichtpunkte in Naturstein
- Versch.Standardgrößen: 6 Basalt-, 4 Beton-Größen, alle in glasklar und 5 Farben
- Erdeinbautauglich: Light Stone und hochwertiges Installationsmaterial nach Schutzklasse IP 68 und IP 58 kann ohne Spezialwerkzeug verlegt werden
- Grundkörper mineralstoffbefüllt, seitlicher Anprallschutz: Light Stone kann im Verbund mit anderem Pflaster verlegt werden
- Hoher optischer und haptischer Anspruch; Basalt mit natursteinartiger Topographie und Oberfläche. Betonfarben mit hochbeständiger Granulatbeschichtung
- Durch Rechteckformate mit unterschiedlichen Kantenlängen gute Einfassung in den Pflasterverbund
- Hervorragendes Preis-/Leistungsverhältnis durch langjährige Erfahrungen und Innovationskraft in der Kunstharzverarbeitung
- Lichtstabilisiert und schlagzäh
- Systemprodukt: Sortimentsausbau durch Zubehör und Wegeleuchten
- Sondergrößen und -ausführungen in Stückzahlen für Objektausstattungen
- Rutschfestigkeitsklasse 3V (sehr hoher Haftreibungswert, Trittsicherheitswinkel über 35,1° mit hohem Schmutzverdrängungsraum)
- Keine Abstrahlung von UV-Licht
- Geringe Temperaturentwicklung am Leuchtmittel
- Auf ca. 40 m verlegbar ohne Spannungsverlust

Let the quality features of the Light Stone persuade you:

- Long lighting hours with new LED-technology.
- Three different systems: Basalt cobblestones, concrete cobblestones, spotlights in virgin stone
- Different standard sizes: 6 basalt sizes, 4 concrete sizes, all available in crystal clear or 5 different colors
- Suitable for subsurface fitting: Light Stone and high grade installation material according to protection category IP 68 and IP 58. Can be installed without specialty tools
- Base body filled with mineral compound, lateral impact protection: Light Stone can be installed together with other cobblestones
- High optical and haptic standard, basalt stone with virgin stone-like topography and surface. Concrete colored with highly stable granules coating
- Optimum integration in the cobblestone compound through rectangular formats with different edge lengths
- Extraordinary price-performance through our long-term experience in synthetic resin finish
- Light stabilised and impact resistant
- System product: A steady expansion of our product line by accessories and pathlights
- Special sizes and designs in quantities for object furnishing
- Skid resistance category 3V (high friction value, slip resistance angle more than 35,1 with large dirt displacement space)
- No radiance of UV light
- Small temperature development
- Layable at 40 m without power loss

Artikel model	Art. Nr. item no.	Ausführung design	L x B x H l x w x h
5 m Erdgummikabel	13-01005	2-polig für Niedervolt, schwarz, 2-pin for low voltage, black	5 m, 0, 75 qmm
10 m Erdgummikabel	13-01010	2-polig für Niedervolt, schwarz, 2-pin for low voltage, black	10 m, 0, 75 qmm
25 m Erdgummikabel	13-01025	2-polig für Niedervolt, schwarz, 2-pin for low voltage, black	25 m, 0, 75 qmm
50 m Erdgummikabel	13-01050	2-polig für Niedervolt, schwarz, 2-pin for low voltage, black	50 m, 0, 75 qmm
100 m Erdgummikabel	13-01100	2-polig für Niedervolt, schwarz, 2-pin for low voltage, black	100 m, 0, 75 qmm

- Bei mehreren Bestellungen Erdgummikabel, wird das Kabel immer in einem Stück geliefert-

- At higher order quantities of subsurface cables, the cable is always supplied in one piece-

Endverbinder, term.connector	13-01105	Endverbinder, terminal connector IP 68, 13 cm	
Trafo 4,6 Watt, IP 55	13-01101	inkl. Trafo, incl.transformator max. 3 Steine bei 1W, max. 12 Steine bei 0,3 W max. 3 1W-stones, max. 12 0,3W-stones	85 x 85 x 40 mm
Trafo 4,6 Watt, IP 68 transformator 3 watts	13-01102	inkl. Trafo und Kabelharz, incl. transformator and cable resin max. 3 Steine bei 1W, max. 12 Steine bei 0,3 W max. 3 1W-stones, max. 12 0,3W-stones	85 x 85 x 40 mm
Trafo 15 Watt, IP 55	13-01103	inkl. Trafo, incl.transformator max. 10 Steine bei 1W, max. 40 Steine bei 0,3 W max. 10 1W-stones, max. 40 0,3W-stones	85 x 130 x 40 mm
Trafo 15 Watt, IP 68 transformator 15 watts	13-01104	inkl. Trafo und Kabelharz, incl. transformator and cable resin max. 10 Steine bei 1W, max. 40 Steine bei 0,3 W max. 10 1W-stones, max. 40 0,3W-stones	85 x 130 x 40 mm

Gezeigte Lichtstein-Farben sind ein Hinweis auf das optische Finish und keine Eigenschaftszusicherung. Für die Richtigkeit von technischen Angaben, sowie Farbabweichungen wird keine Gewähr übernommen. Alle Maßangaben sind unverbindlich und können geringfügige Abweichungen aufweisen. Technische Änderungen vorbehalten.

Shown Lightstone colors are an indication of the optical design and no confirmation of character. No responsibility is taken for the correctness of technical data and alterations of color. All dimensions are non-committal and can be subject to minor deviations. Technical changes are subject to alteration.

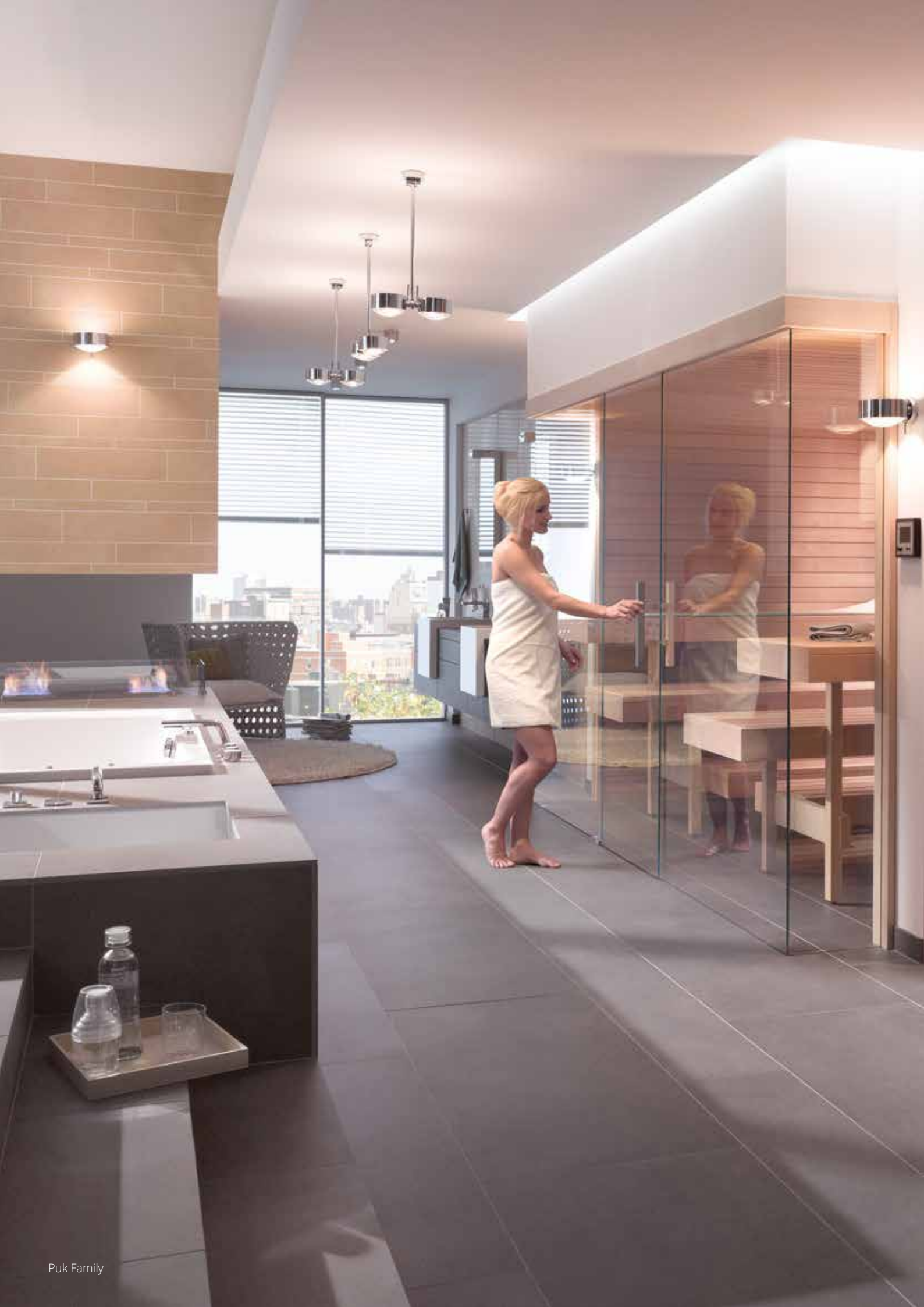



# Kataloge

Catalogs

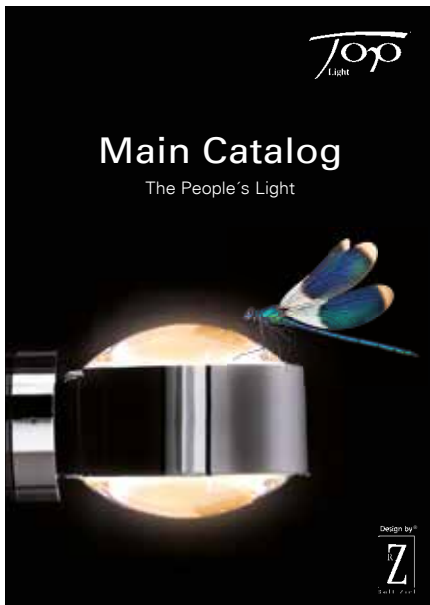

Hauptkatalog / Main Catalog:  
The People's Light A4 10-100

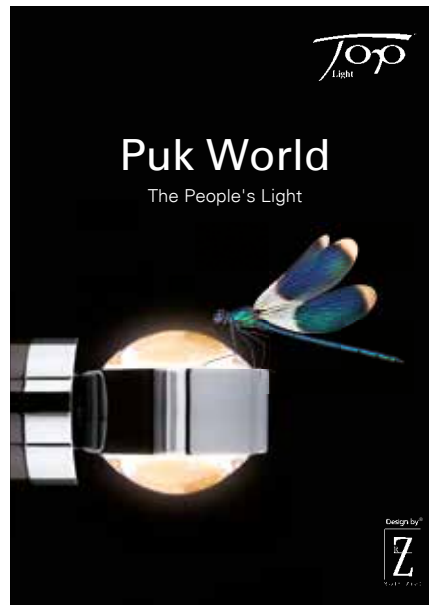

Only Puk:  
Puk World A4 10-103

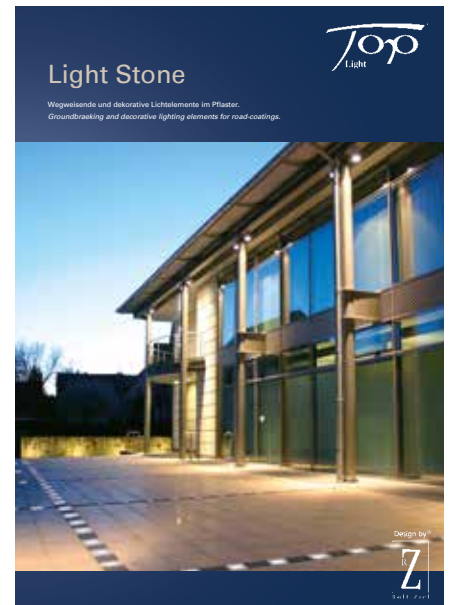

Only Light Stone:  
Light Stone A4 10-104



New Line A4 10-194



Puk World A6 10-153



Produktübersicht A6 10-102

Design by®



Rolf Ziel

*Rolf Ziel*

**Top**<sup>®</sup>  
Light



Art.-Nr. 10-100-3 April 2015

Hersteller (Manufacturer):

**Top Light e.K.**

Industriezentrum 100

32139 Spenge

fon +49 (0) 52 25 . 8 63 12 - 0

fax +49 (0) 52 25 . 8 63 12 - 10

[www.top-light.de](http://www.top-light.de)

[brief@top-light.de](mailto:brief@top-light.de)

